

CAREERS 360

PREPARATION **Series**

Completion of Figure

All Questions with Solutions

Q. 1 **Directions:** Which answer figure will combine with the pattern in the question figure?

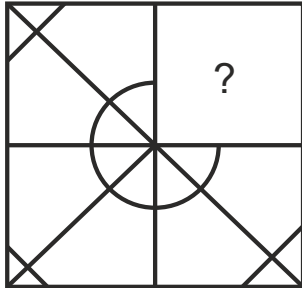

Option 1:

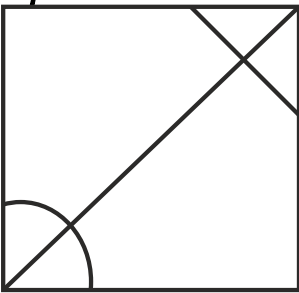

Option 2:



Option 3:

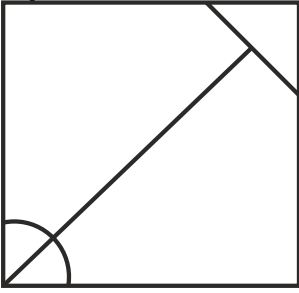

Option 4:

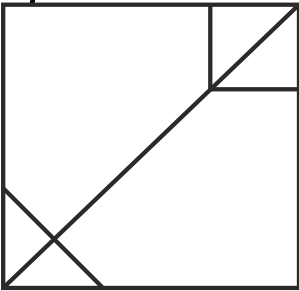

Correct Answer:

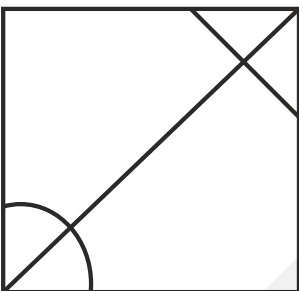

Solution:

On comparing the question figure and all the answer figures, the following figure will combine and make the complete pattern -

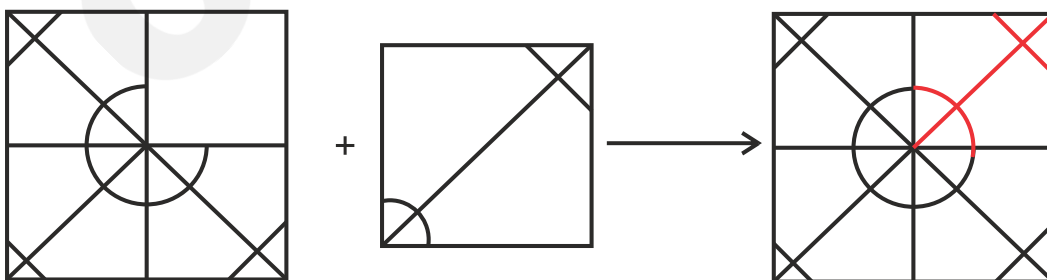

Hence, the **first option** is correct.

- Q. 2** **Directions:** Which answer figure will combine the pattern in the question figure?

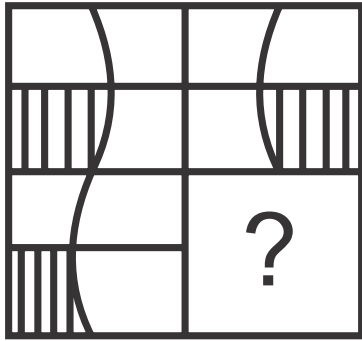

Option 1:

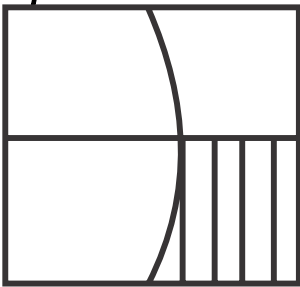

Option 2:



Option 3:

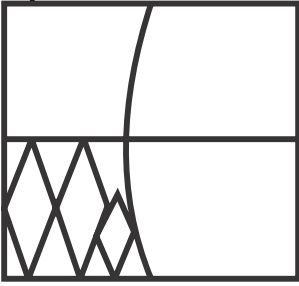

Option 4:

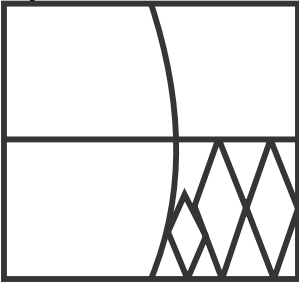

Correct Answer:

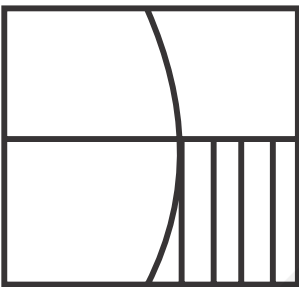

Solution:

On comparing the question figure and all the answer figures, the following figure will combine and make the complete pattern -

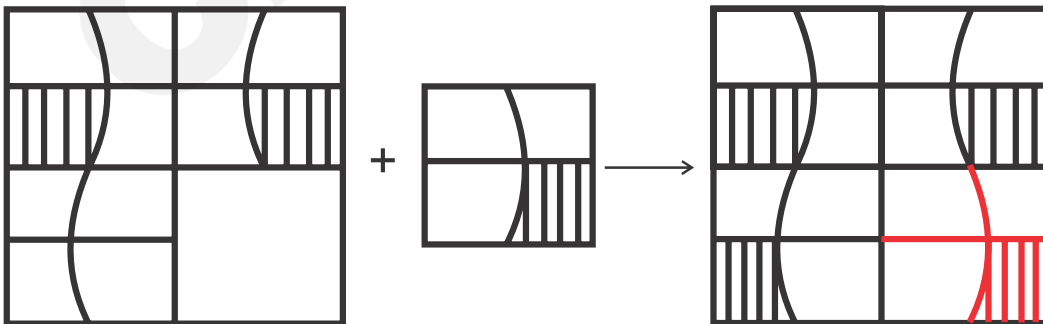

Hence, the **first option** is correct.

- Q. 3** **Directions:** Which answer figure will complete the pattern in the question figure?

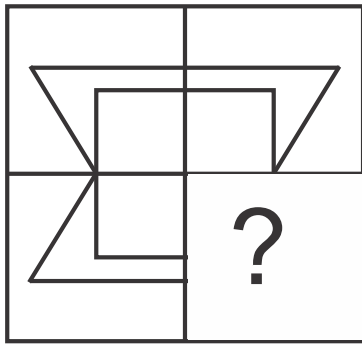

Option 1:

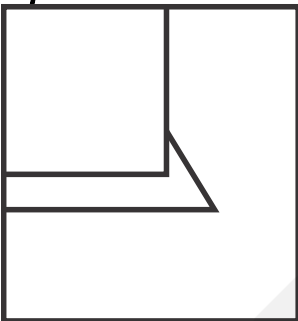

Option 2:

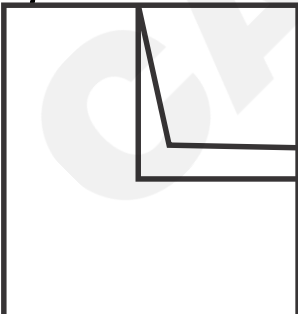

Option 3:

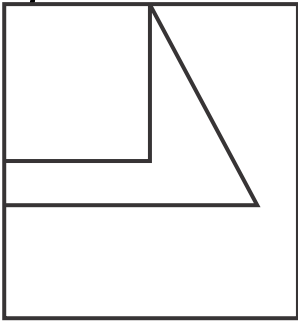

Option 4:

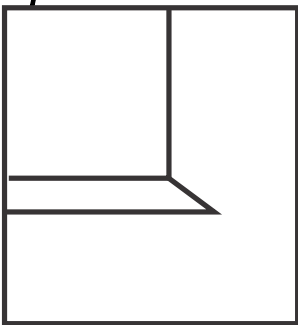

Correct Answer:

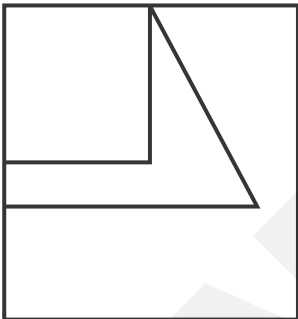

Solution:

On comparing the question figure and all the answer figures, the following figure will combine and make the complete pattern -

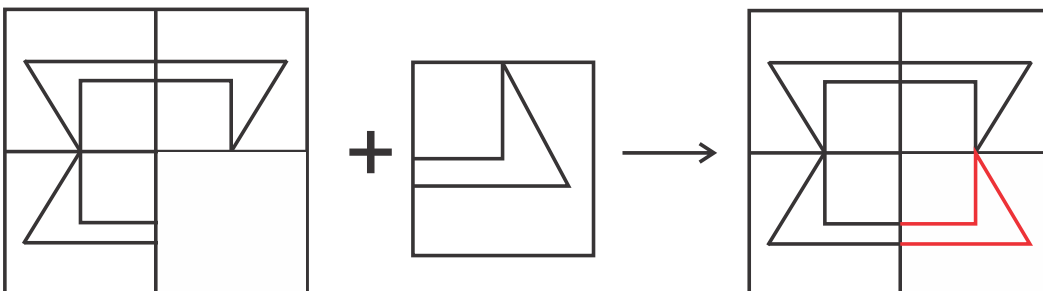

Hence, the **third option** is correct.

- Q. 4** **Directions:** Which answer figure will combine with the pattern in the question figure?

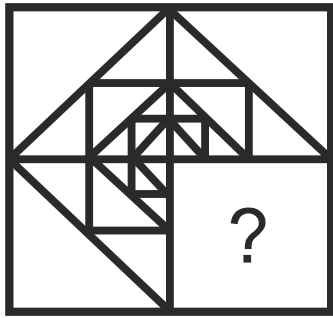

Option 1:

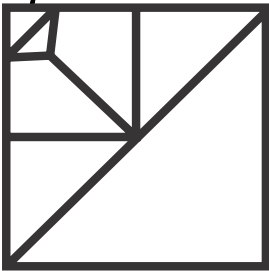

Option 2:

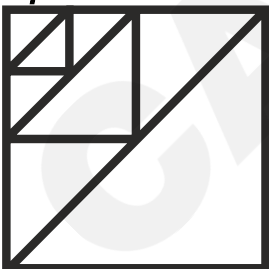

Option 3:

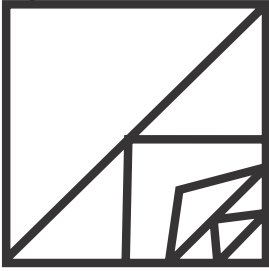

Option 4:

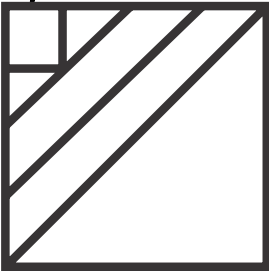

Correct Answer:

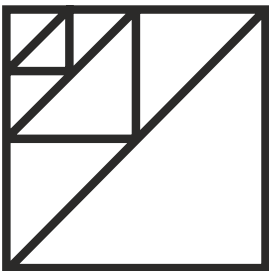

Solution:

On comparing the question figure and all the answer figures, the following figure will combine and make the complete pattern -

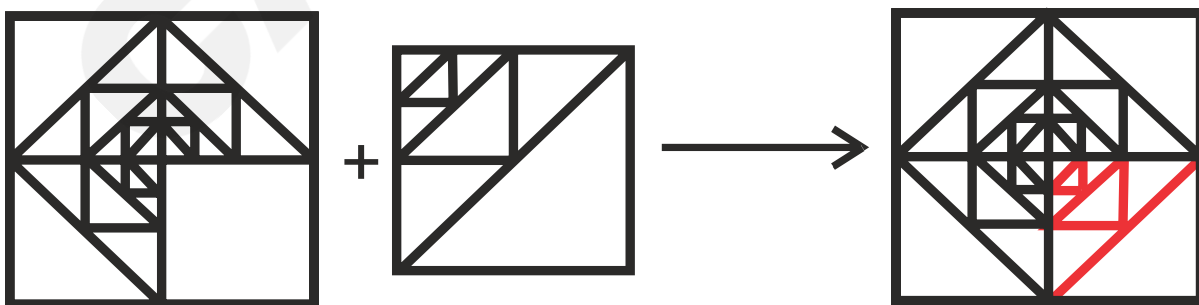

Hence, the **second option** is correct.

- Q. 5** **Directions:** Which answer figure will combine with the pattern in the question figure?

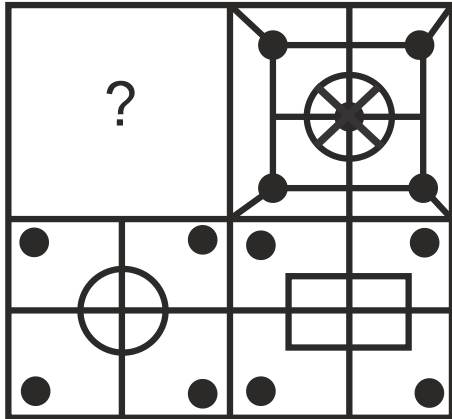

Option 1:

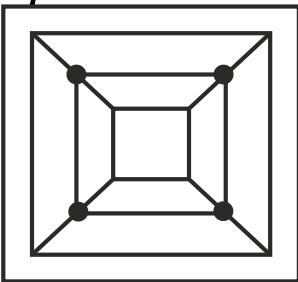

Option 2:

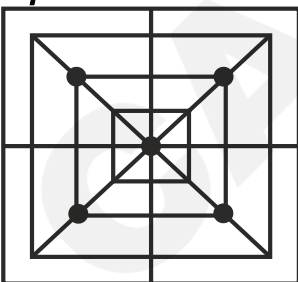

Option 3:

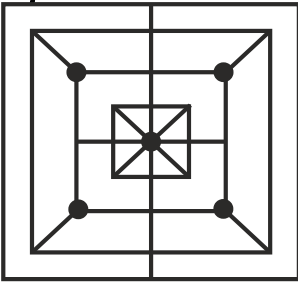

Option 4:

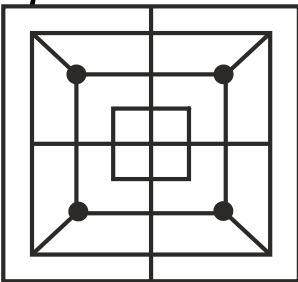

Correct Answer:

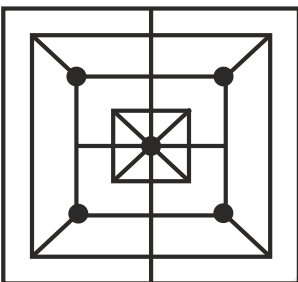

Solution:

On comparing the question figure and all the answer figures, the following figure will combine and make the complete pattern -

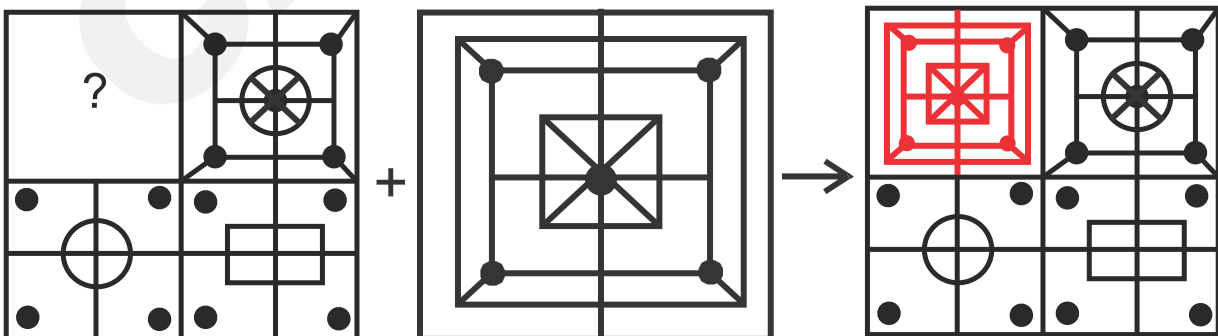

Hence, the **third option** is correct.

- Q. 6** **Directions:** Which answer figure will complete the pattern in the question figure?

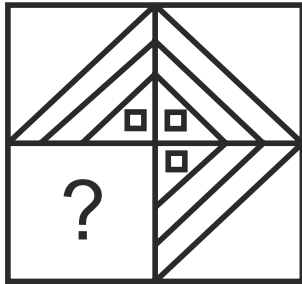

Option 1:

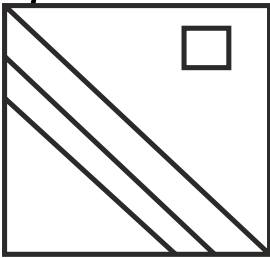

Option 2:

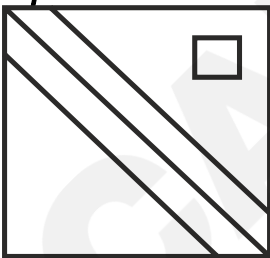

Option 3:

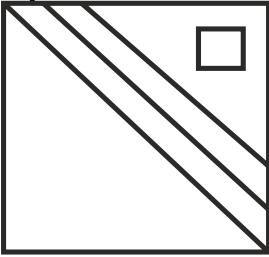

Option 4:

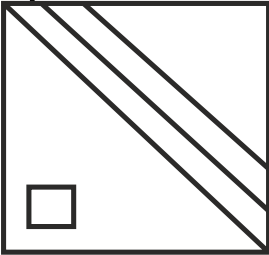

Correct Answer:

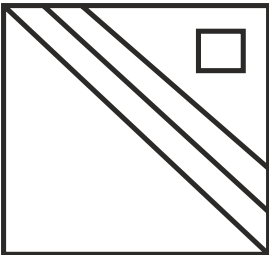

Solution:

On comparing the question figure and all the answer figures, the following figure will combine and make the complete pattern -

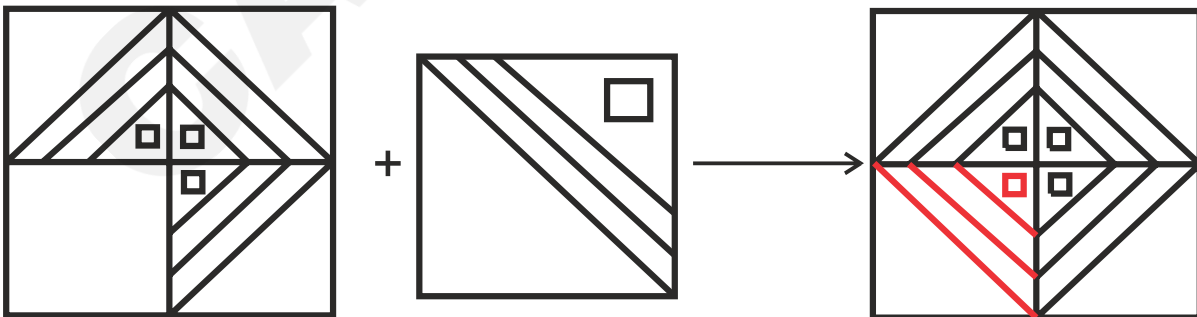

Hence, the **third option** is correct.

Q. 7 **Directions:** Which answer figure will complete the pattern in the question figure?

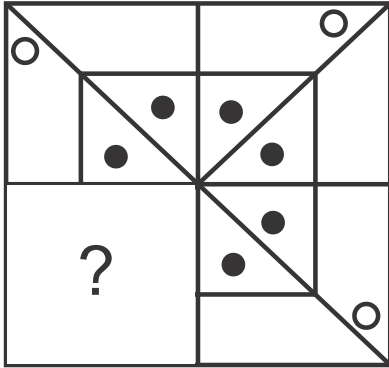

Option 1:

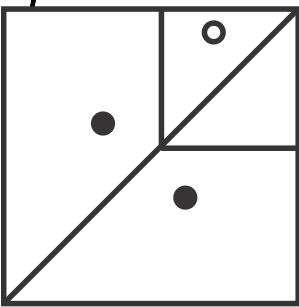

Option 2:

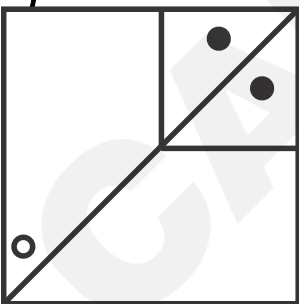

Option 3:

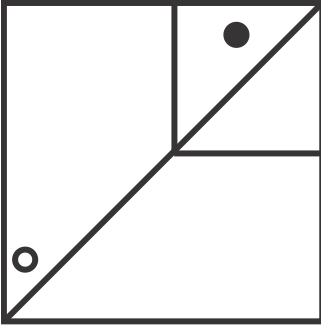

Option 4:

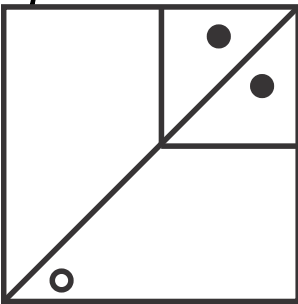

Correct Answer:

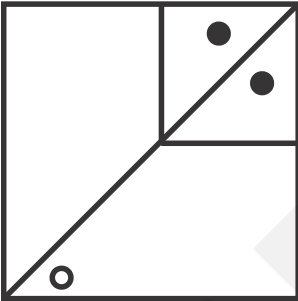

Solution:

On comparing the question figure and all the answer figures, the following figure will combine and make the complete pattern –

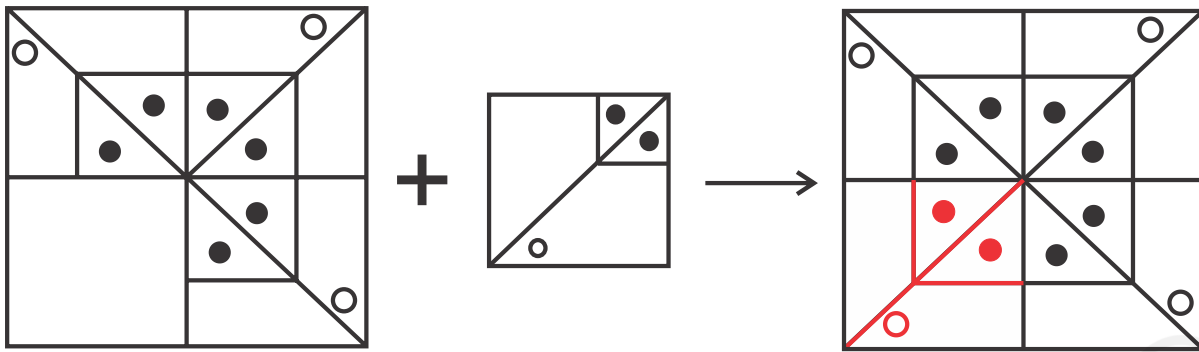

Hence, the **fourth option** is correct.

Q. 8 **Directions:** Which answer figure will complete the pattern in the question figure?

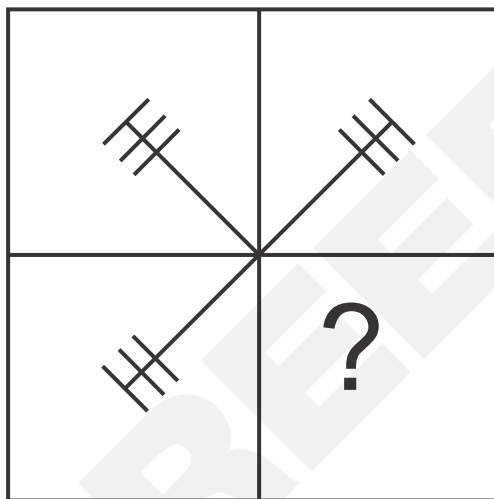

Option 1:

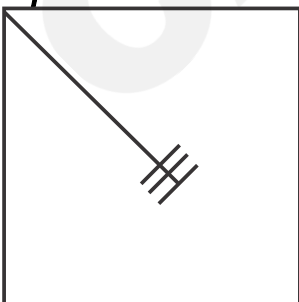

Option 2:

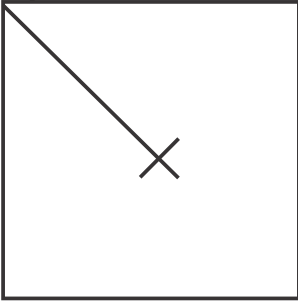

Option 3:

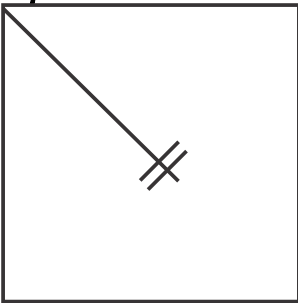

Option 4:

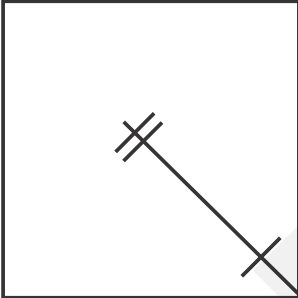

Correct Answer:

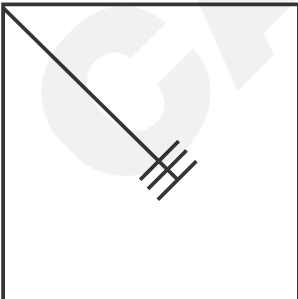

Solution:

On comparing the question figure and all the answer figures, the following figure will combine and make the complete pattern -

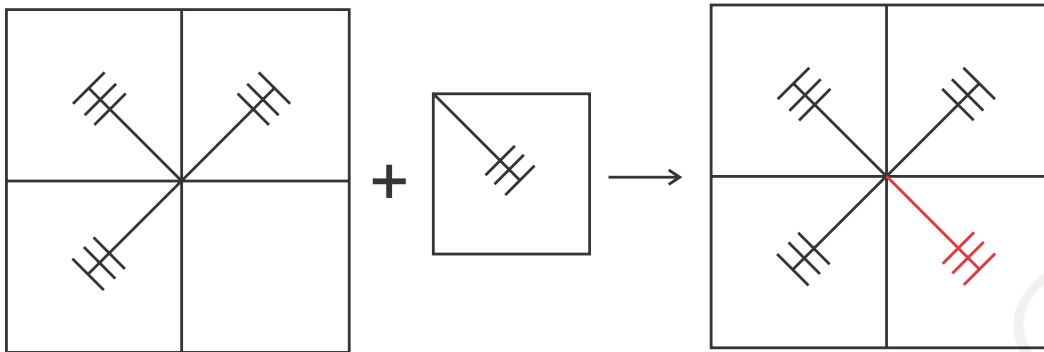

Hence, the **first option** is correct.

Q. 9 **Directions:** Which answer figure will complete the pattern in the question figure?

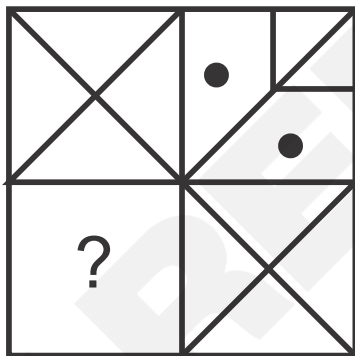

Option 1:

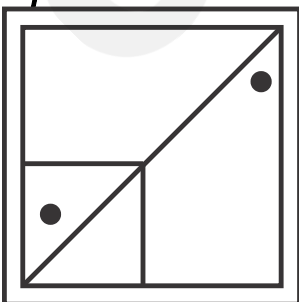

Option 2:

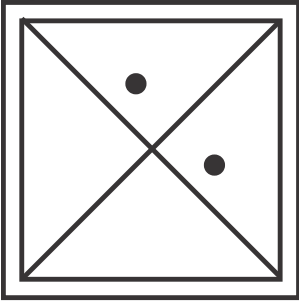

Option 3:

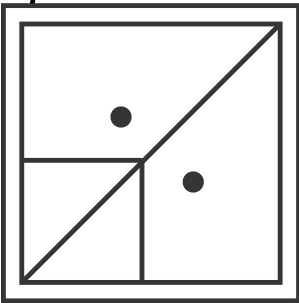

Option 4:

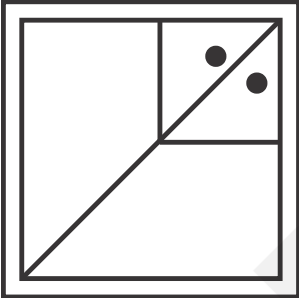

Correct Answer:

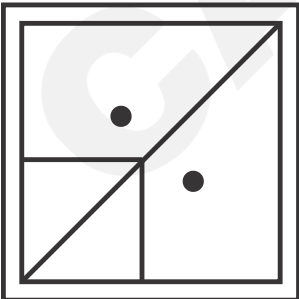

Solution:

On comparing the question figure and all the answer figures, the following figure will combine and make the complete pattern -

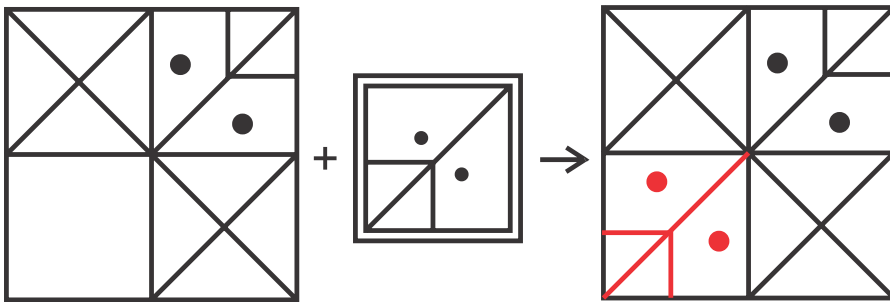

Hence, the **third option** is correct.

Q. 10 **Directions:** Which figure will complete the pattern in the given figure in the question?

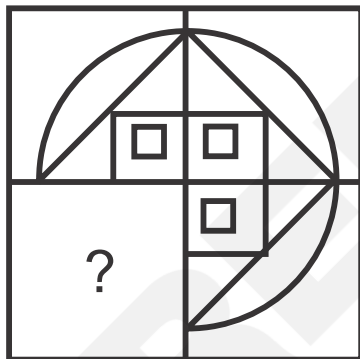

Option 1:

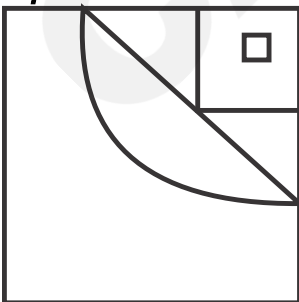

Option 2:

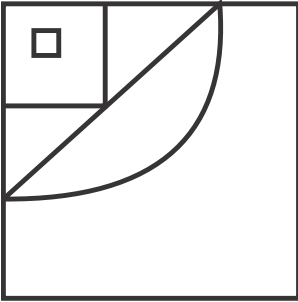

Option 3:

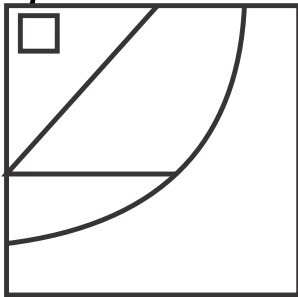

Option 4:

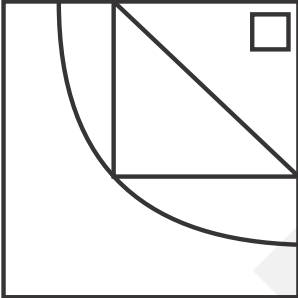

Correct Answer:

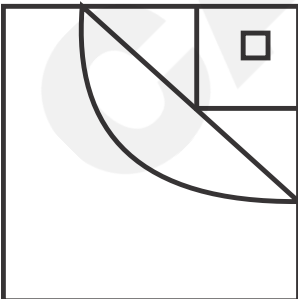

Solution:

On comparing the question figure and all the answer figures, the following figure will combine and make the complete pattern -

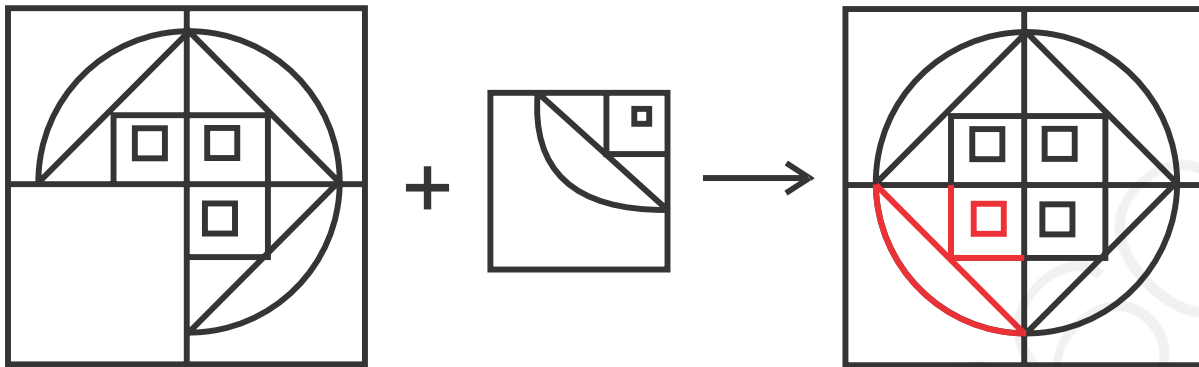

Hence, the **first option** is correct.

Q. 11 **Directions:** Which answer figure will complete the pattern in the question figure?

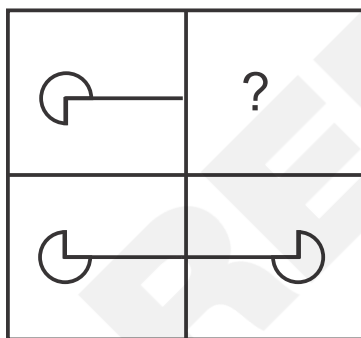

Option 1:

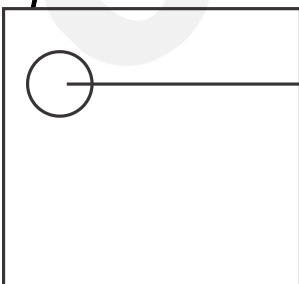

Option 2:

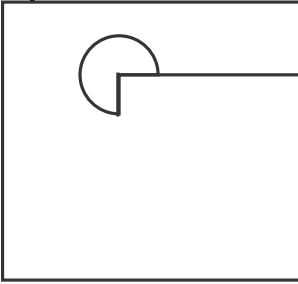

Option 3:

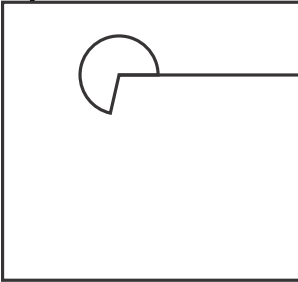

Option 4:

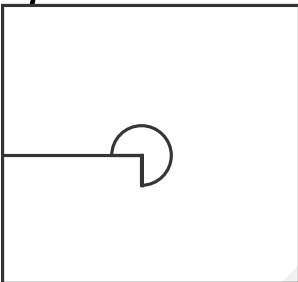

Correct Answer:

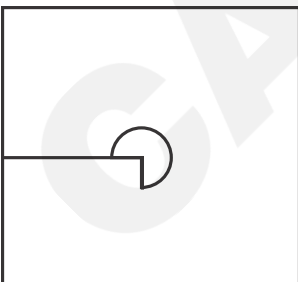

Solution:

On comparing the question figure and all the answer figures, the following figure will combine and make the complete pattern -

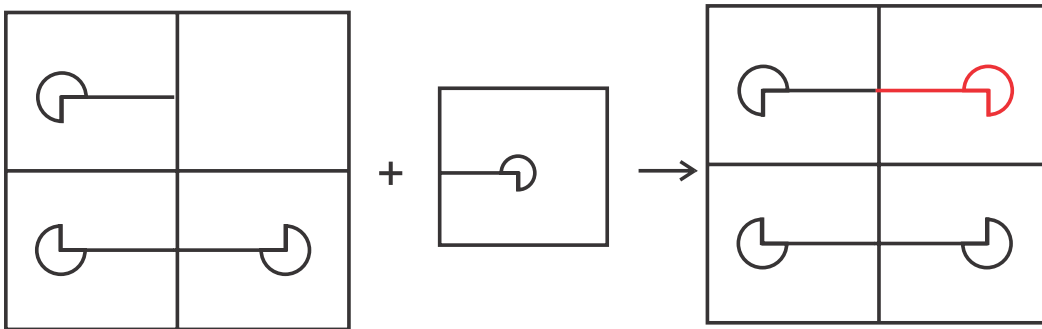

Hence, the **fourth option** is correct.

Q. 12 **Directions:** Which answer figure will complete the pattern in the question figure?

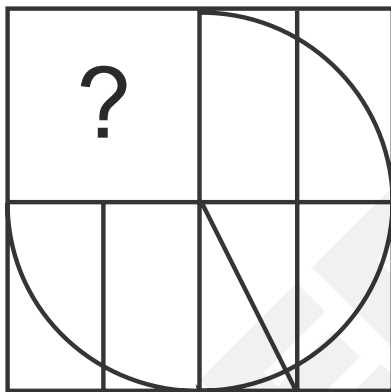

Option 1:

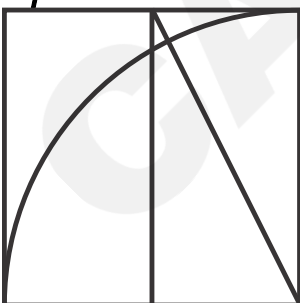

Option 2:

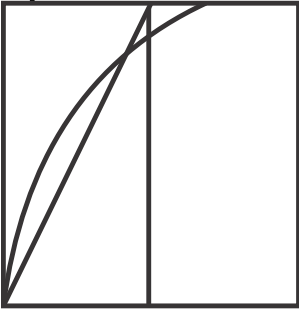

Option 3:

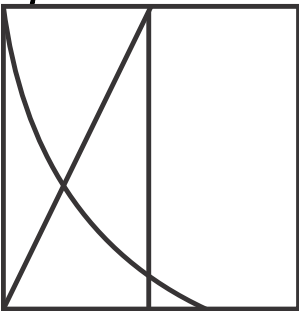

Option 4:

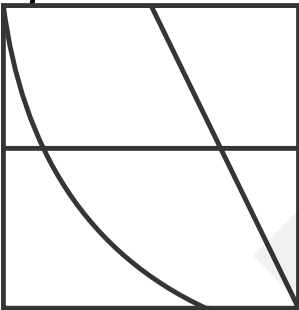

Correct Answer:

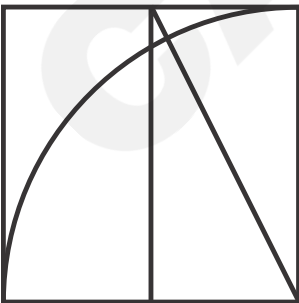

Solution:

On comparing the question figure and all the answer figures, the following figure will combine and make the complete pattern –

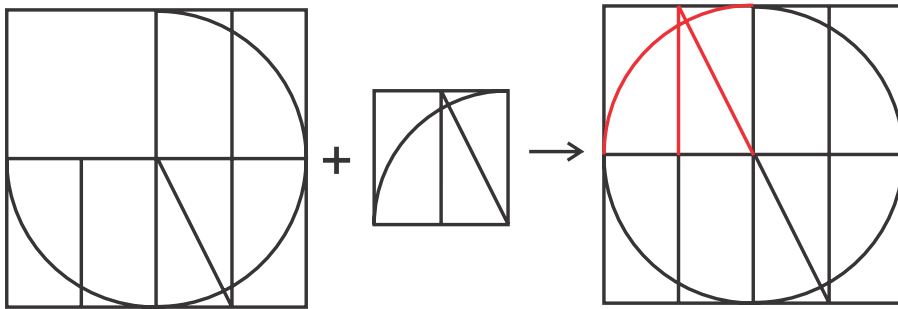

Hence, the **first option** is correct.

Q. 13 **Directions:** Which answer figure will complete the pattern in the question figure?

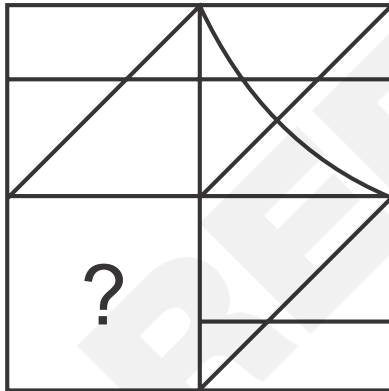

Option 1:

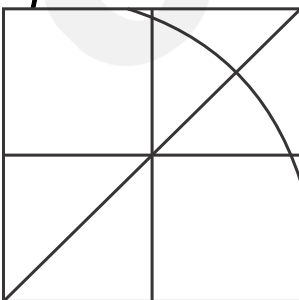

Option 2:

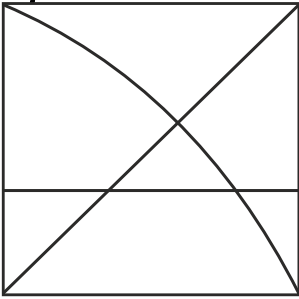

Option 3:

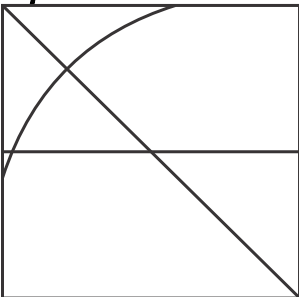

Option 4:

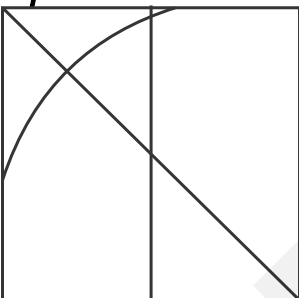

Correct Answer:

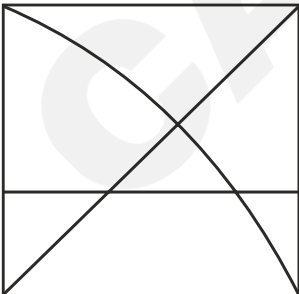

Solution:

On comparing the question figure and all the answer figures, the following figure will combine and make the complete pattern –

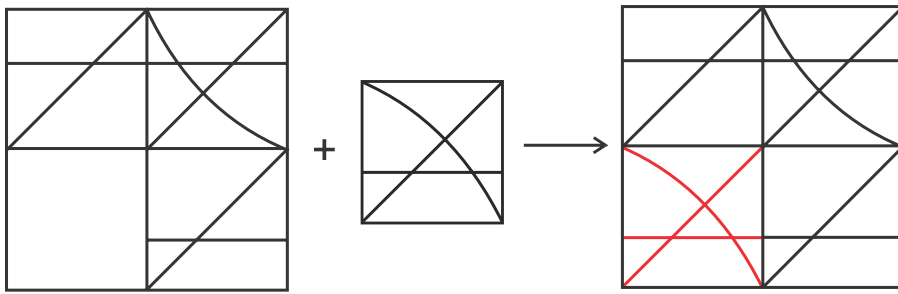

Hence, the **second option** is correct.

Q. 14 **Directions:** Which answer figure will complete the pattern in the question figure?

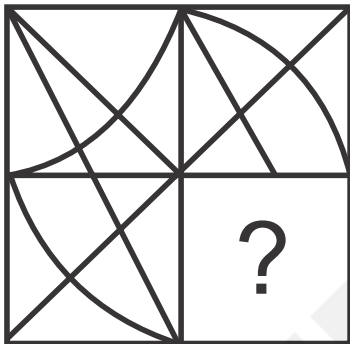

Option 1:

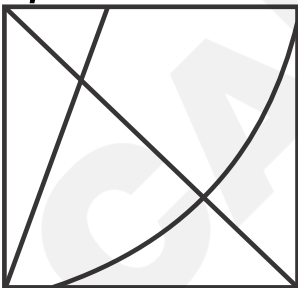

Option 2:

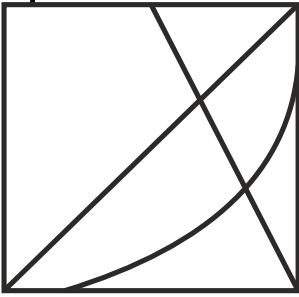

Option 3:

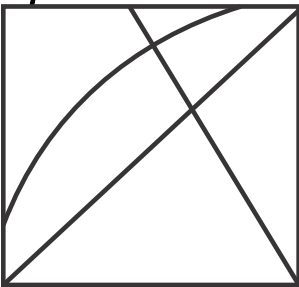

Option 4:

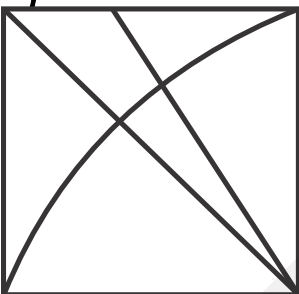

Correct Answer:

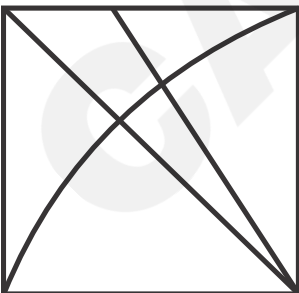

Solution:

On comparing the question figure and all the answer figures, the following figure will combine and make the complete pattern -

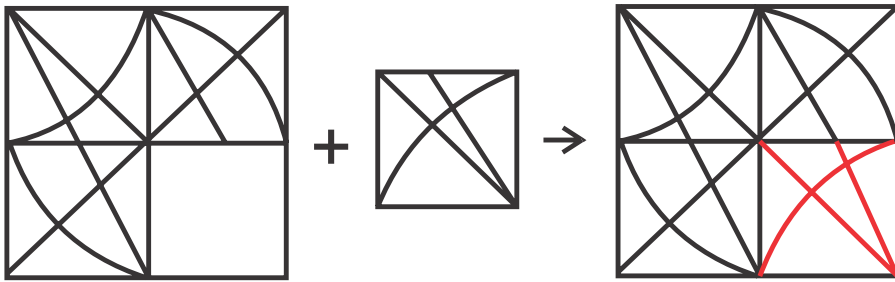

Hence, the **fourth option** is correct.

- Q. 15** **Directions:** Which answer figure will complete the pattern in the question figure?

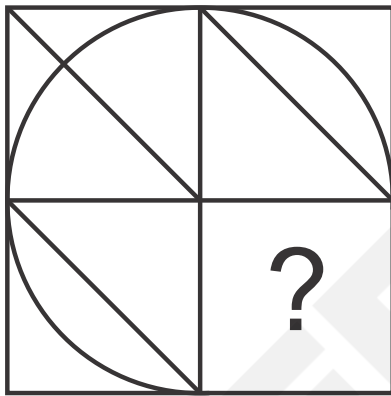

Option 1:

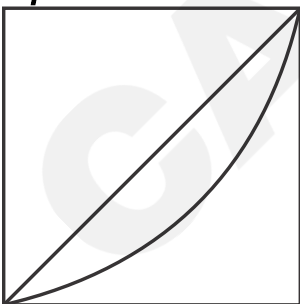

Option 2:

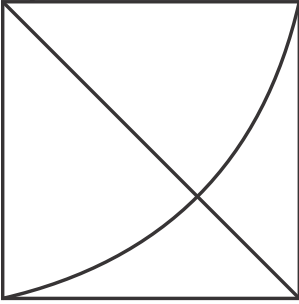

Option 3:

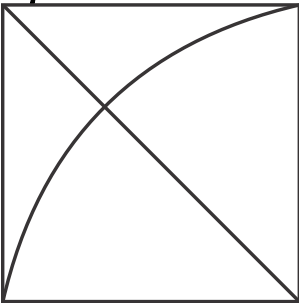

Option 4:

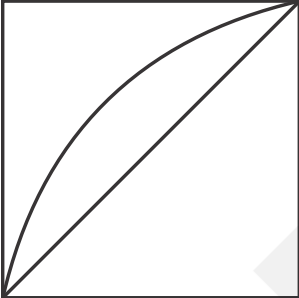

Correct Answer:

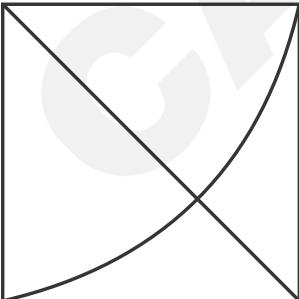

Solution:

On comparing the question figure and all the answer figures, the following figure will combine and make the complete pattern -

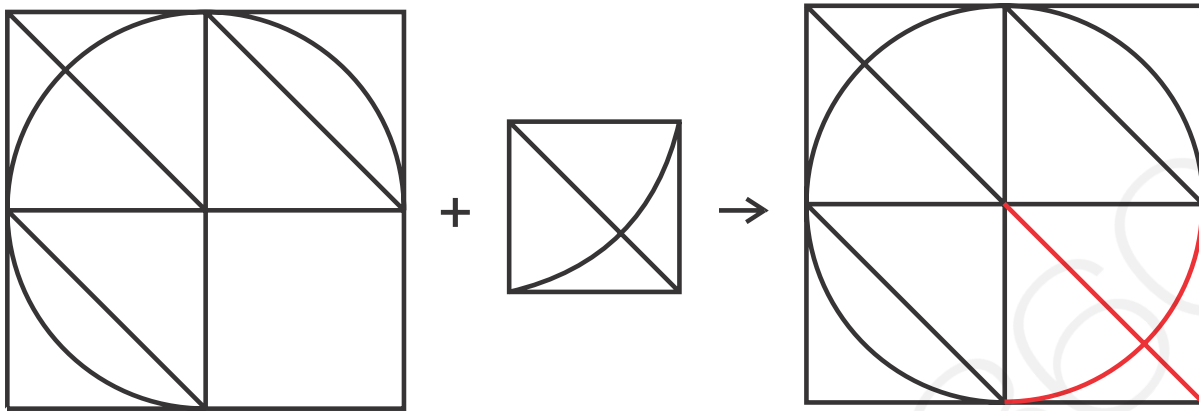

Hence, the **second option** is correct.

Q. 16 **Directions:** Which answer figure will complete the pattern in the question figure?

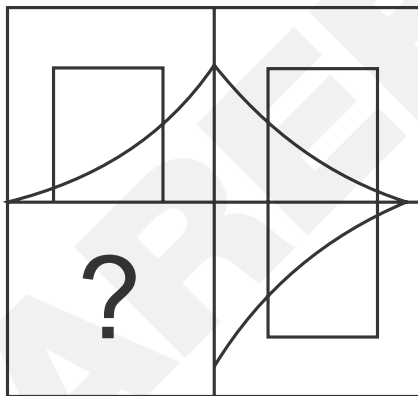

Option 1:

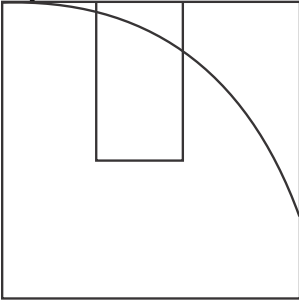

Option 2:

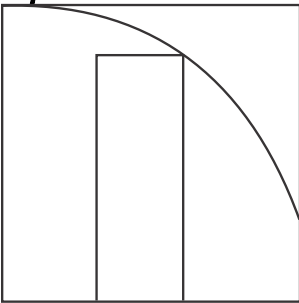

Option 3:

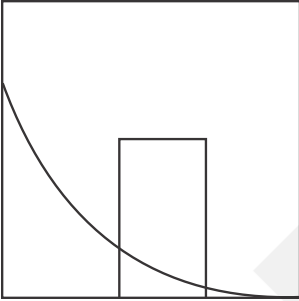

Option 4:

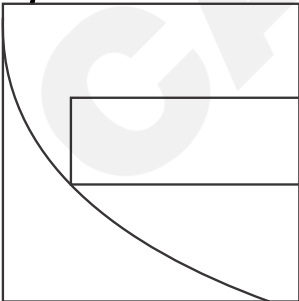

Correct Answer:

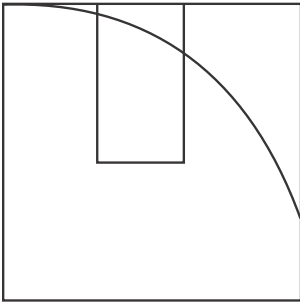

Solution:

On comparing the question figure and all the answer figures, the following figure will combine and make the complete pattern -

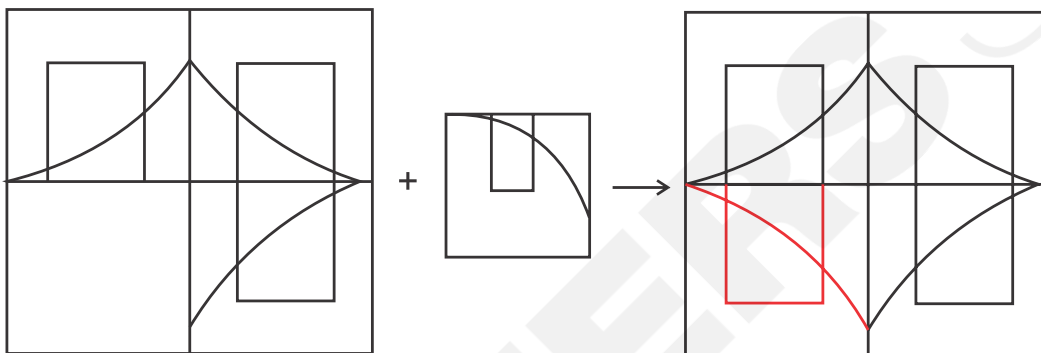

Hence, the **first option** is correct.

Q. 17 **Directions:** Which answer figure will complete the pattern in the question figure?

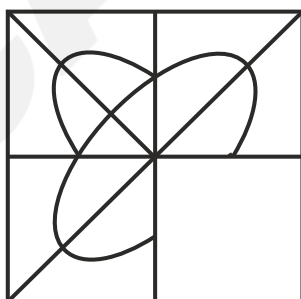

Option 1:

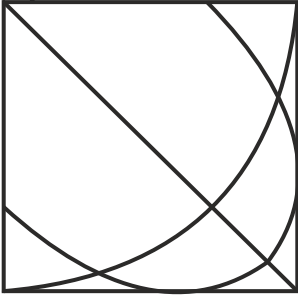

Option 2:

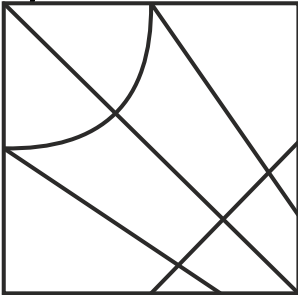

Option 3:

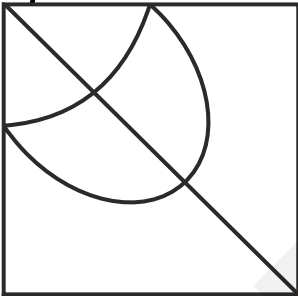

Option 4:

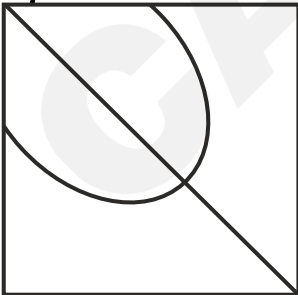

Correct Answer:

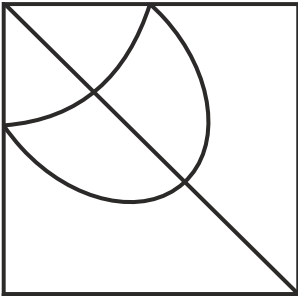

Solution:

On comparing the question figure and all the answer figures, the following figure will combine and make the complete pattern –

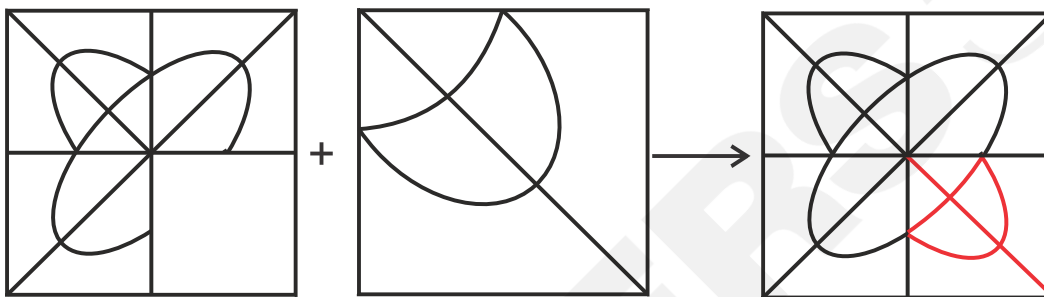

Hence, the **third option** is correct.

Q. 18 **Directions:** Which answer figure will complete the pattern in the question figure?

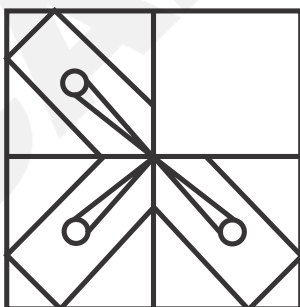

Option 1:

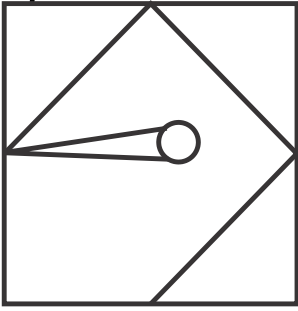

Option 2:

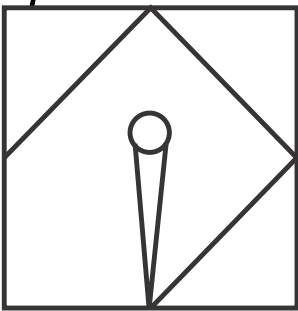

Option 3:

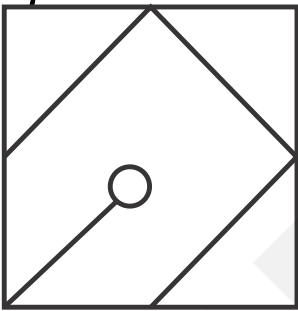

Option 4:

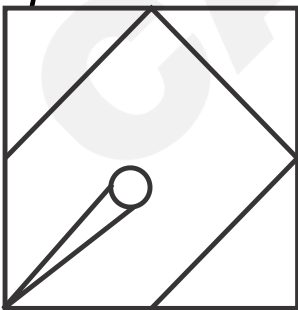

Correct Answer:

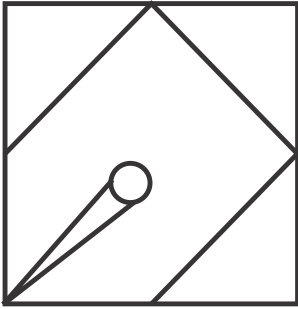

Solution:

On comparing the question figure and all the answer figures, the following figure will combine and make the complete pattern -

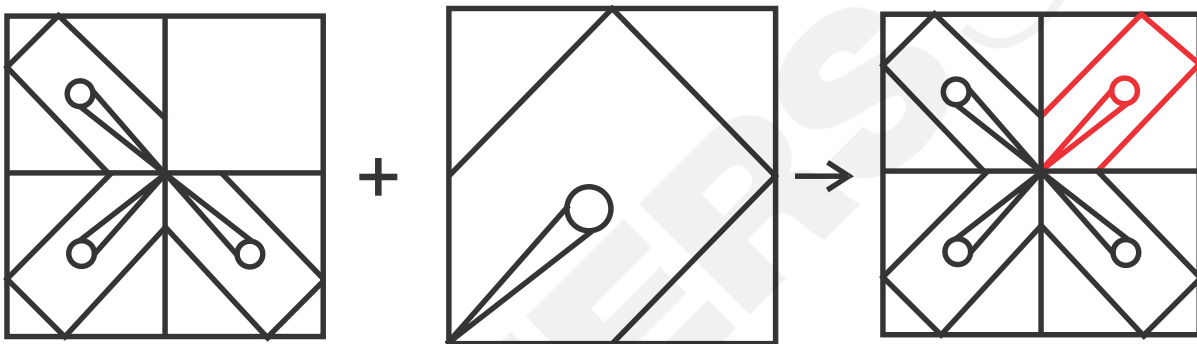

Hence, the **fourth option** is correct.

Q. 19 **Directions:** Which answer figure will complete the pattern in the question figure?

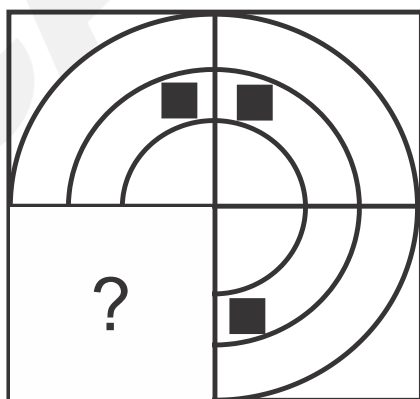

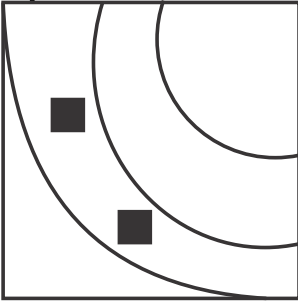
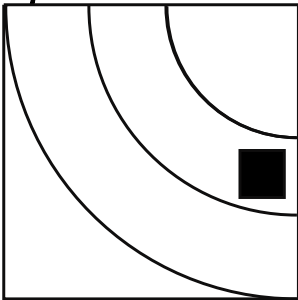
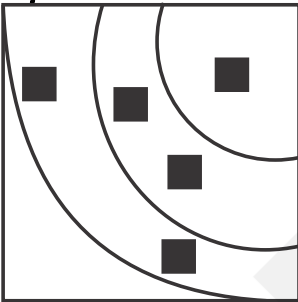
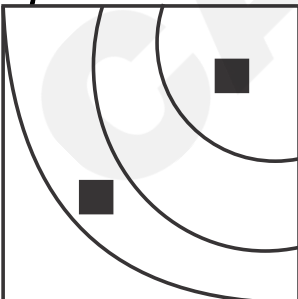
Option 1:**Option 2:****Option 3:****Option 4:**

Correct Answer:

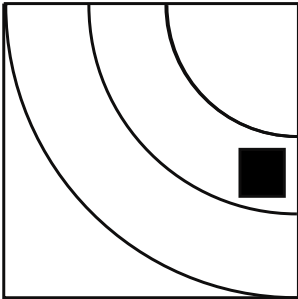

Solution:

On comparing the question figure and all the answer figures, the following figure will combine and make the complete pattern –

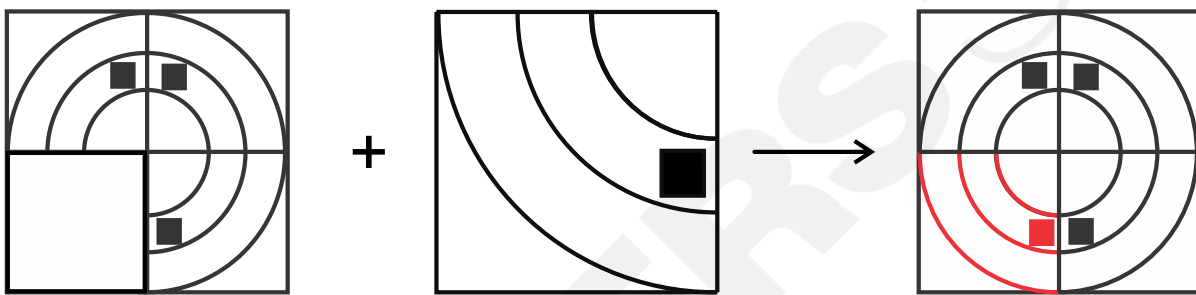

Hence, the **second option** is correct.

Q. 20 **Directions:** Which answer figure will complete the pattern in the question figure?

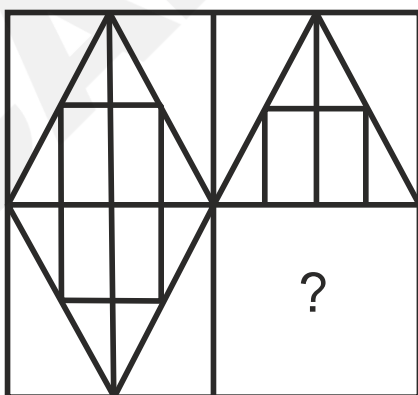

Option 1:

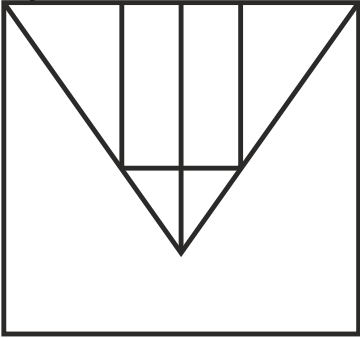

Option 2:

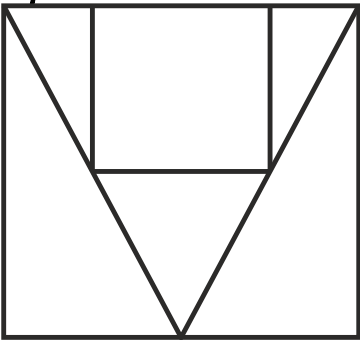

Option 3:

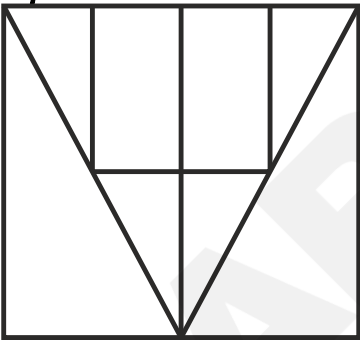

Option 4:

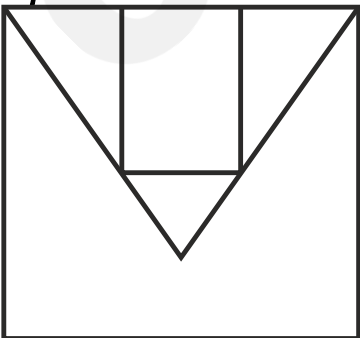

Correct Answer:

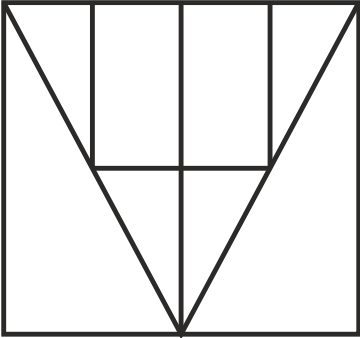

Solution:

The following figure will combine and make the complete pattern –

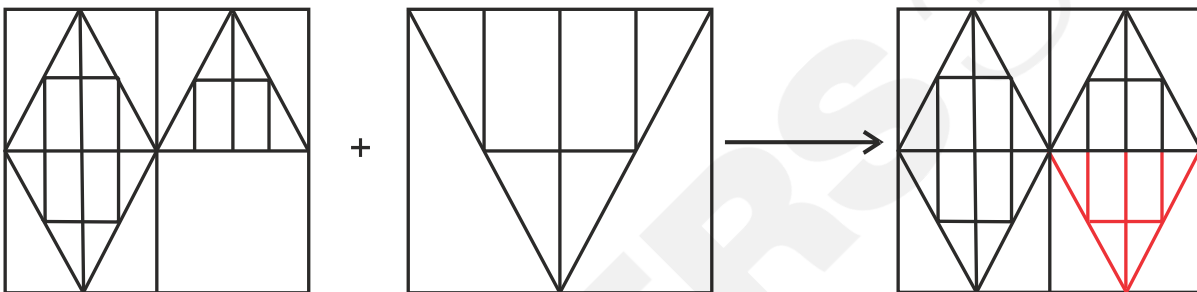

Hence, the **third option** is correct.

Q. 21 **Directions:** Which answer figure will complete the pattern in the question figure?

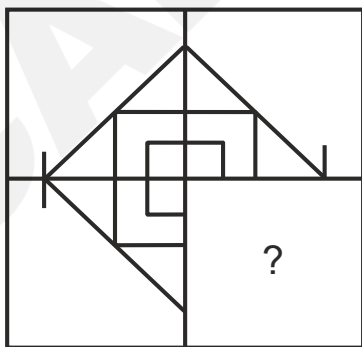

Option 1:

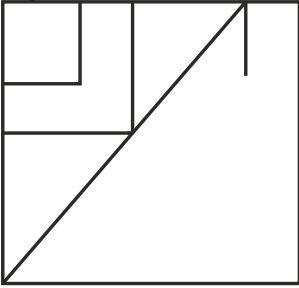

Option 2:

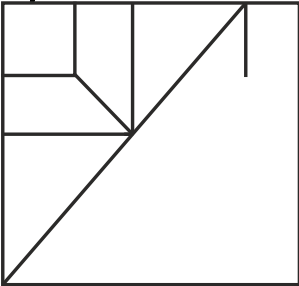

Option 3:

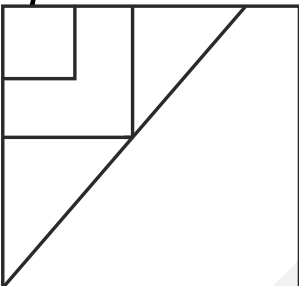

Option 4:

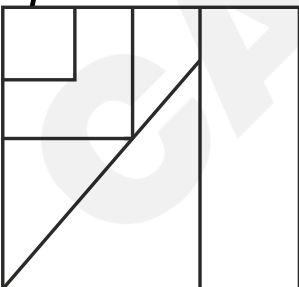

Correct Answer:

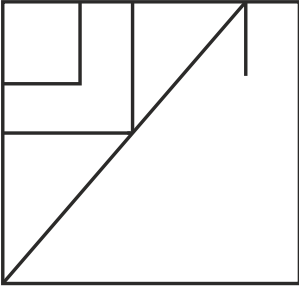

Solution:

On comparing the question figure and all the answer figures, the following figure will combine and make the complete pattern -

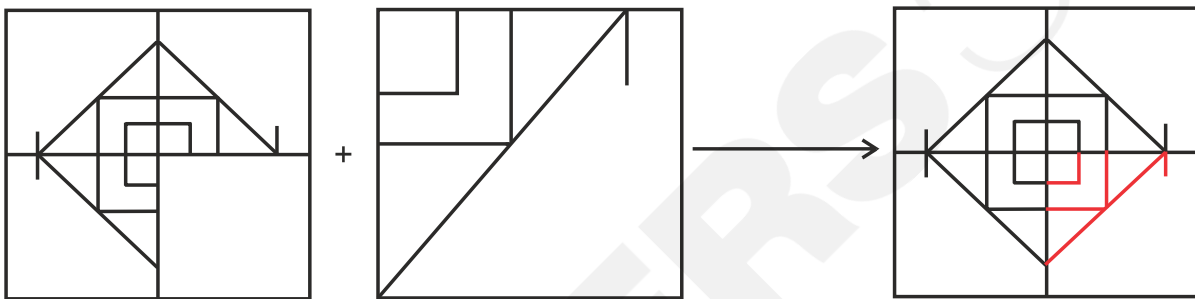

Hence, the **first option** is correct.

Q. 22 **Directions:** Which answer figure will complete the pattern in the question figure?

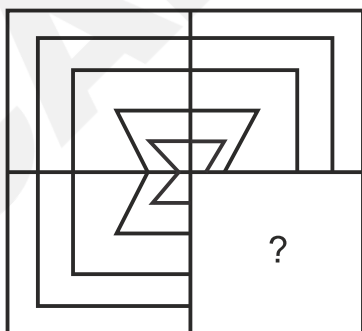

Option 1:

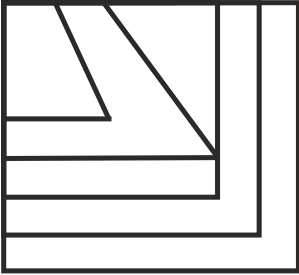

Option 2:

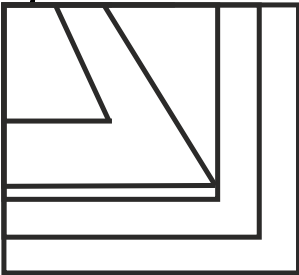

Option 3:

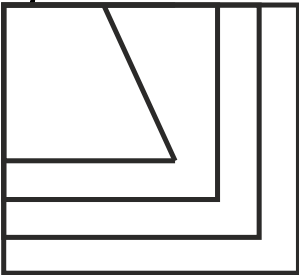

Option 4:

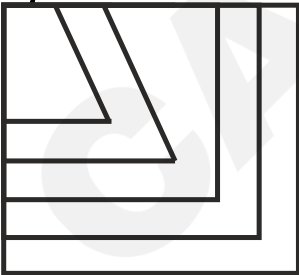

Correct Answer:

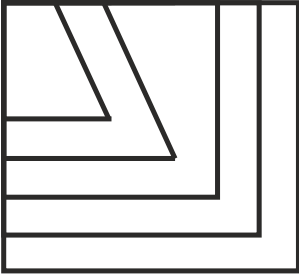

Solution:

On comparing the question figure and all the answer figures, the following figure will combine and make the complete pattern -

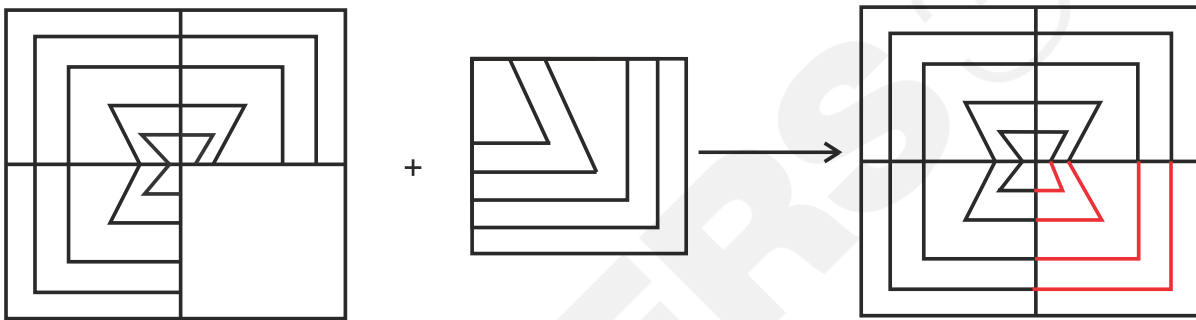

Hence, the **fourth option** is correct.

Q. 23 **Directions:** Which answer figure will complete the pattern in the question figure?

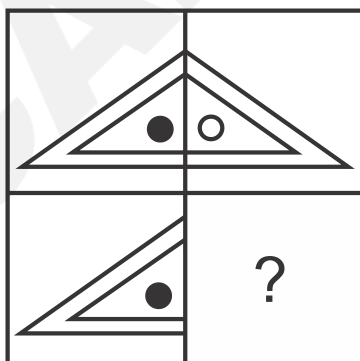

Option 1:

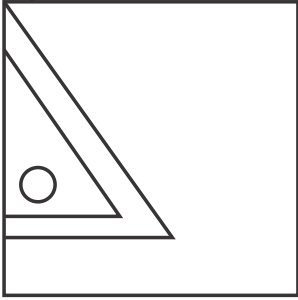

Option 2:

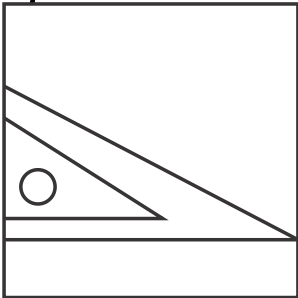

Option 3:

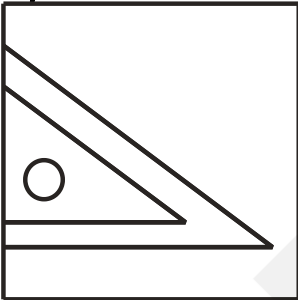

Option 4:

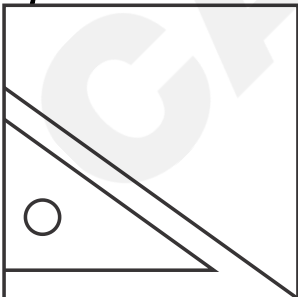

Correct Answer:

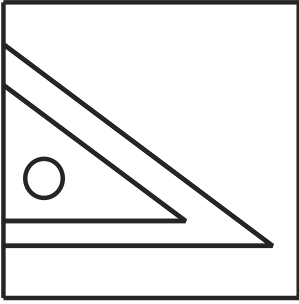

Solution:

On comparing the question figure and all the answer figures, the following figure will combine and make the complete pattern -

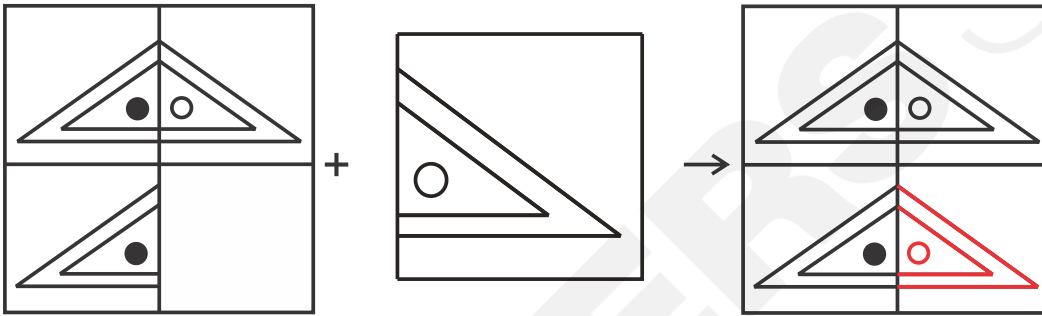

Hence, the **third option** is correct.

Q. 24 **Directions:** Which answer figure will complete the pattern in the question figure?

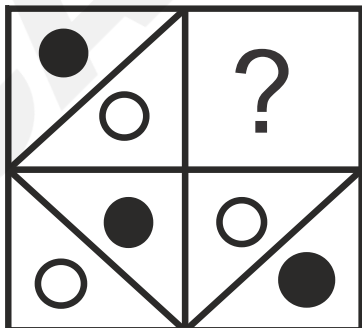

Option 1:

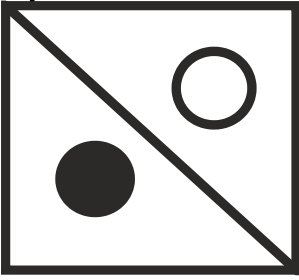

Option 2:

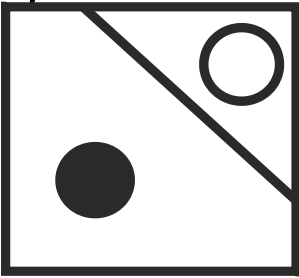

Option 3:

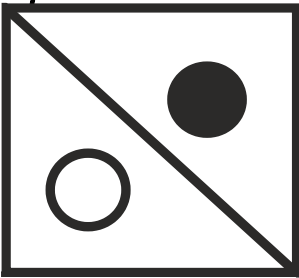

Option 4:

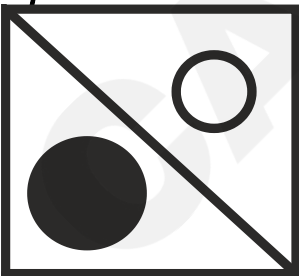

Correct Answer:

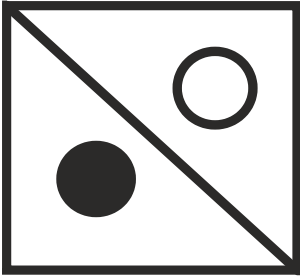

Solution:

The following figures can combine to form a complete pattern –

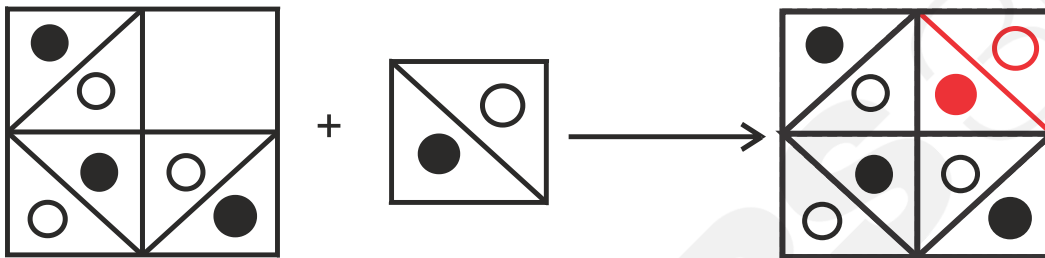

Hence, the **first option** is correct.

Q. 25 **Directions:** Select the figure that will come next in the following figure series.

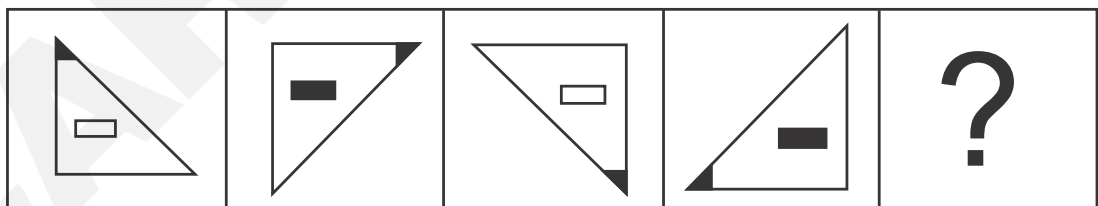

Option 1:

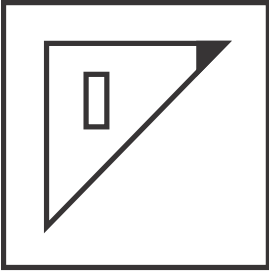

Option 2:

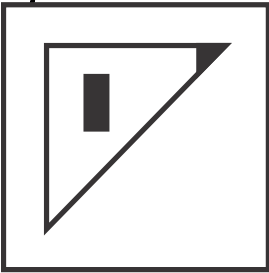

Option 3:

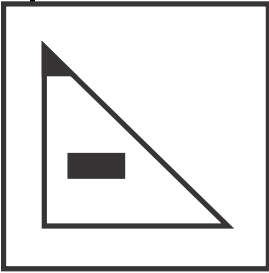

Option 4:



Correct Answer:

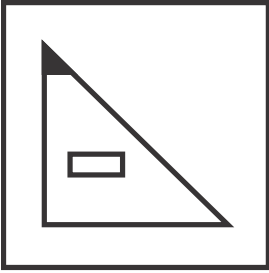

Solution:

According to the question figure –

1. The triangle is rotated by 90° in a clockwise direction.
2. The rectangle symbol inside the triangle is rotated by 90° in a clockwise direction and shaded unshaded alternatively.

So, following the above pattern, the required figure will be as follows

–

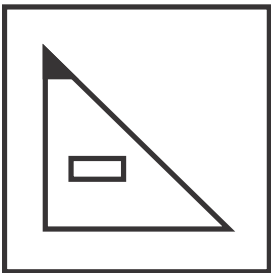

Hence, the **fourth option** is correct.

Q. 26 **Directions:** Which answer figure will complete the pattern in the question figure?

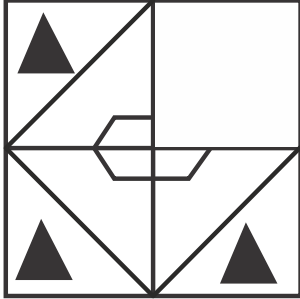

Option 1:

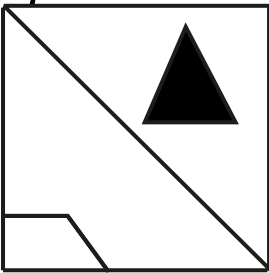

Option 2:



Option 3:

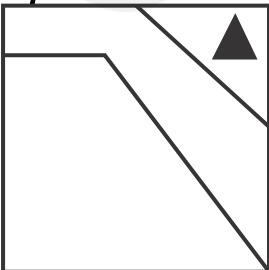

Option 4:

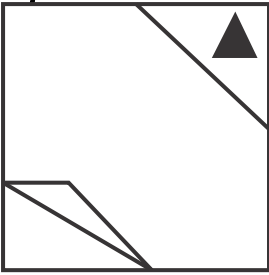

Correct Answer:

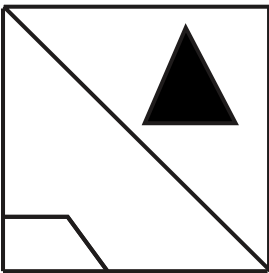

Solution:

On comparing the question figure and all the answer figures, the following figure will combine and make the complete pattern -

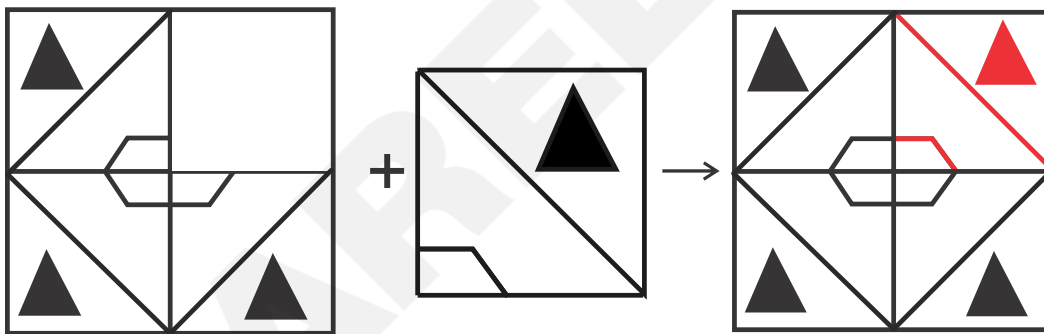

Hence, the **first option** is correct.

Q. 27 **Directions:** Which answer figure will complete the pattern in the question figure?

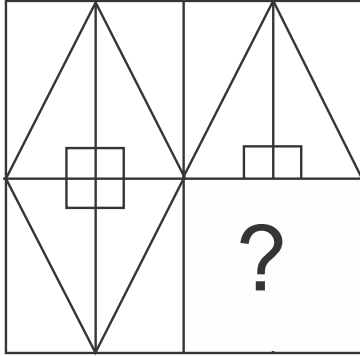

Option 1:

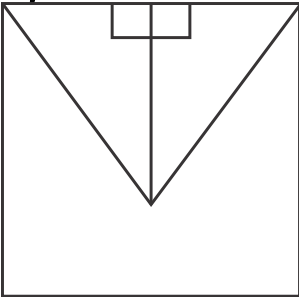

Option 2:

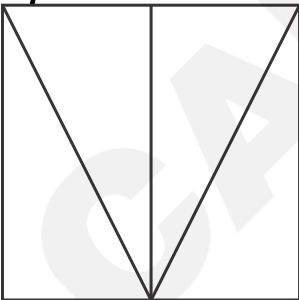

Option 3:

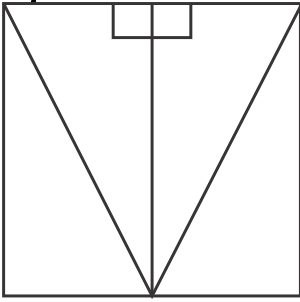

Option 4:

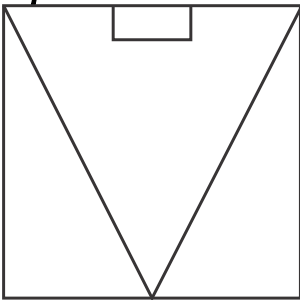

Correct Answer:

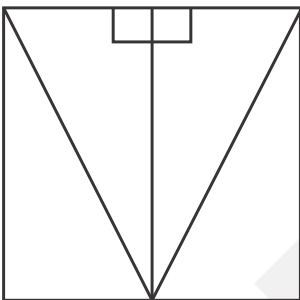

Solution:

On comparing the question figure and all the answer figures, the following figure will combine and make the complete pattern –

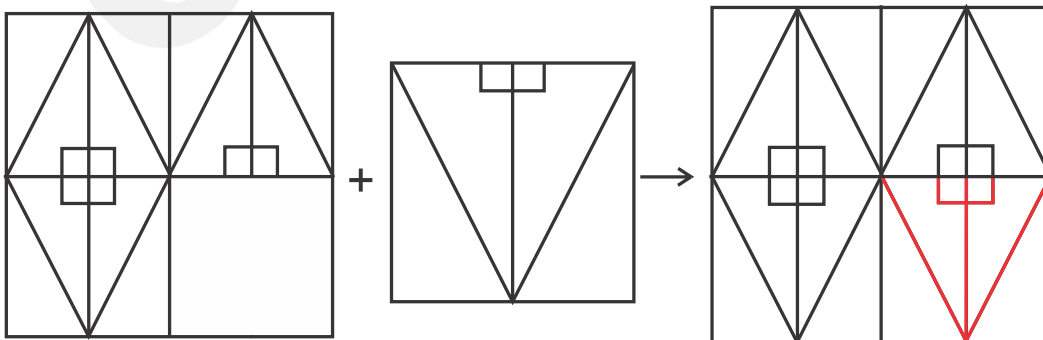

Hence, the **third option** is correct.

- Q. 28** **Directions:** Which answer figure will complete the pattern in the question figure?

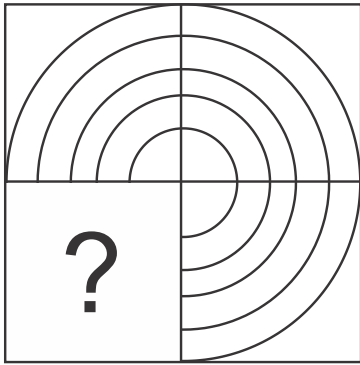

Option 1:

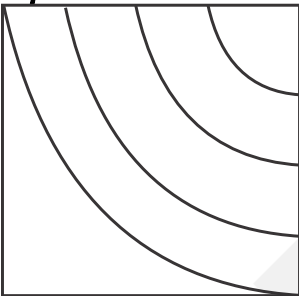

Option 2:

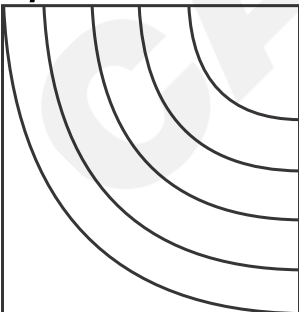

Option 3:

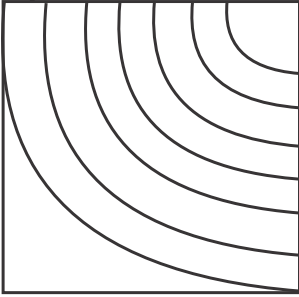

Option 4:

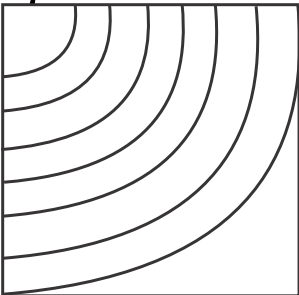

Correct Answer:

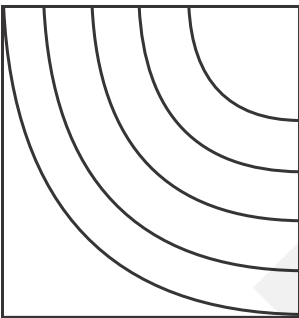

Solution:

On comparing the question figure and all the answer figures, the following figure will combine and make the complete pattern -

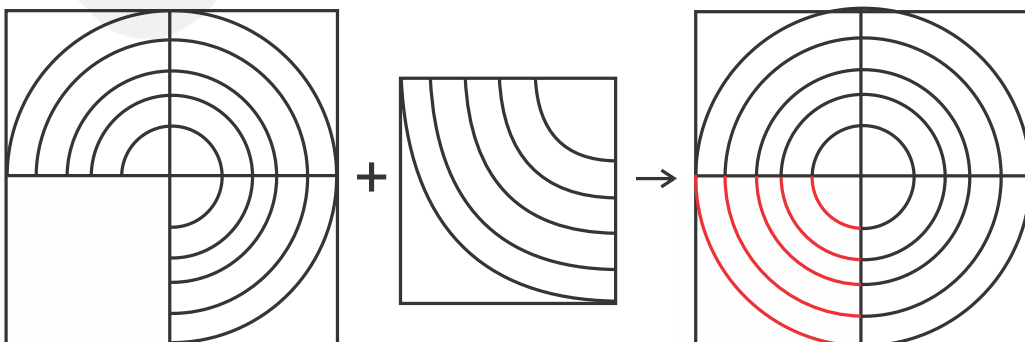

Hence, the **second option** is correct.

- Q. 29** **Directions:** Which answer figure will combine the pattern in the question figure?

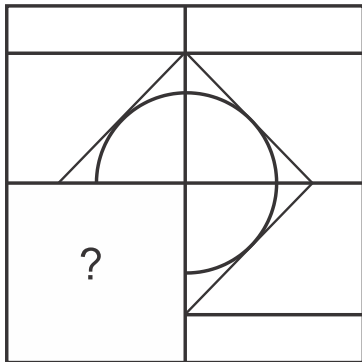

Option 1:

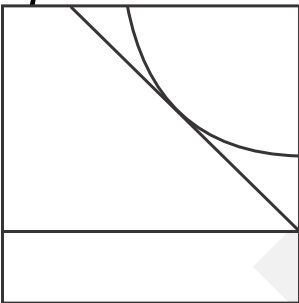

Option 2:

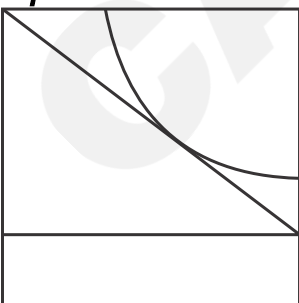

Option 3:

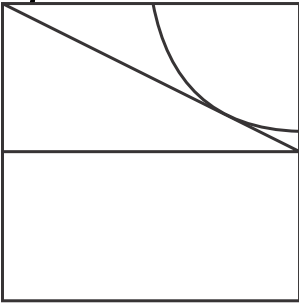

Option 4:

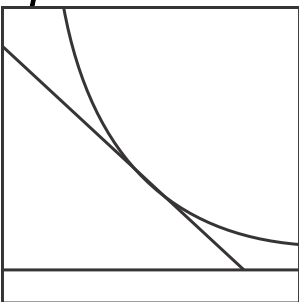

Correct Answer:

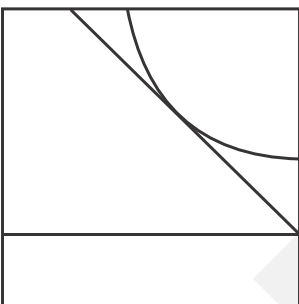

Solution:

On comparing the question figure and all the answer figures, the following figure will combine and make the complete pattern -

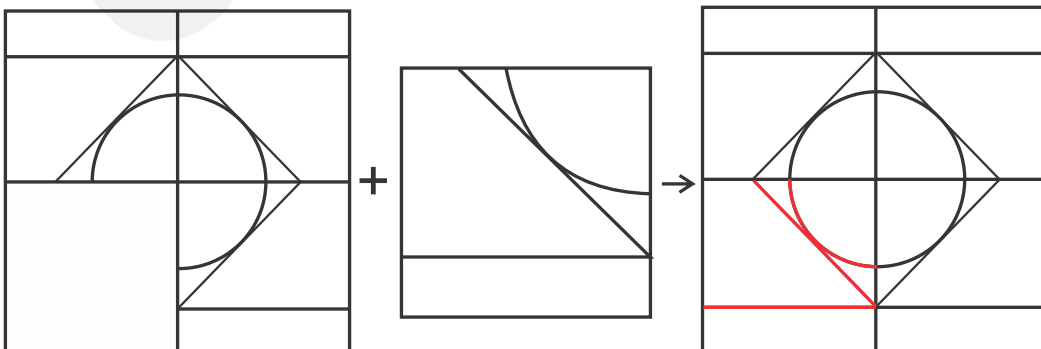

Hence, the **first option** is correct.

- Q. 30** **Directions:** Which answer figure will complete the pattern in the question figure?

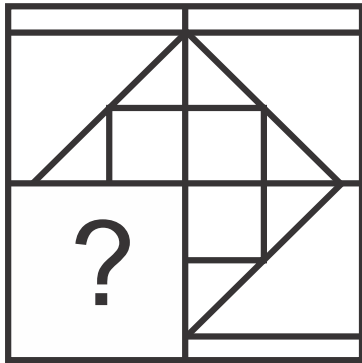

Option 1:

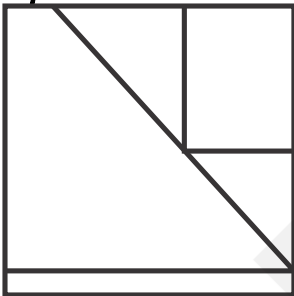

Option 2:

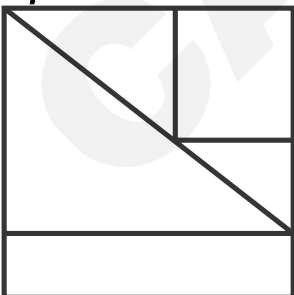

Option 3:

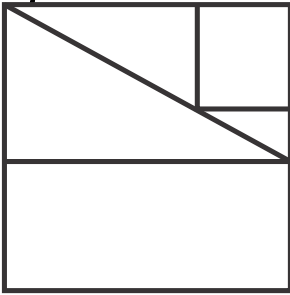

Option 4:

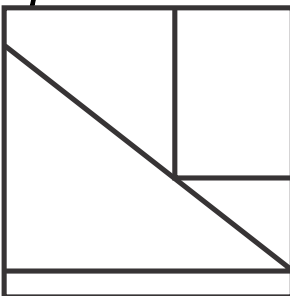

Correct Answer:

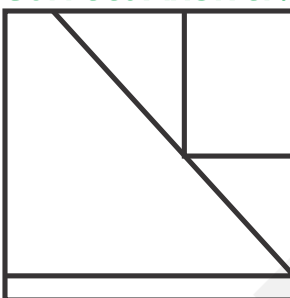

Solution:

On comparing, the question figure and all the answer figures, the following figure will combine and make the complete pattern -

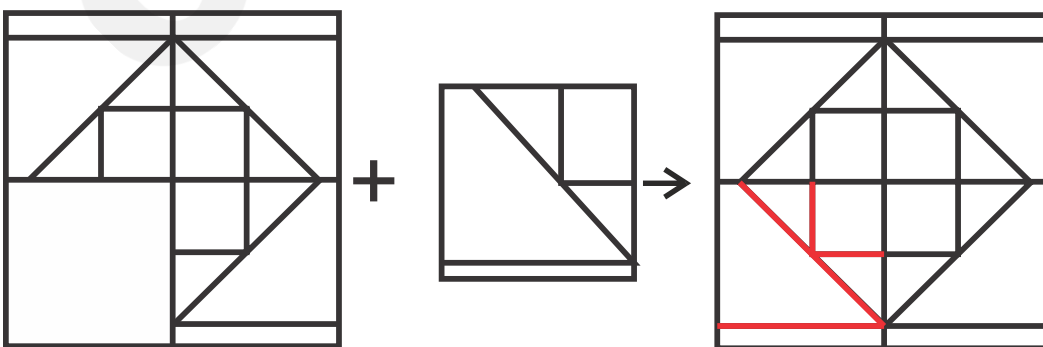

Hence, the **first option** is correct.

- Q. 31** **Directions:** Which answer figure will complete the pattern in the question figure?

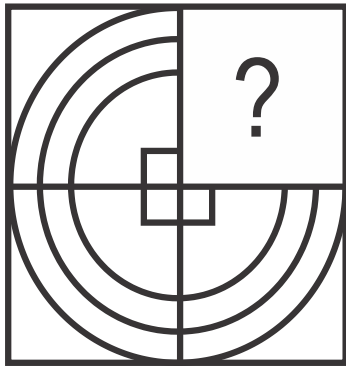

Option 1:



Option 2:

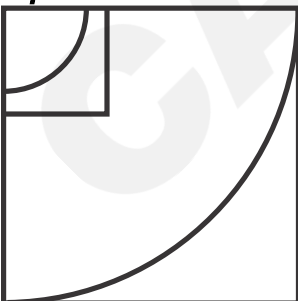

Option 3:

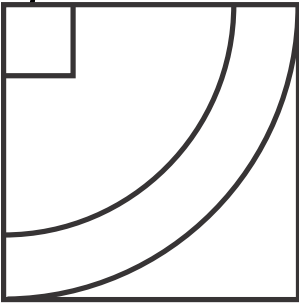

Option 4:

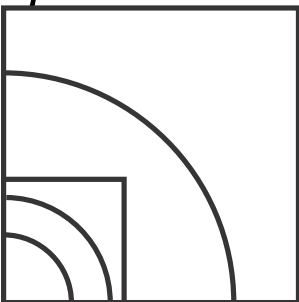

Correct Answer:



Solution:

On comparing the question figure and all the answer figures, the following figure will combine and make the complete pattern -

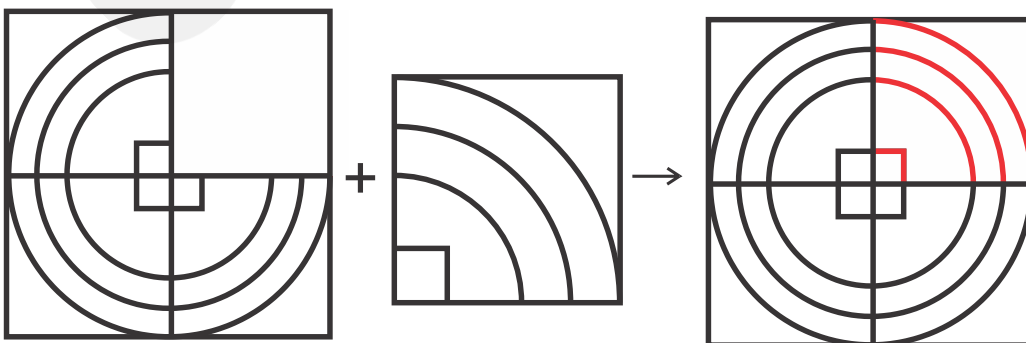

Hence, the **first option** is correct.

- Q. 32** **Directions:** Which answer figure will complete the pattern in the question figure?

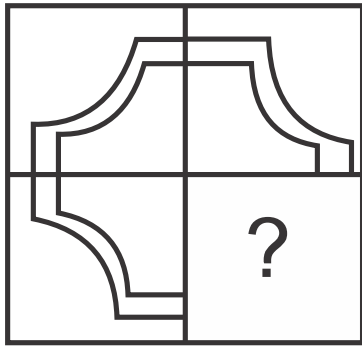

Option 1:

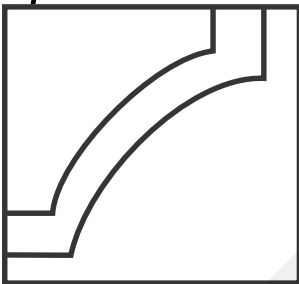

Option 2:

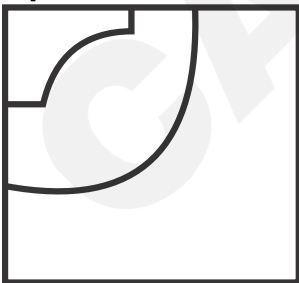

Option 3:

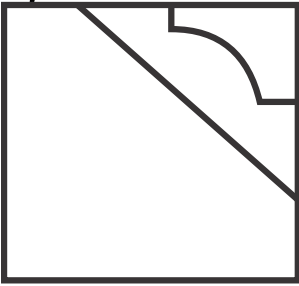

Option 4:



Correct Answer:

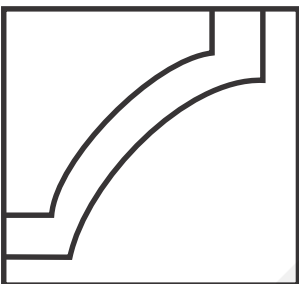

Solution:

On comparing the question figure and all the answer figures, the following figure will combine and make the complete pattern -

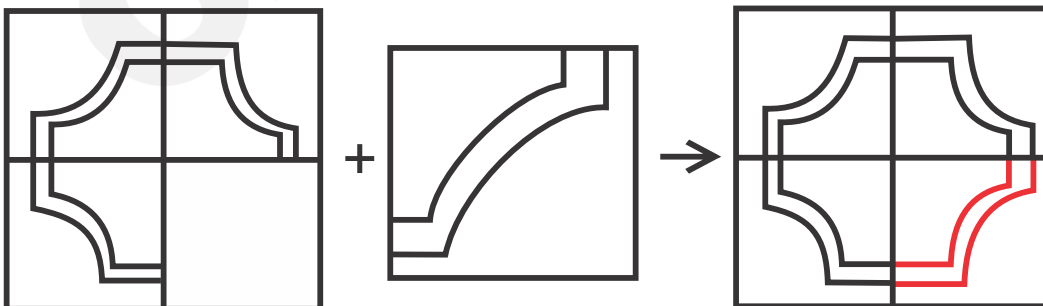

Hence, the **first option** is correct.

- Q. 33** **Directions:** Which answer figure will complete the pattern in the question figure?

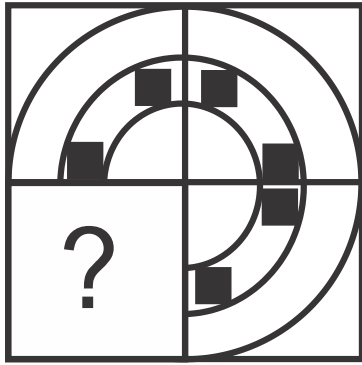

Option 1:

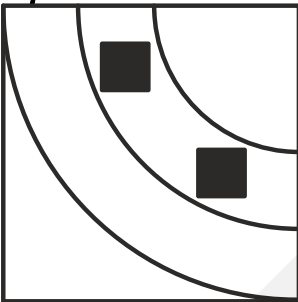

Option 2:



Option 3:

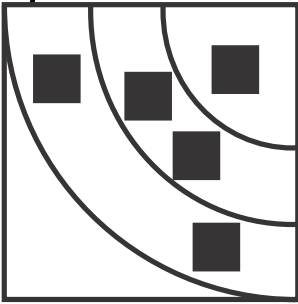

Option 4:

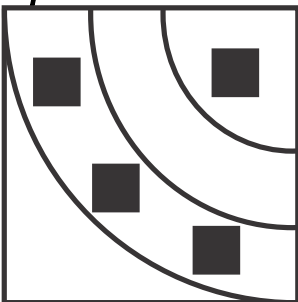

Correct Answer:

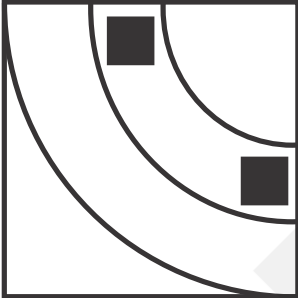

Solution:

On comparing, the question figure and all the answer figures, the following figure will combine and make the complete pattern -

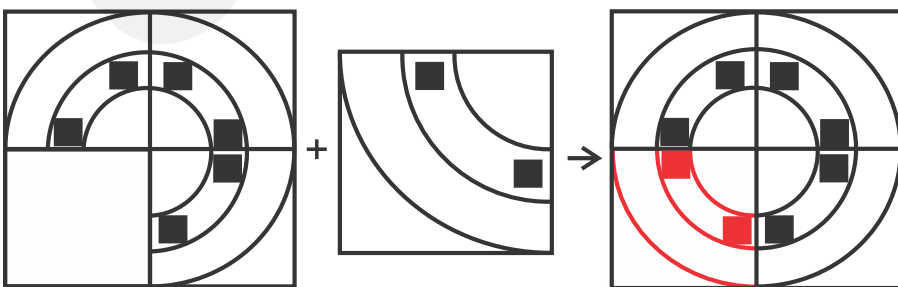

Hence, the **second option** is correct.

- Q. 34** **Directions:** Which answer figure will complete the pattern in the question figure?

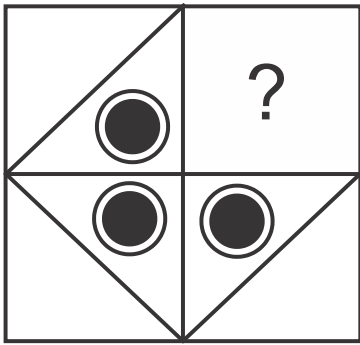

Option 1:

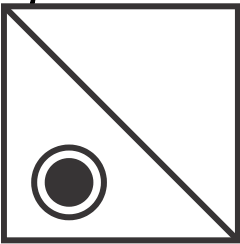

Option 2:

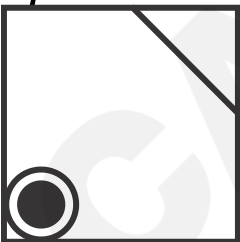

Option 3:

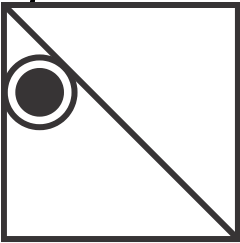

Option 4:

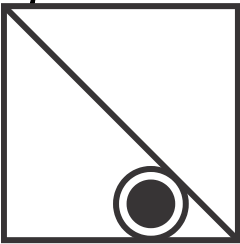

Correct Answer:

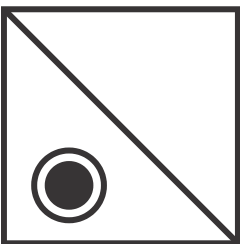

Solution:

On comparing the question figure and all the answer figures, the following figure will combine and make the complete pattern -

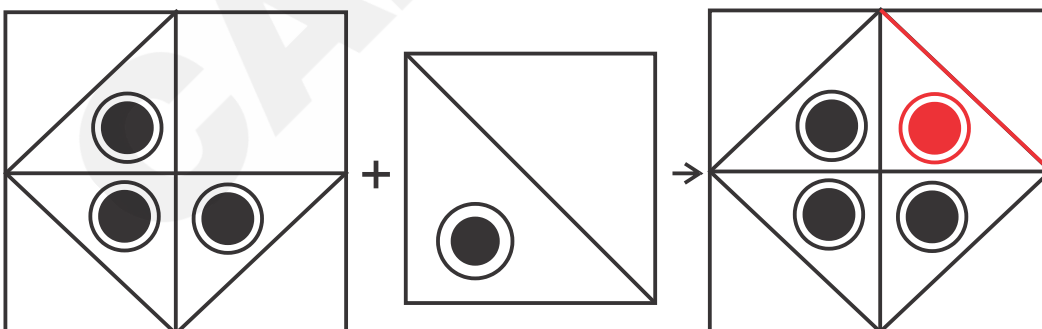

Hence, the **first option** is correct.

Q. 35 **Directions:** Which answer figure will complete the pattern in the question figure?

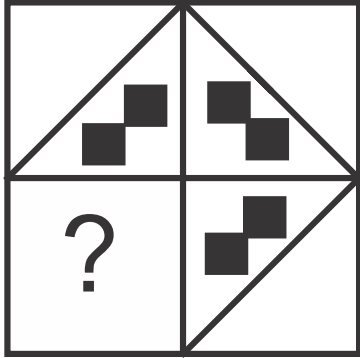

Option 1:

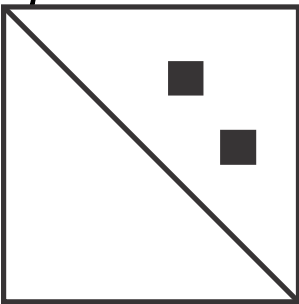

Option 2:

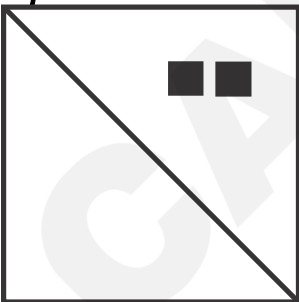

Option 3:

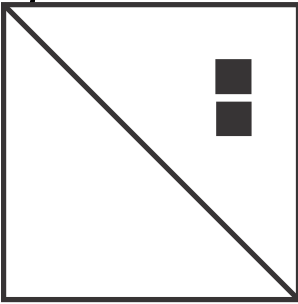

Option 4:

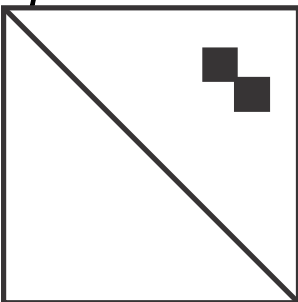

Correct Answer:

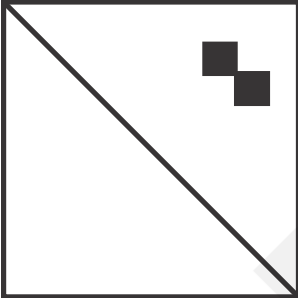

Solution:

On comparing the question figure and all the answer figures, the following figure will combine and make the complete pattern -

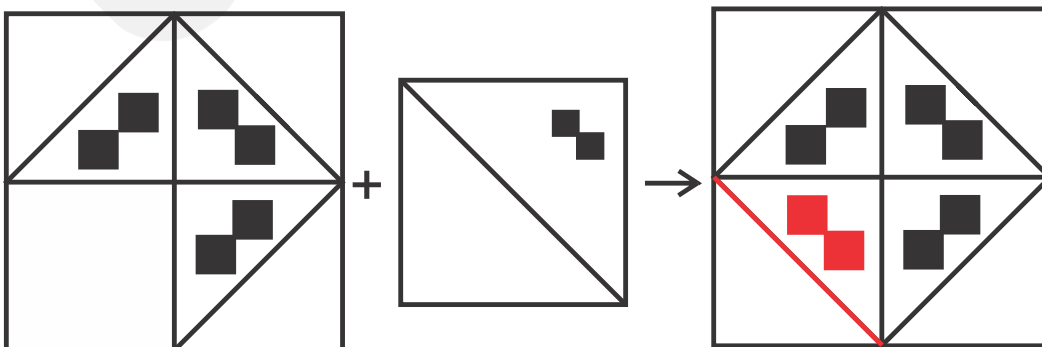

Hence, the **fourth option** is correct.

- Q. 36** **Directions:** Which answer figure will complete the pattern in the question figure?

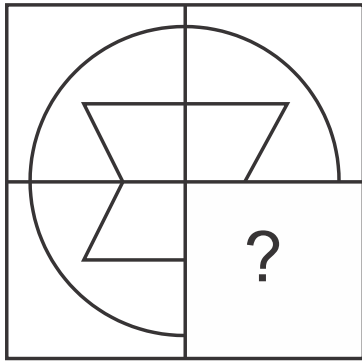

Option 1:

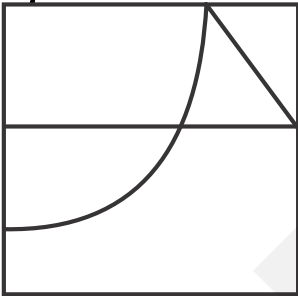

Option 2:

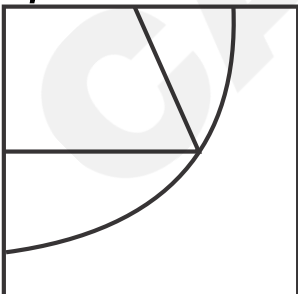

Option 3:

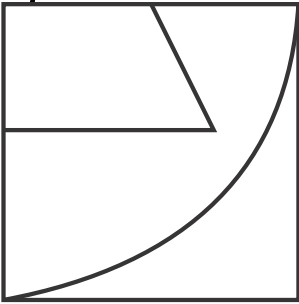

Option 4:

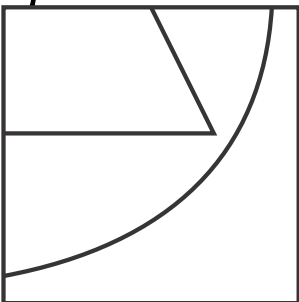

Correct Answer:



Solution:

On comparing the question figure and all the answer figures, the following figure will combine and make the complete pattern -

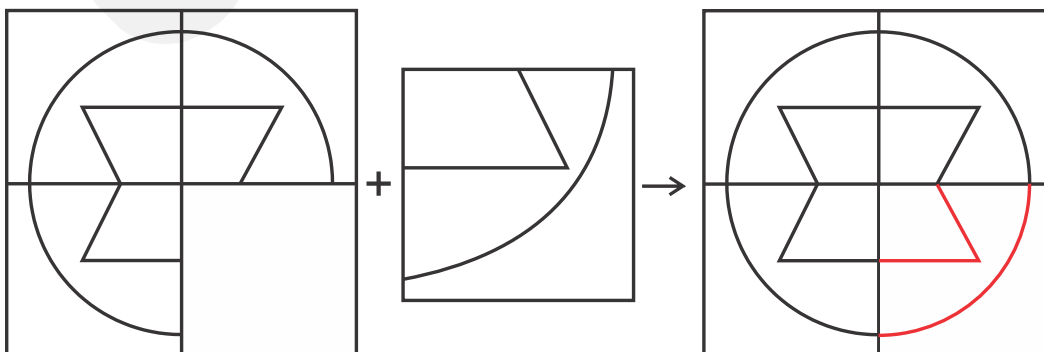

Hence, the **fourth option** is correct.

- Q. 37** **Directions:** Among the four answer figures, which one can be formed from the cut-out pieces given below in the question figure?

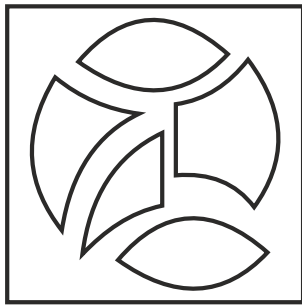

Option 1:

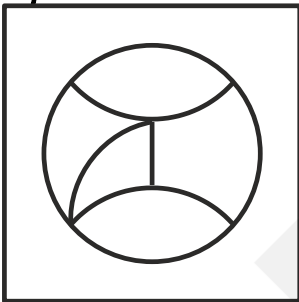

Option 2:

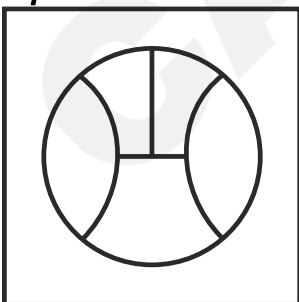

Option 3:

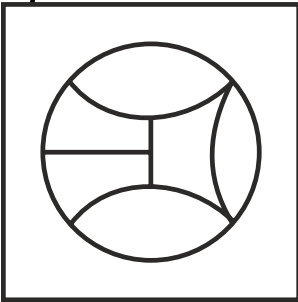

Option 4:

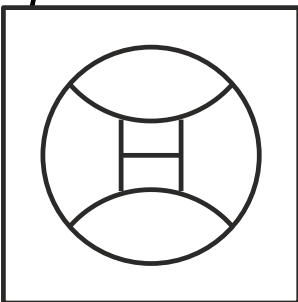

Correct Answer:

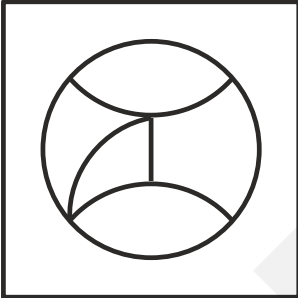

Solution:

The various parts of the figure can be numbered as follows –

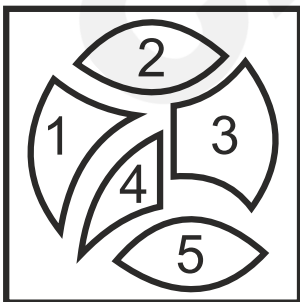

The parts can be arranged in the following manner –

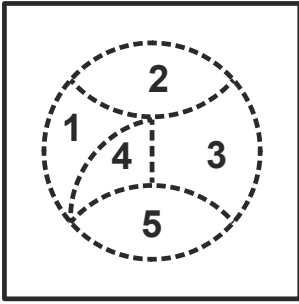

The above-compiled figure matches the figure given in the first option. Hence, the **first option** is correct.

- Q. 38** **Directions:** Identify the answer figure from which the pieces given in the question figure have been cut.

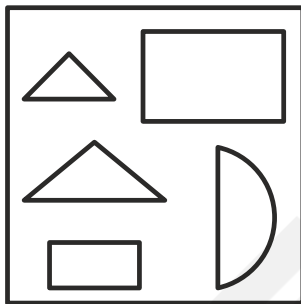

Option 1:

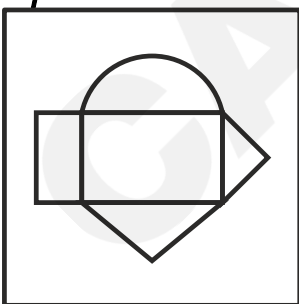

Option 2:

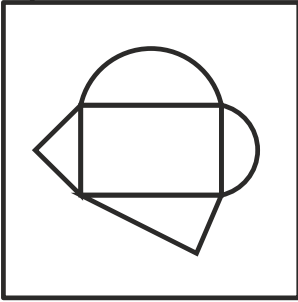

Option 3:

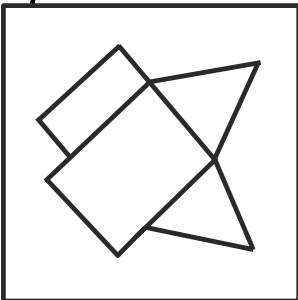

Option 4:

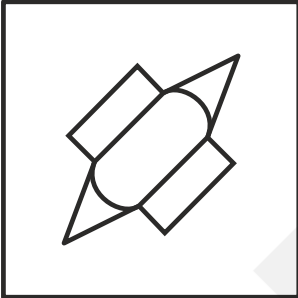

Correct Answer:

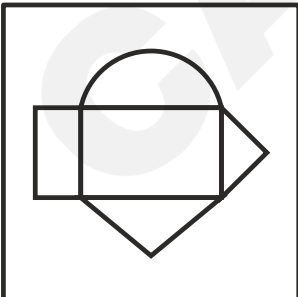

Solution:

The given parts of the figure can be labelled as follows –

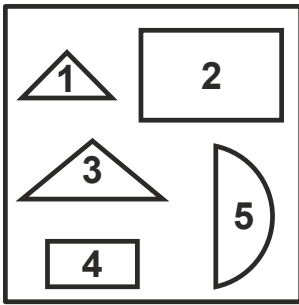

The parts can be arranged in the following manner –

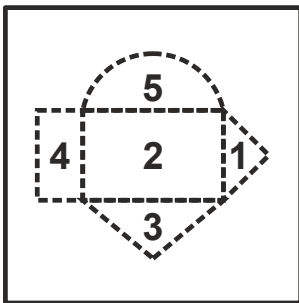

The above-compiled figure matches the figure given in the first option. Hence, the **first option** is correct.

- Q. 39** **Directions:** Among the four answer figures, which one can be formed from the cut-out pieces given below in the question figure?

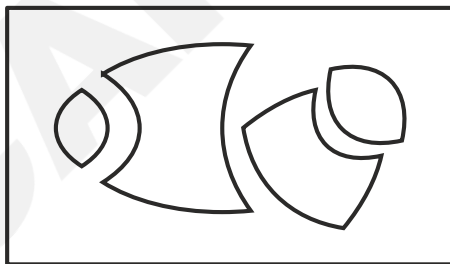

Option 1:

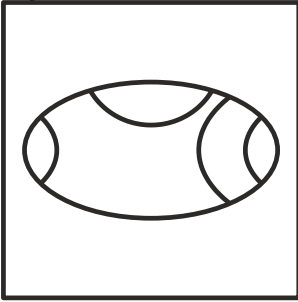

Option 2:

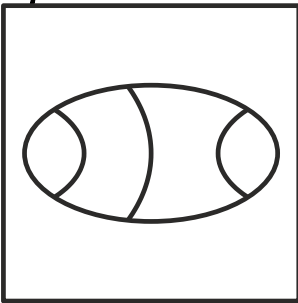

Option 3:

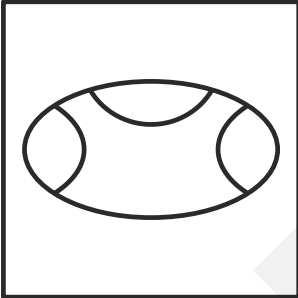

Option 4:

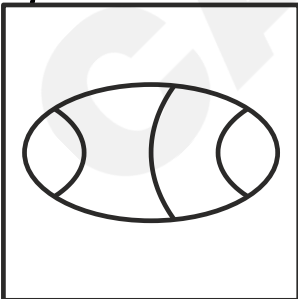

Correct Answer:

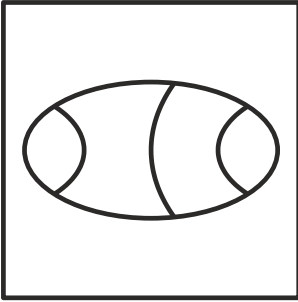

Solution:

The various parts of the figure can be numbered as follows –

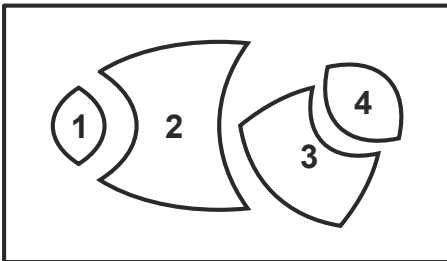

The parts can be arranged in the following manner –

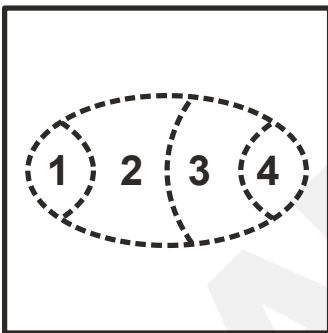

The above-compiled figure matches the figure given in the fourth option. Hence, the **fourth option** is correct.

- Q. 40** **Directions:** From the answer figures, select the one that can be formed from the components given in the question figure.

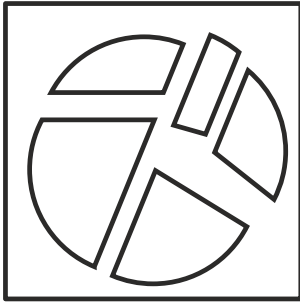

Option 1:

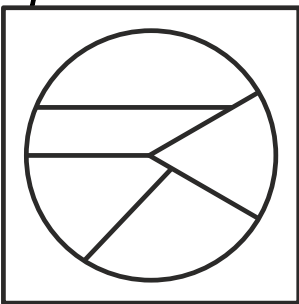

Option 2:

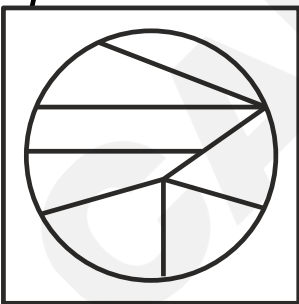

Option 3:

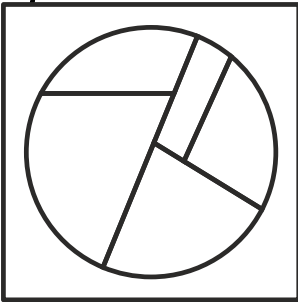

Option 4:

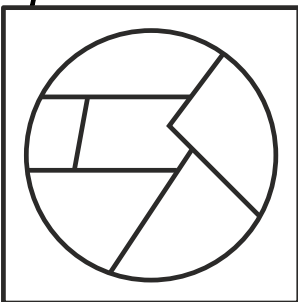

Correct Answer:

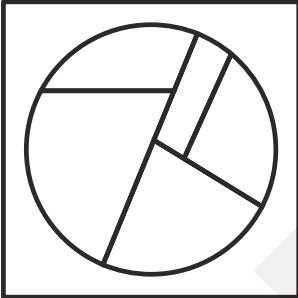

Solution:

The various parts of the figure can be numbered as follows –

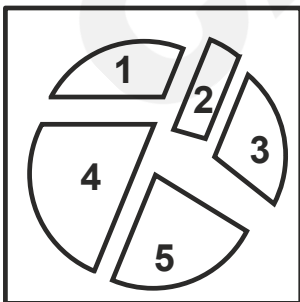

The parts can be arranged in the following manner –

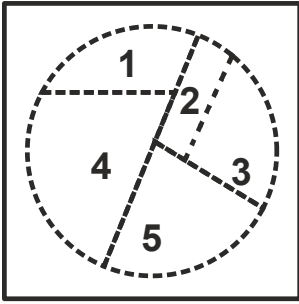

The above-compiled figure matches the figure given in the third option. Hence, the **third option** is correct.

- Q. 41** **Directions:** Among the four answer figures, which one can be formed from the cut-out pieces given below in the question figure?

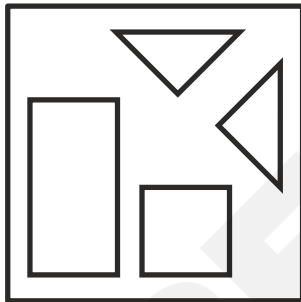

Option 1:

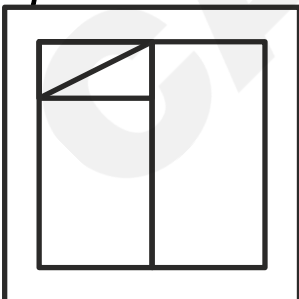

Option 2:

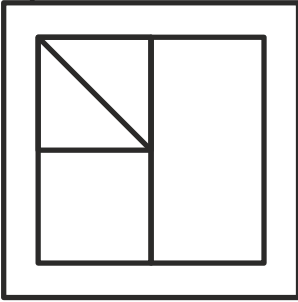

Option 3:

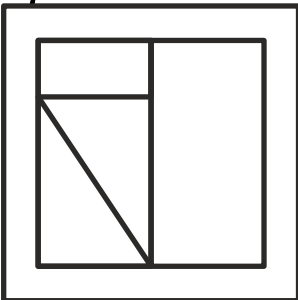

Option 4:

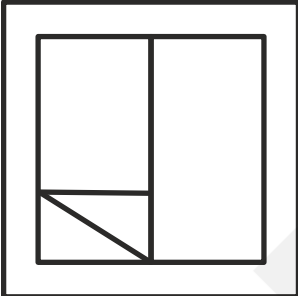

Correct Answer:

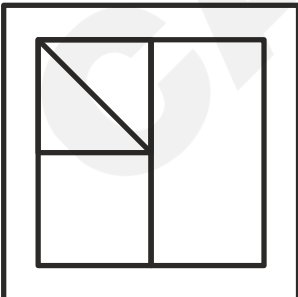

Solution:

The various parts of the figure can be numbered as follows –

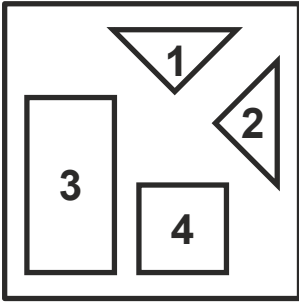

The parts can be arranged in the following manner –

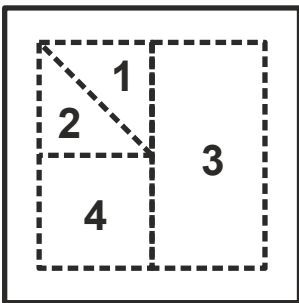

The above-compiled figure matches the figure given in the second option. Hence, the **second option** is correct.

- Q. 42** **Directions:** Among the four answer figures, which one can be formed from the cutout pieces given below in the question figure?

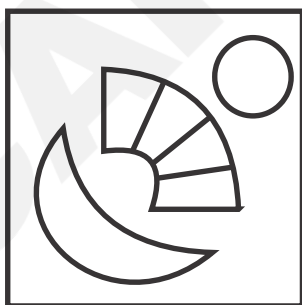

Option 1:

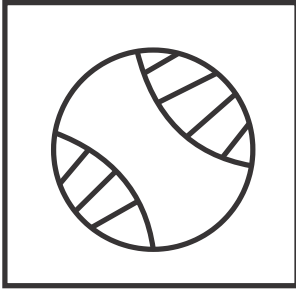

Option 2:

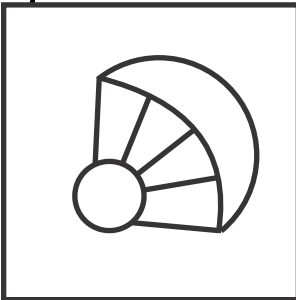

Option 3:

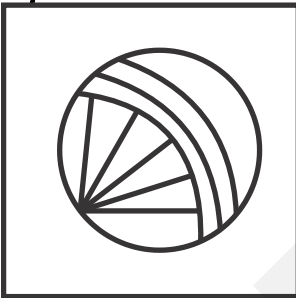

Option 4:

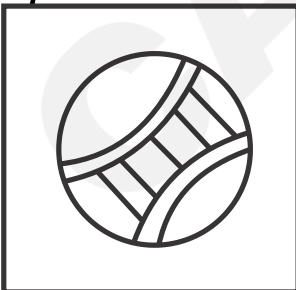

Correct Answer:

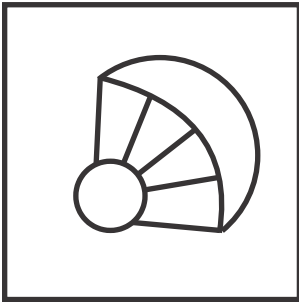

Solution:

The given figure can be numbered as shown below –

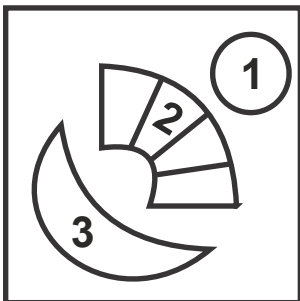

The parts can be arranged in the following manner –

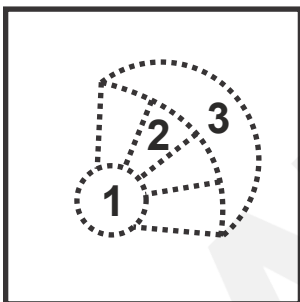

The above-compiled figure matches the figure given in the second option. Hence, the **second option** is correct.

- Q. 43** **Directions:** Identify the answer figure from which the pieces given in the question figure have been cut.

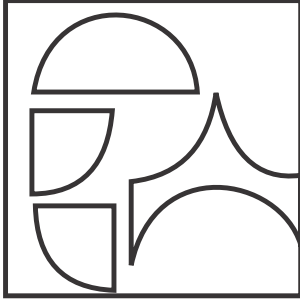

Option 1:

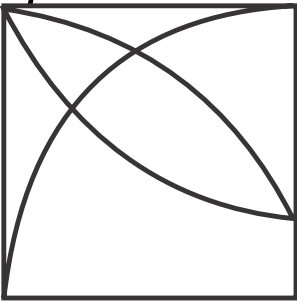

Option 2:

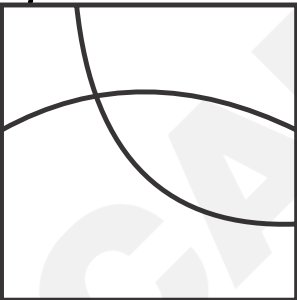

Option 3:

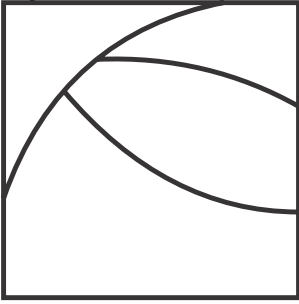

Option 4:

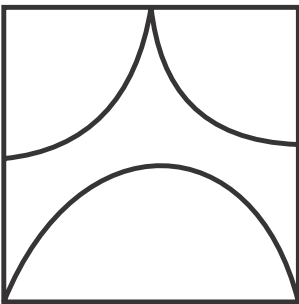

Correct Answer:

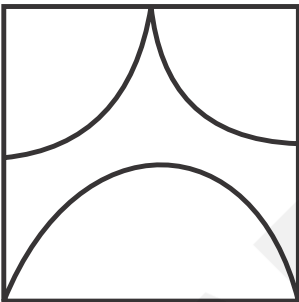

Solution:

The various parts of the figure can be numbered as follows –

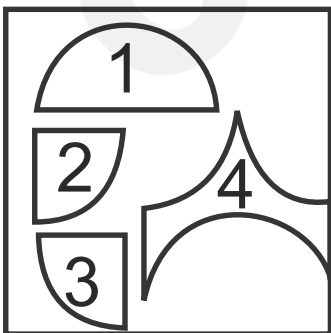

The parts can be arranged in the following manner –

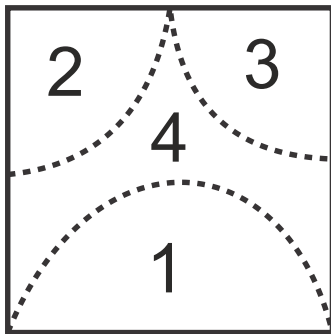

The above-compiled figure matches the figure given in the fourth option. Hence, the **fourth option** is correct.

- Q. 44** **Directions:** Identify the answer figure from which the pieces given in the question figure have been cut.

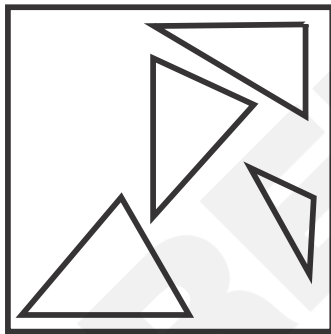

Option 1:

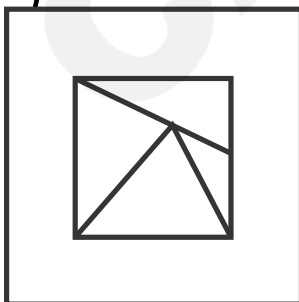

Option 2:

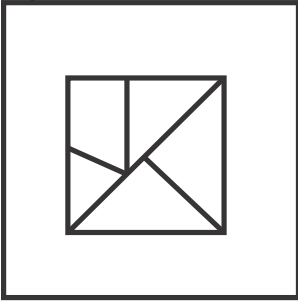

Option 3:

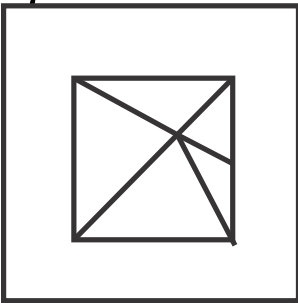

Option 4:

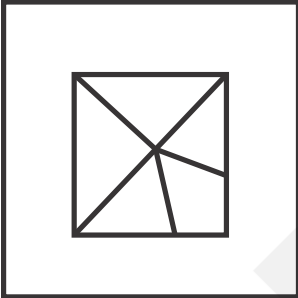

Correct Answer:

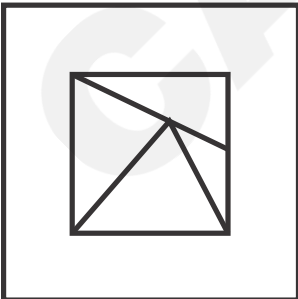

Solution:

The various parts of the figure can be numbered as follows –

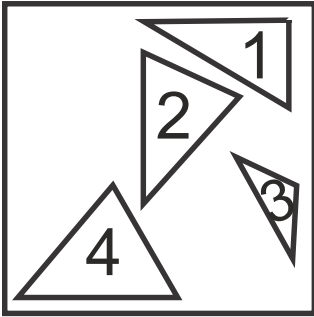

The parts can be arranged in the following manner –

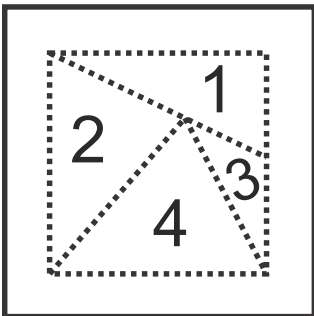

The above-compiled figure matches the figure given in the first option. Hence, the **first option** is correct.

- Q. 45** **Directions:** Identify the answer figure from which the pieces given in the question figure have been cut.

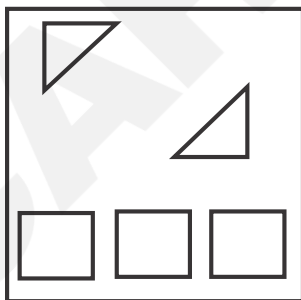

Option 1:

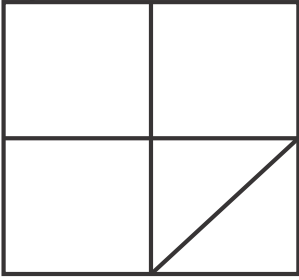

Option 2:

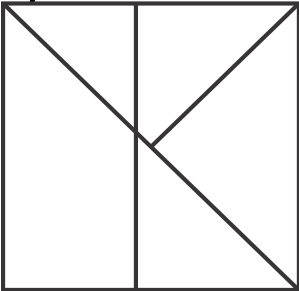

Option 3:

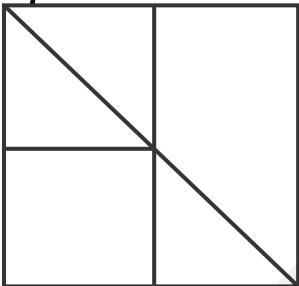

Option 4:

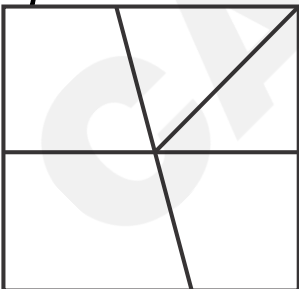

Correct Answer:

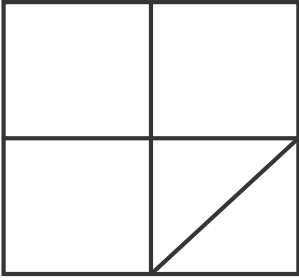

Solution:

The various parts of the figure can be numbered as follows –

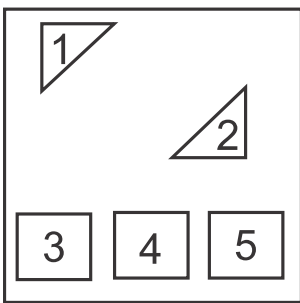

The parts can be arranged in the following manner –

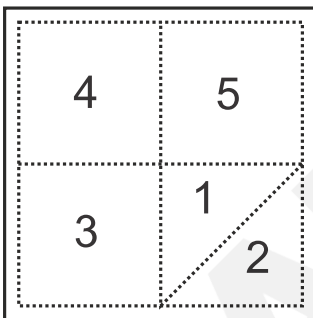

The above-compiled figure matches the figure given in the first option. Hence, the **first option** is correct.

- Q. 46** **Directions:** Identify the answer figure from which the pieces given in the question figure have been cut.

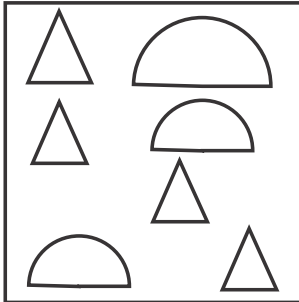

Option 1:

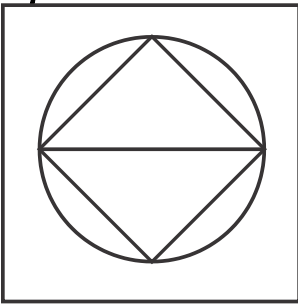

Option 2:

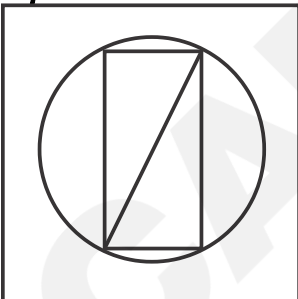

Option 3:

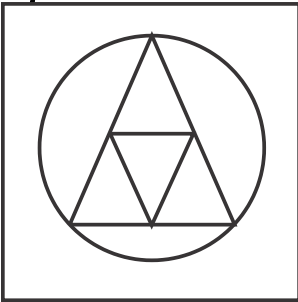

Option 4:

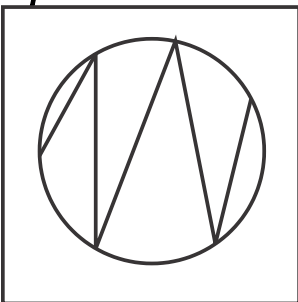

Correct Answer:

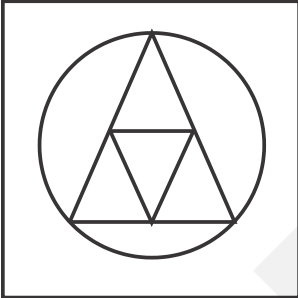

Solution:

The various parts of the figure can be numbered as follows –

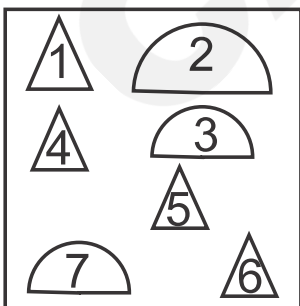

The parts can be arranged in the following manner –

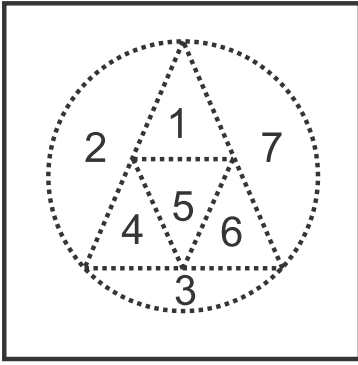

The above-compiled figure matches the figure given in the third option. Hence, the **third option** is correct.

Q. 47 **Directions:** Select the appropriate answer figure from which the question figure is formed.

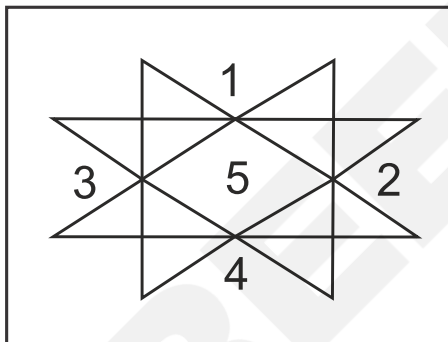

Option 1:

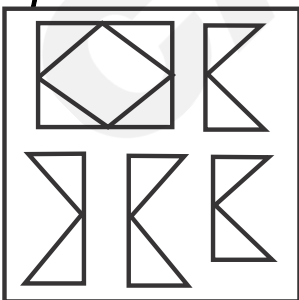

Option 2:

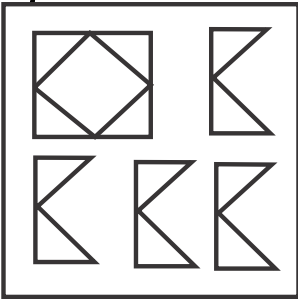

Option 3:

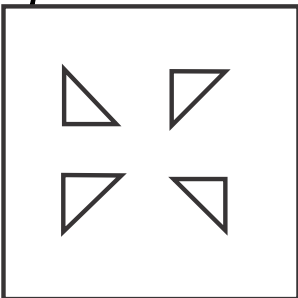

Option 4:

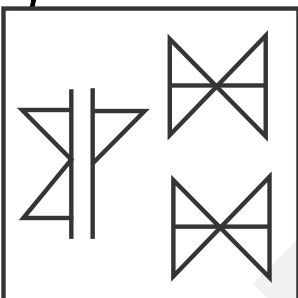

Correct Answer:

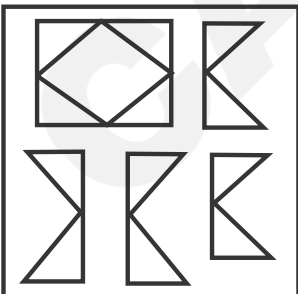

Solution:

The given figure can be numbered as shown below –

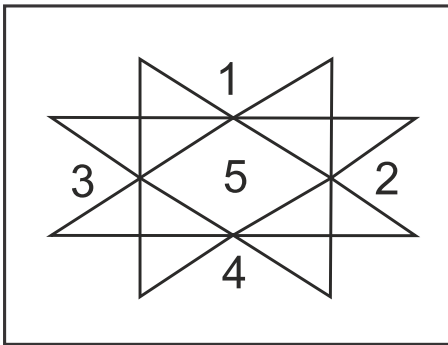

The parts can be arranged in the following manner -

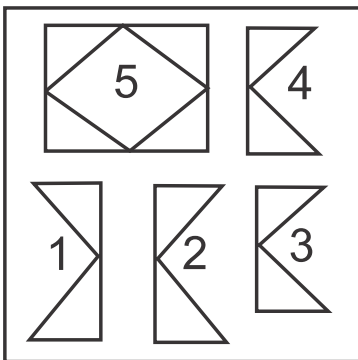

The above-compiled figure matches the figure given in the second option. Hence, the **second option** is correct.

Q. 48 **Directions:** Which answer figure will complete the pattern in the question figure?

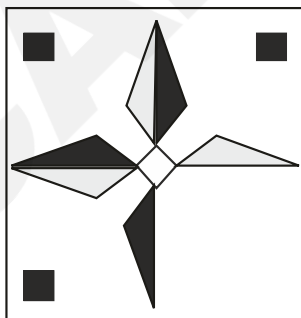

Option 1:

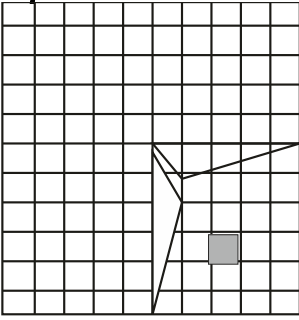

Option 2:

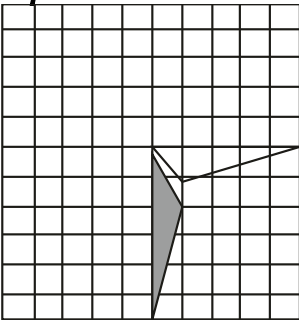

Option 3:

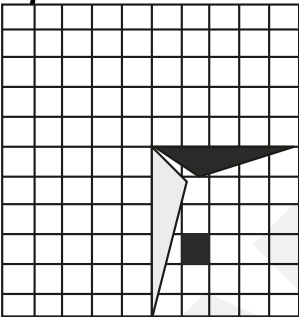

Option 4:

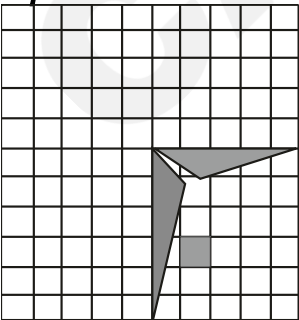

Correct Answer:

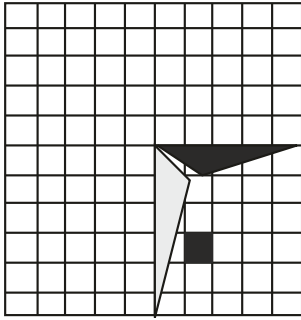

Solution:

On comparing the question figure and all the answer figures, the following figure will combine and make the complete pattern -

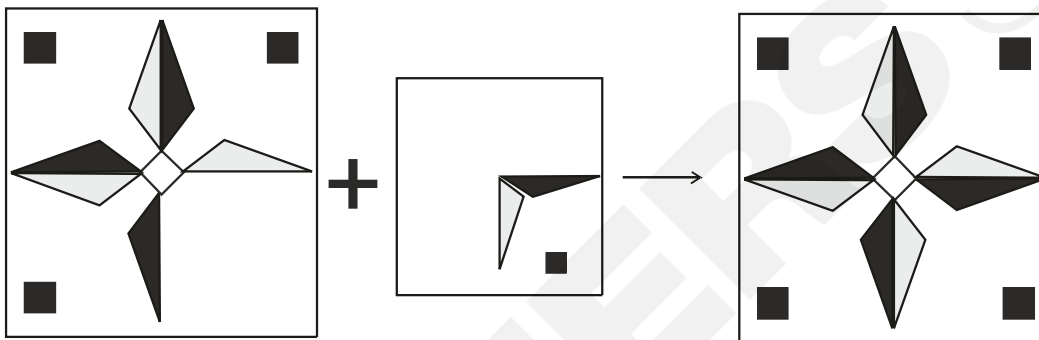

Hence, the **third option** is correct.

Q. 49 **Directions:** Which answer figure will complete the question figure?

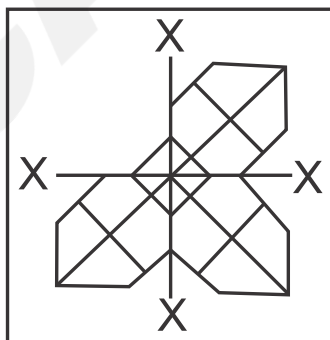

Option 1:



Option 2:

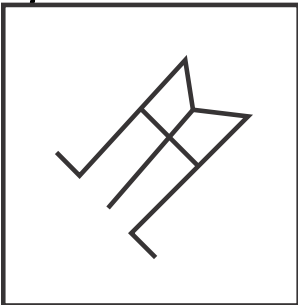

Option 3:

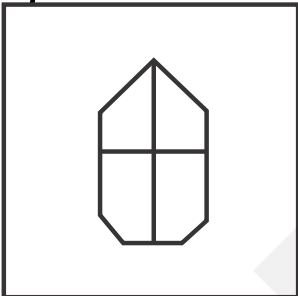

Option 4:

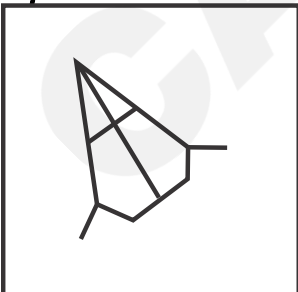

Correct Answer:

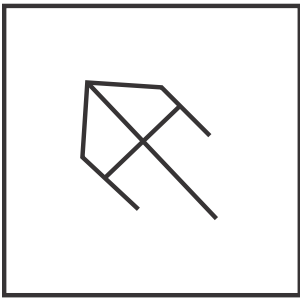

Solution:

On comparing the question figure and all the answer figures, the following figure will combine and make the complete pattern –

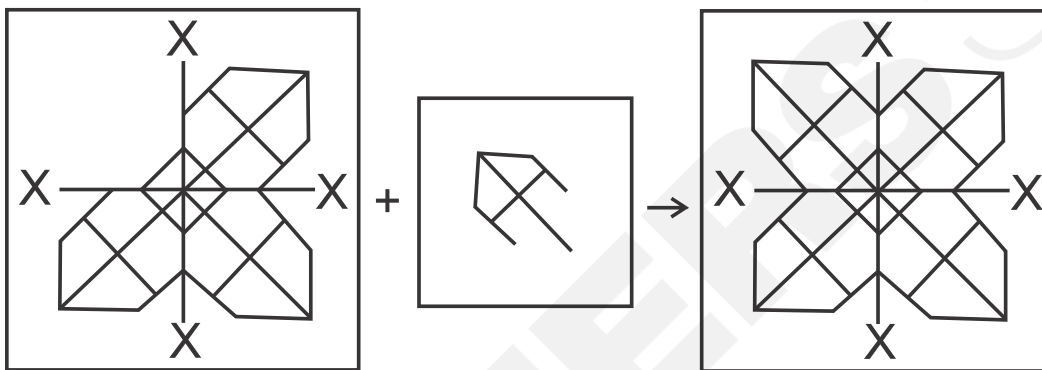

Hence, the **first option** is correct.

Q. 50 **Directions:** Which answer figure will complete the question figure?

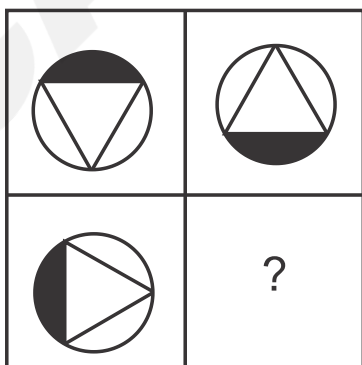

Option 1:

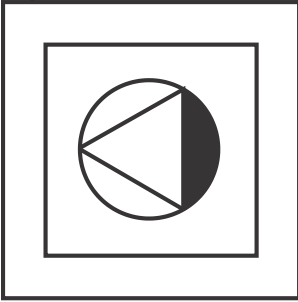

Option 2:

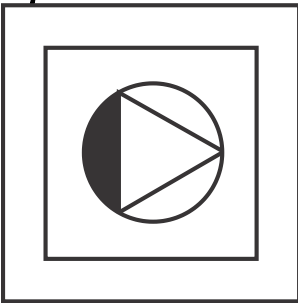

Option 3:

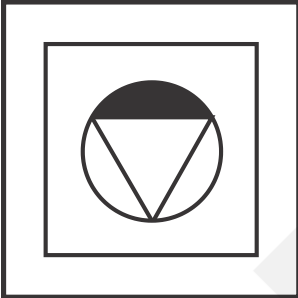

Option 4:



Correct Answer:

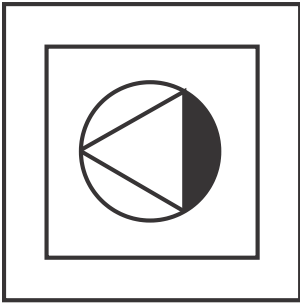

Solution:

On comparing the question figure and all the answer figures, the following figure will combine and make the complete pattern -

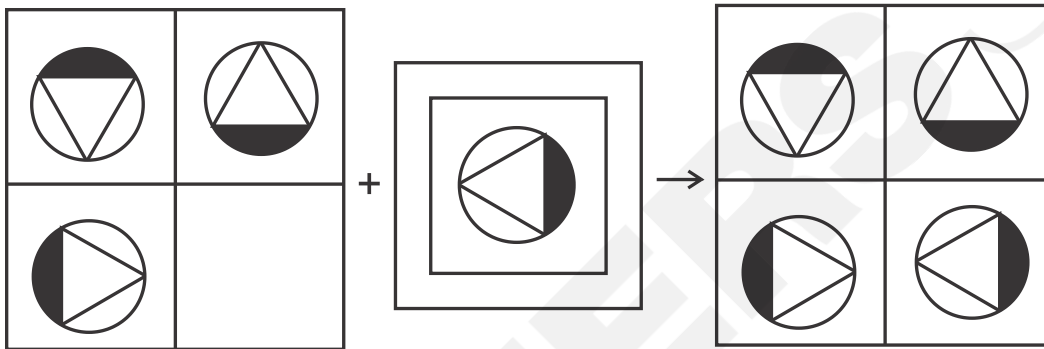

Hence, the **first option** is correct.

Q. 51 **Directions:** Which answer figure will complete the pattern in the question figure?

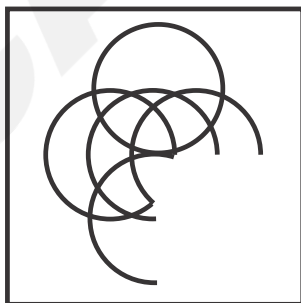

Option 1:

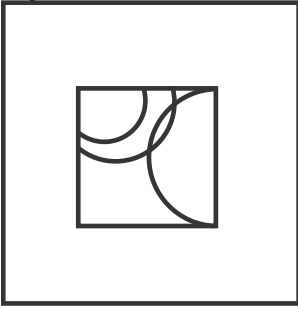

Option 2:

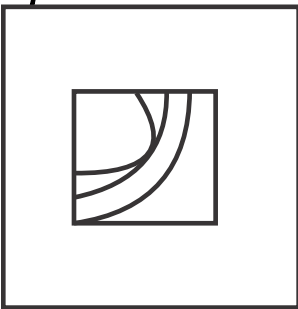

Option 3:



Option 4:

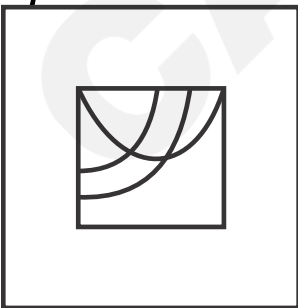

Correct Answer:

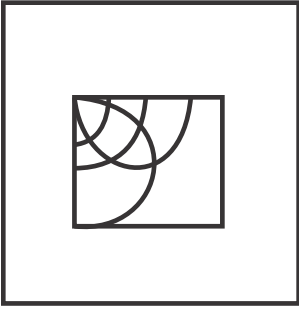

Solution:

On comparing the question figure and all the answer figures, the following figure will combine and make the complete pattern -

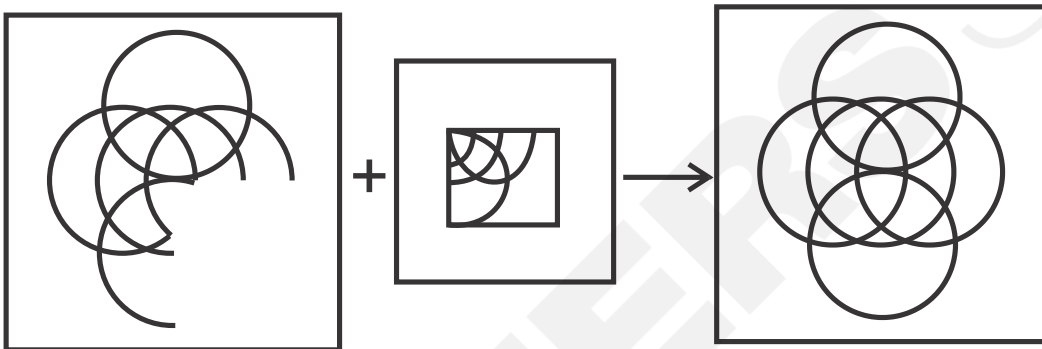

Hence, the **third option** is correct.

Q. 52 **Directions:** Which answer figure will complete the pattern in the question figure?

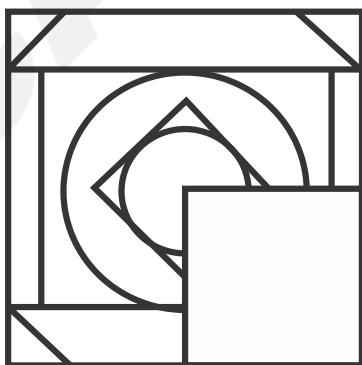

Option 1:

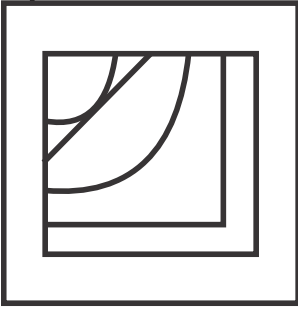

Option 2:

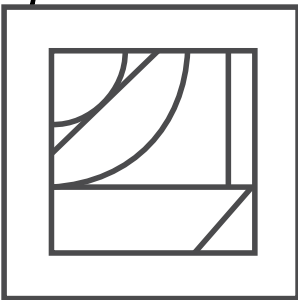

Option 3:

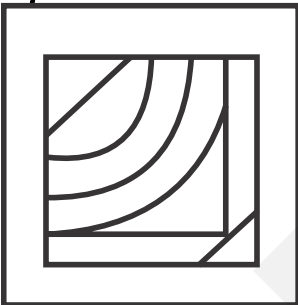

Option 4:

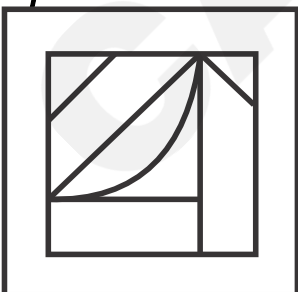

Correct Answer:

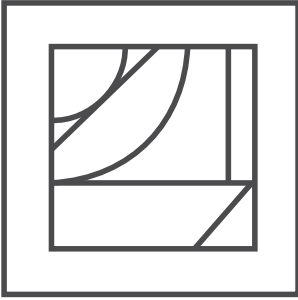

Solution:

On comparing the question figure and all the answer figures, the following figure will combine and make the complete pattern –

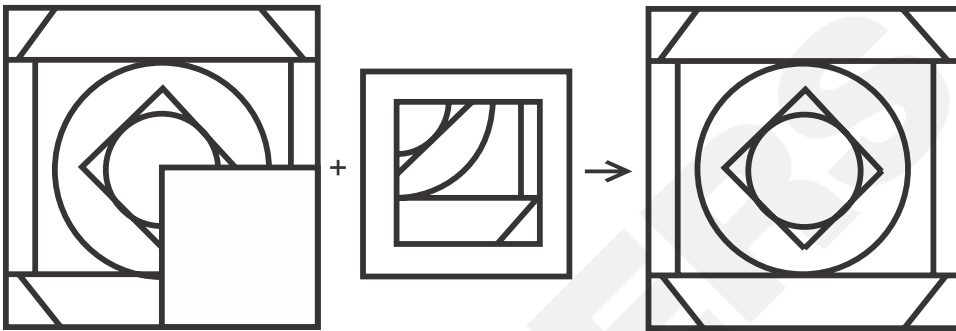

Hence, the **second option** is correct.

Q. 53 **Directions:** Which answer figure will complete the pattern in the question figure?

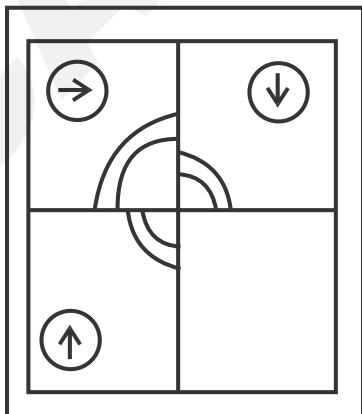

Option 1:

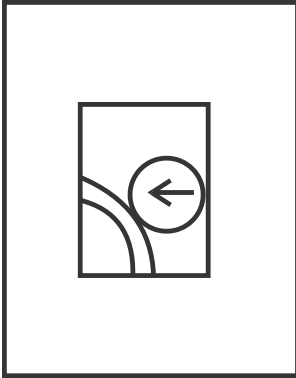

Option 2:

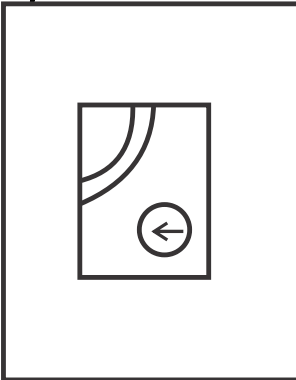

Option 3:

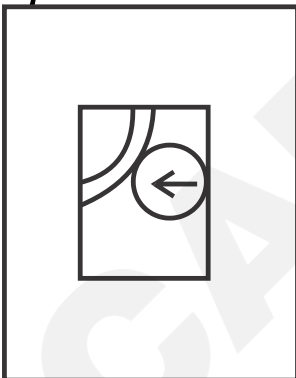

Option 4:

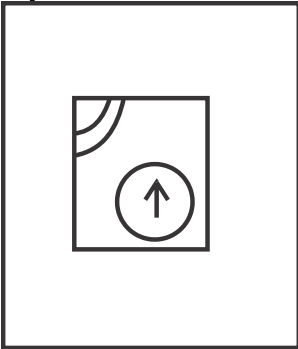

Correct Answer:

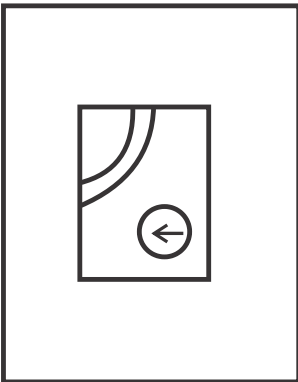

Solution:

On comparing the question figure and all the answer figures, the following figure will combine and make the complete pattern -

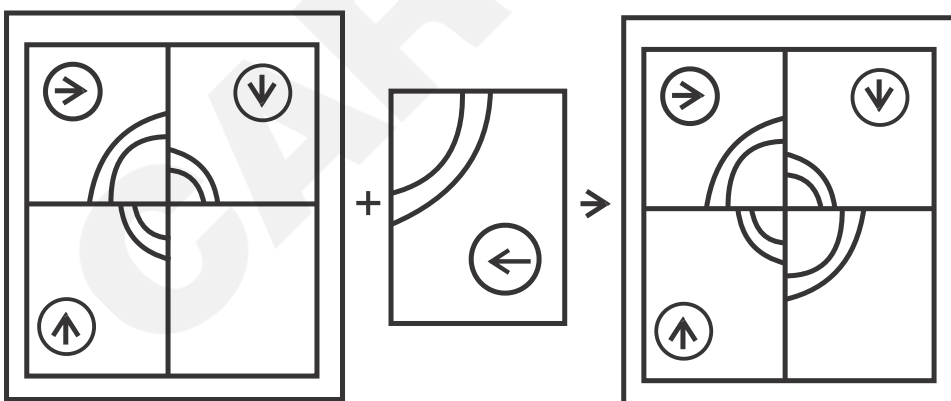

Hence, the **second option** is correct.

- Q. 54** **Directions:** Identify the answer figure that completes the pattern in the question figure.

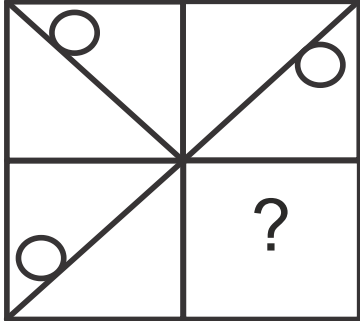

Option 1:

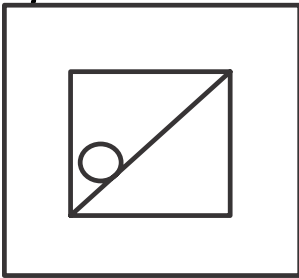

Option 2:

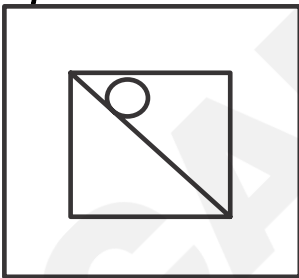

Option 3:

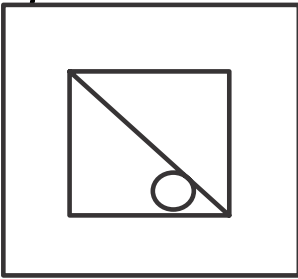

Option 4:

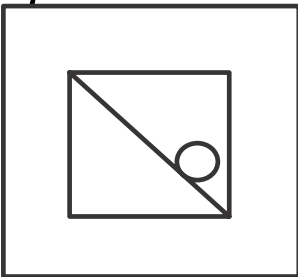

Correct Answer:

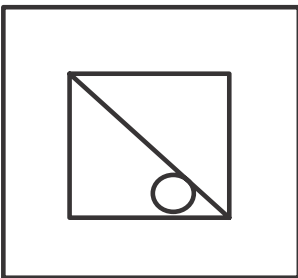

Solution:

On comparing the question figure and all the answer figures, the following figure will combine and make the complete pattern -

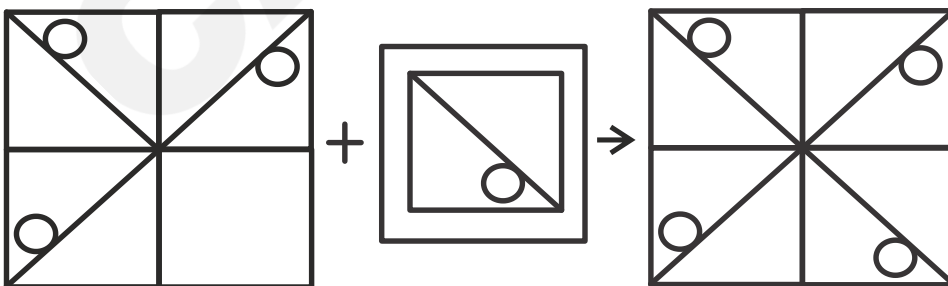

Hence, the **third option** is correct.

Q. 55 **Directions:** Which answer figure will complete the pattern in the question figure?

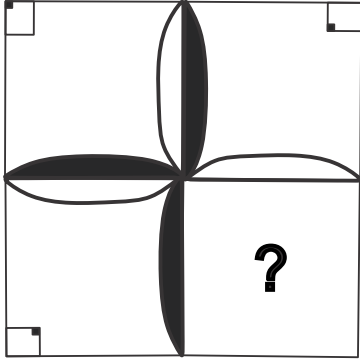

Option 1:

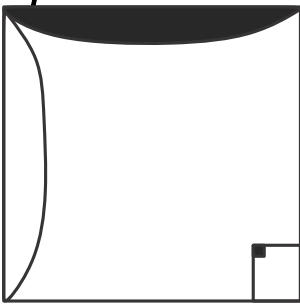

Option 2:

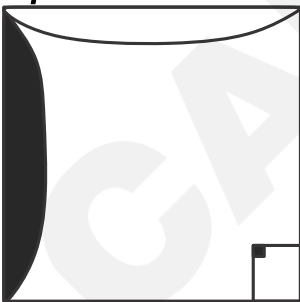

Option 3:

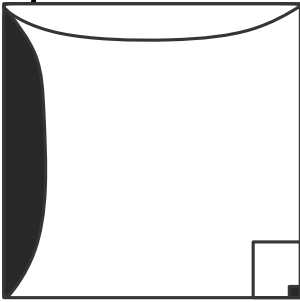

Option 4:

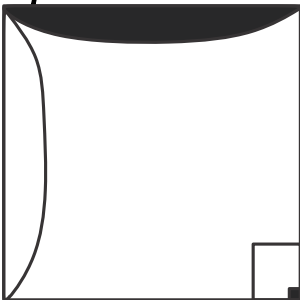

Correct Answer:

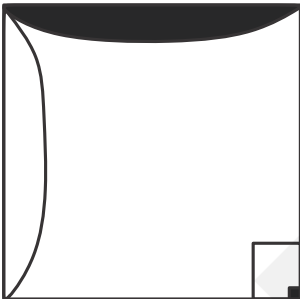

Solution:

On comparing the question figure and all the answer figures, the following figure will combine and make the complete pattern –

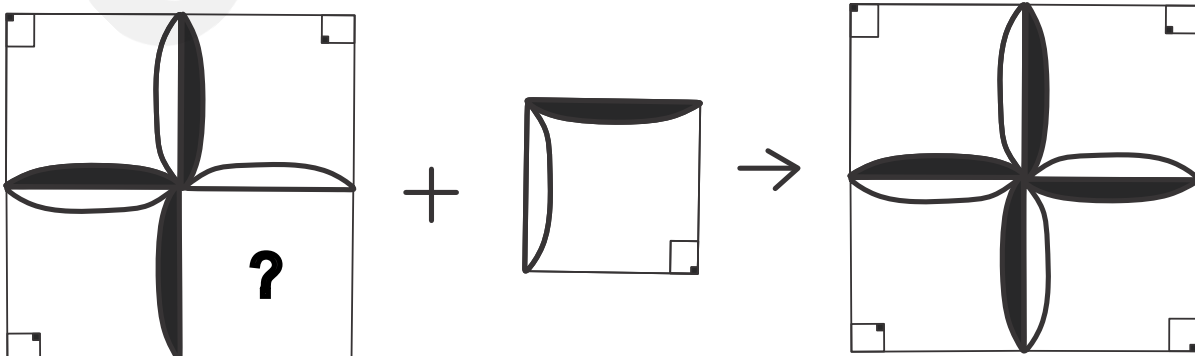

Hence, the **fourth option** is correct.

- Q. 56** **Directions:** Which answer figure will complete the pattern in the question figure?

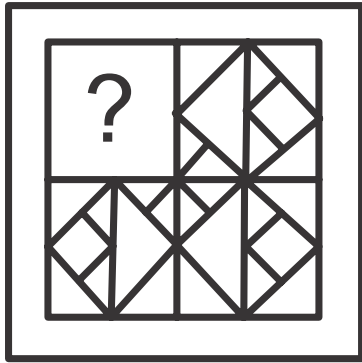

Option 1:

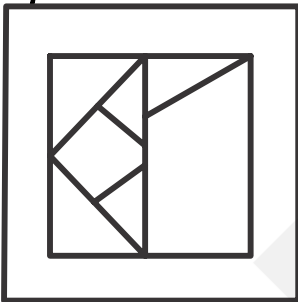

Option 2:

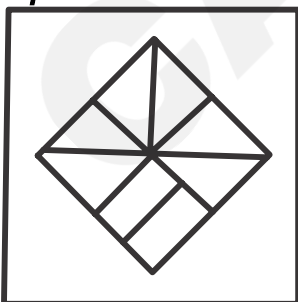

Option 3:

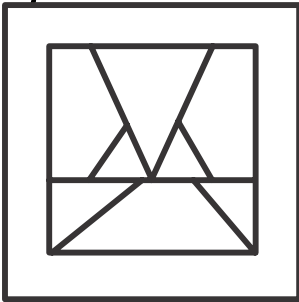

Option 4:

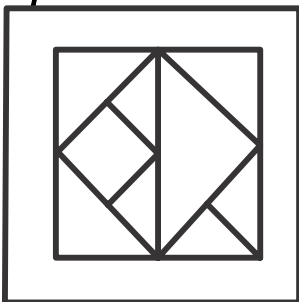

Correct Answer:

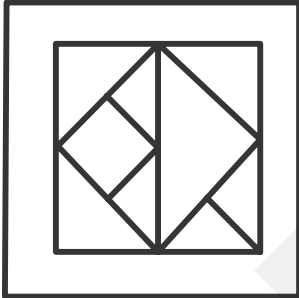

Solution:

On comparing the question figure and all the answer figures, the following figure will combine and make the complete pattern -

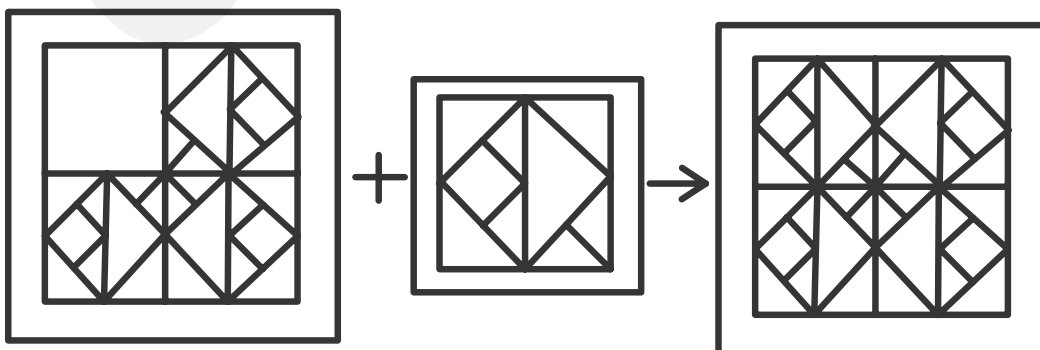

Hence, the **fourth option** is correct.

Q. 57 **Directions:** Which answer figure will complete the pattern in the question figure?

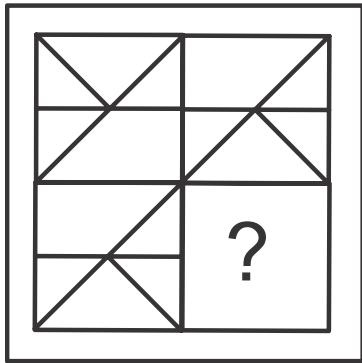

Option 1:

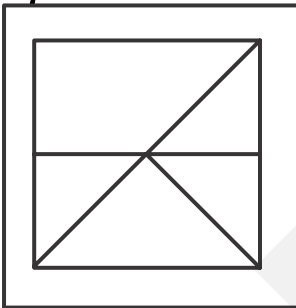

Option 2:

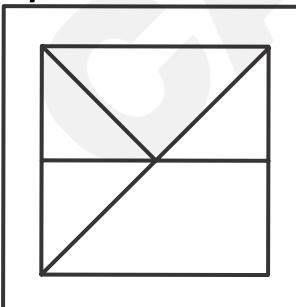

Option 3:

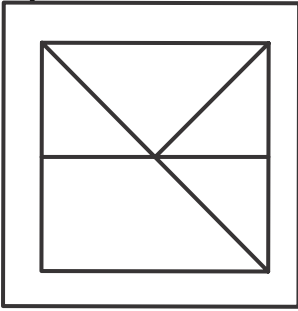

Option 4:

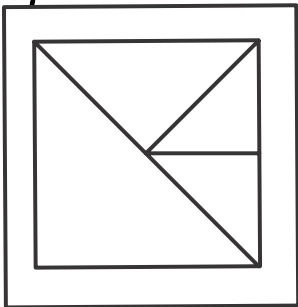

Correct Answer:

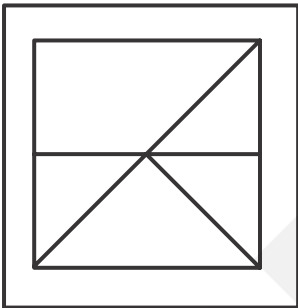

Solution:

On comparing the question figure and all the answer figures, the following figure will combine and make the complete pattern –

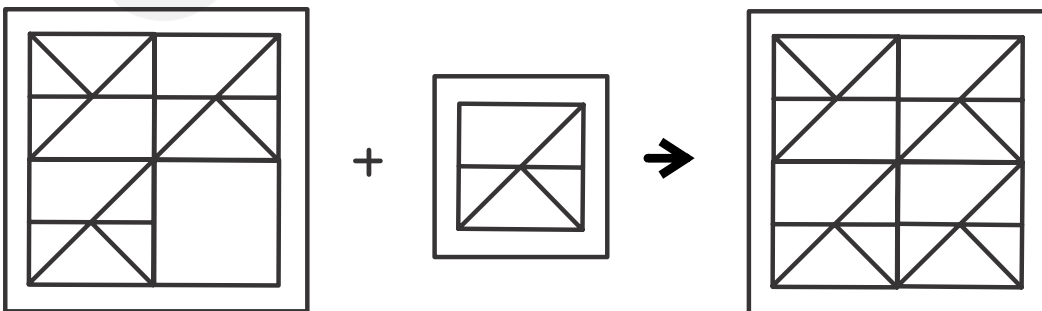

Hence, the **first option** is correct.

- Q. 58** **Directions:** Which answer figure will complete the pattern in the question figure?

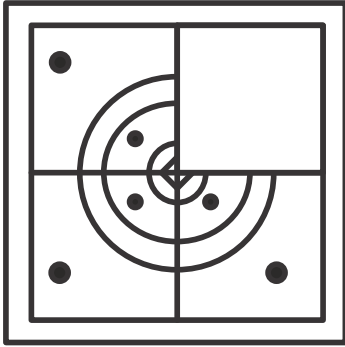

Option 1:

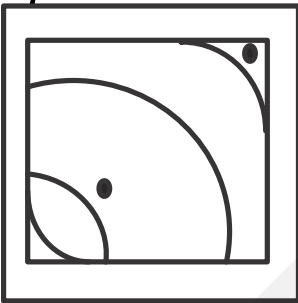

Option 2:

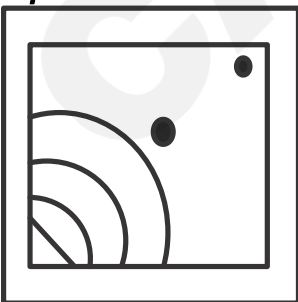

Option 3:

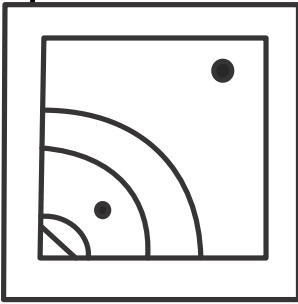

Option 4:

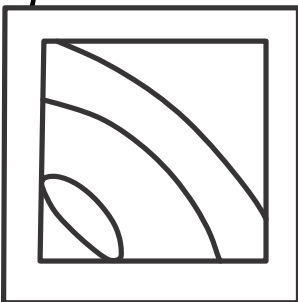

Correct Answer:

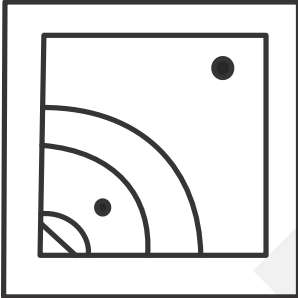

Solution:

On comparing the question figure and all the answer figures, the following figure will combine and make the complete pattern -

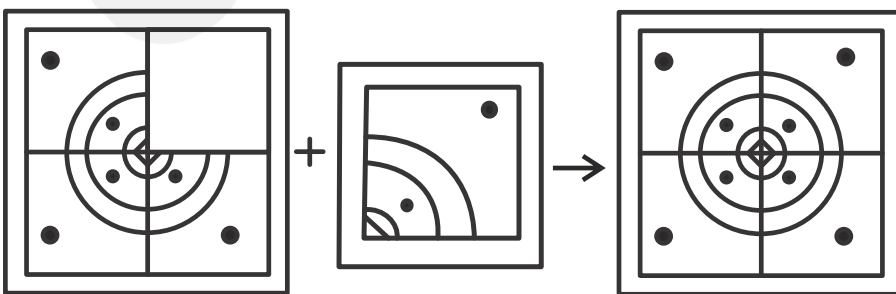

Hence, the **third option** is correct.

- Q. 59** **Directions:** Which answer figure will complete the pattern in the question figure?

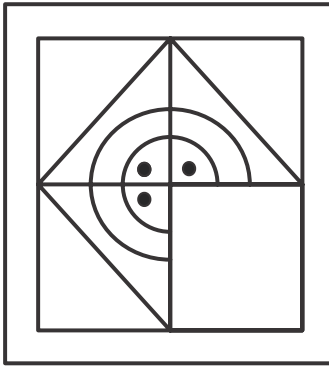

Option 1:

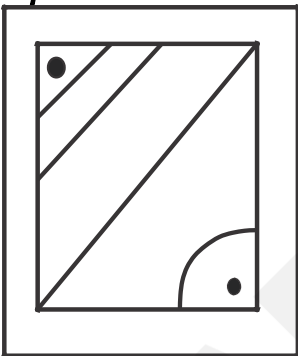

Option 2:

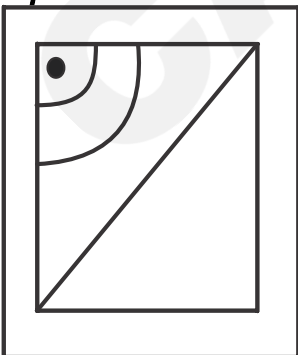

Option 3:

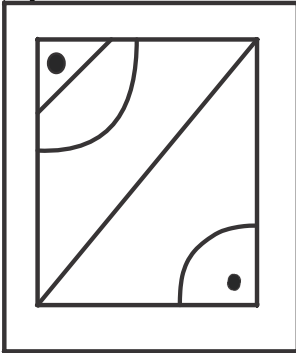

Option 4:

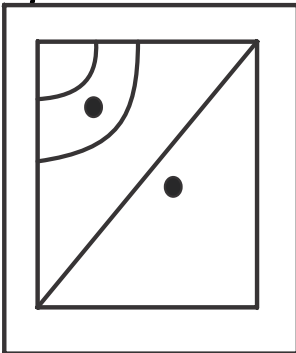

Correct Answer:



Solution:

On comparing the question figure and all the answer figures, the following figure will combine and make the complete pattern –

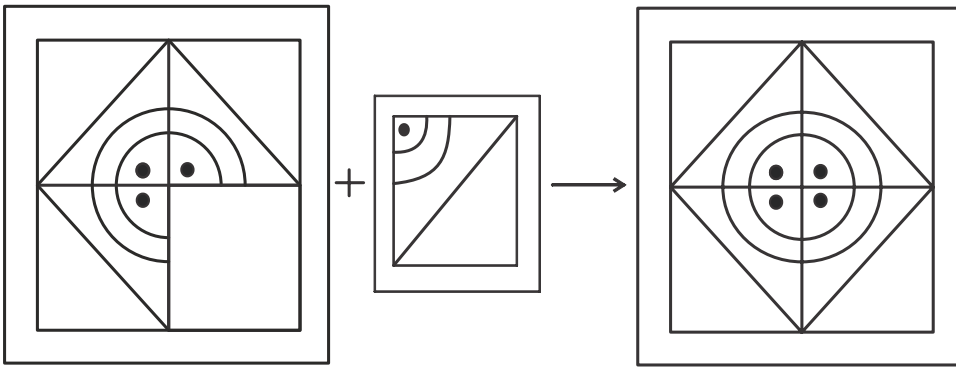

Hence, the **second option** is correct.

Q. 60 **Directions:** Which answer figure will complete the pattern in the question figure?

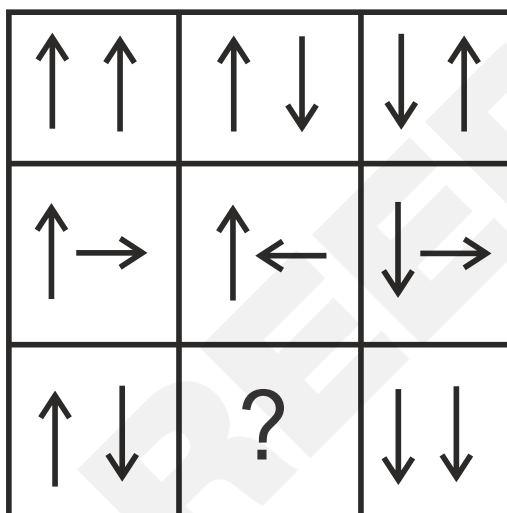

Option 1:

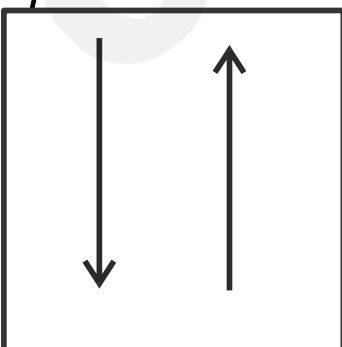

Option 2:

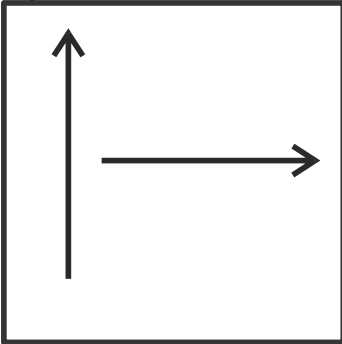

Option 3:

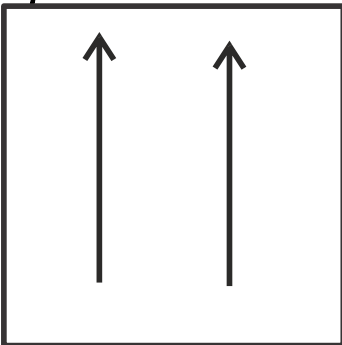

Option 4:

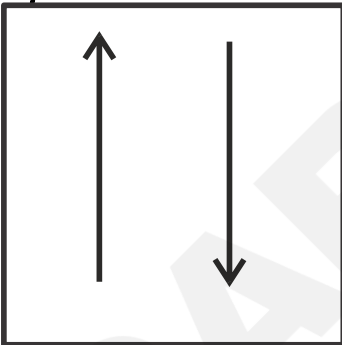

Correct Answer:

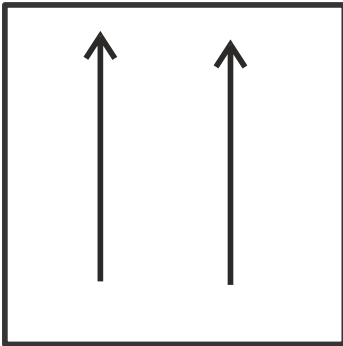

Solution:

On comparing the question figure and all the answer figures, the following figure will combine and make the complete pattern –

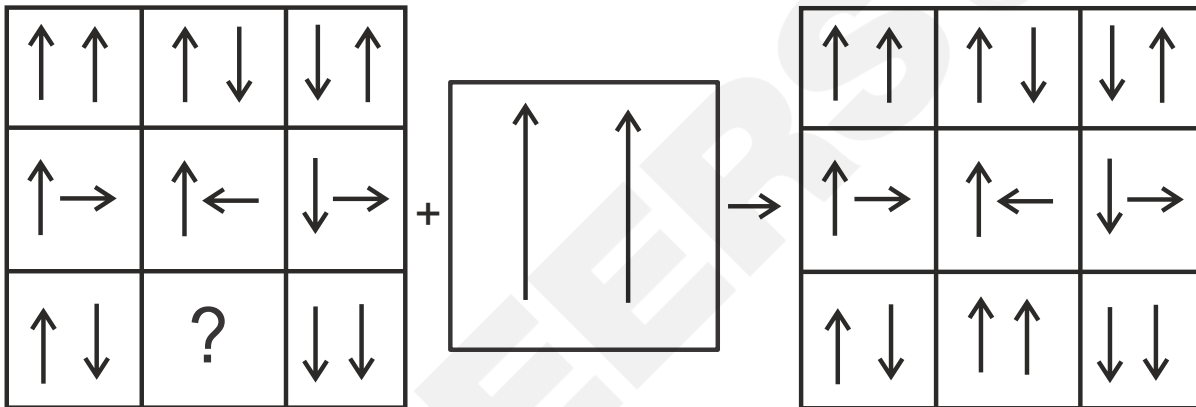

Hence, the **third option** is correct.

- Q. 61** **Directions:** In the following question, among the four answer figures, which can be formed from the cutout pieces given below?

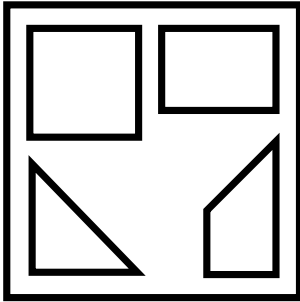

Option 1:

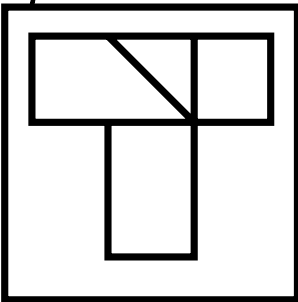

Option 2:

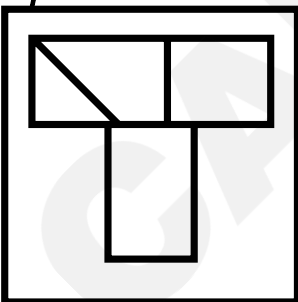

Option 3:

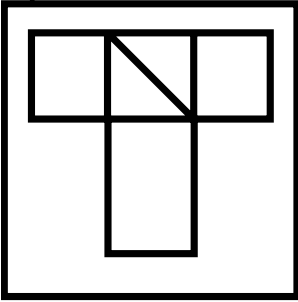

Option 4:

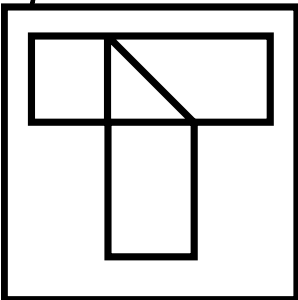

Correct Answer:

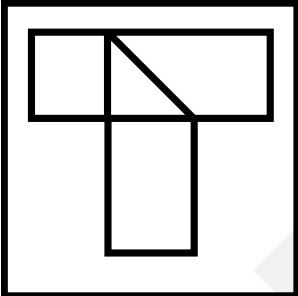

Solution:

The various parts of the figure can be numbered as follows –

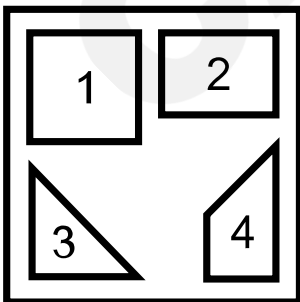

The parts can be arranged in the following manner –

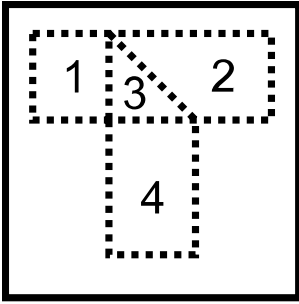

Hence, the **fourth option** is correct.

- Q. 62** **Directions:** Among the four answer figures, which can be formed from the cutout pieces in the question figure below?

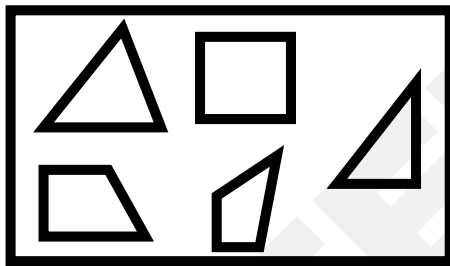

Option 1:

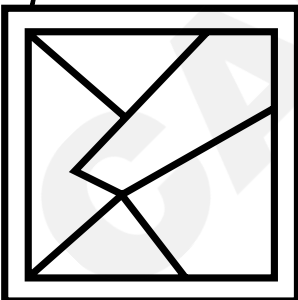

Option 2:

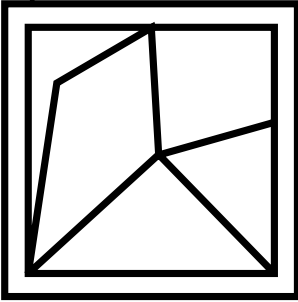

Option 3:

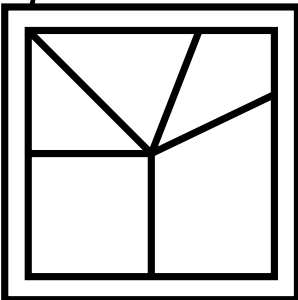

Option 4:

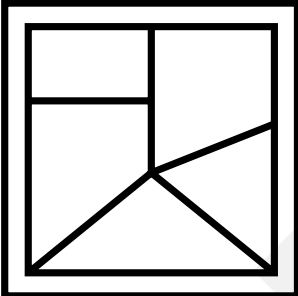

Correct Answer:

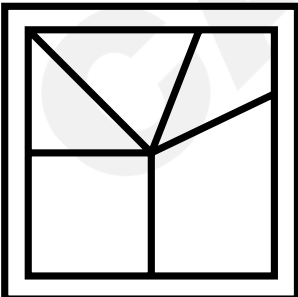

Solution:

The various parts of the figure can be numbered as follows –

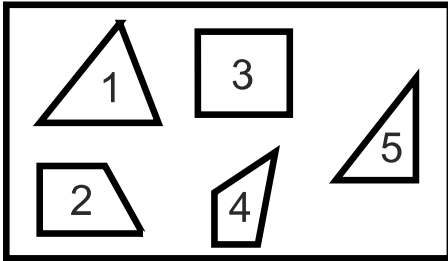

The parts can be arranged in the following manner –

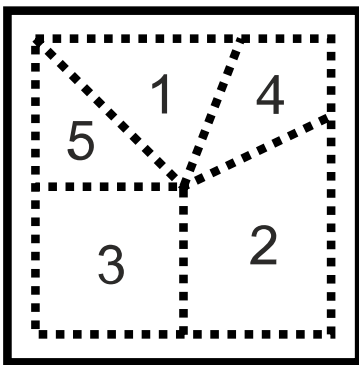

Hence, the **third option** is correct.

Q. 63 **Directions:** Identify the figure that completes the pattern.

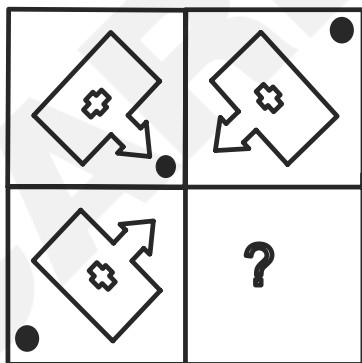

Option 1:

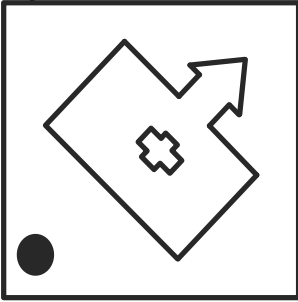

Option 2:

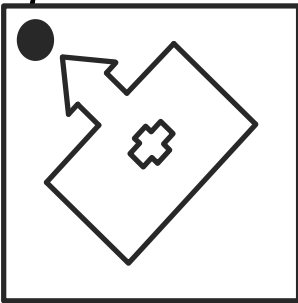

Option 3:

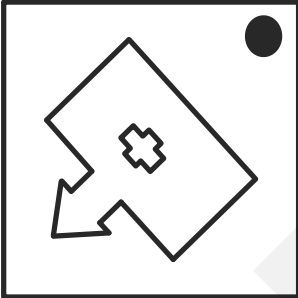

Option 4:

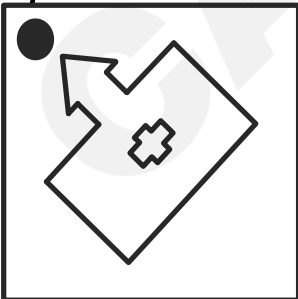

Correct Answer:

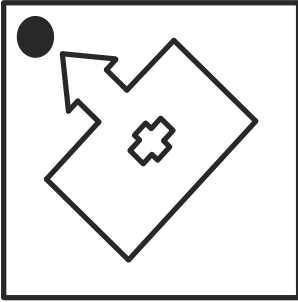

Solution:

On comparing the question figure and all the answer figures, the following figure will combine and make the complete pattern -

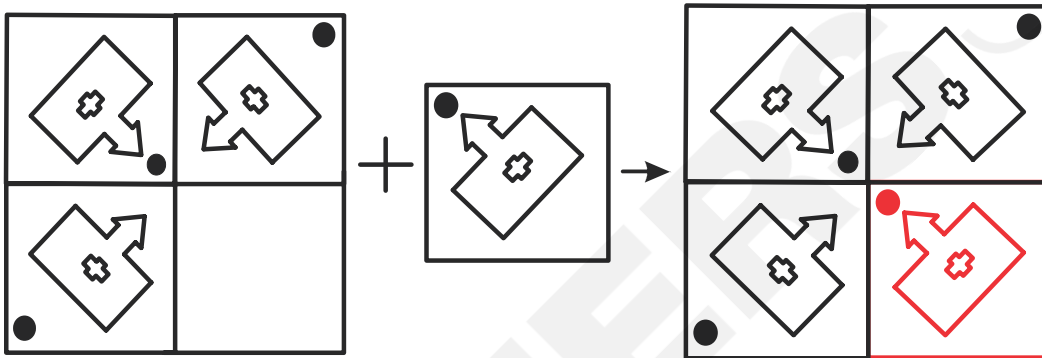

Hence, the **second option** is correct.

Q. 64 **Directions:** Identify the figure that completes the pattern.

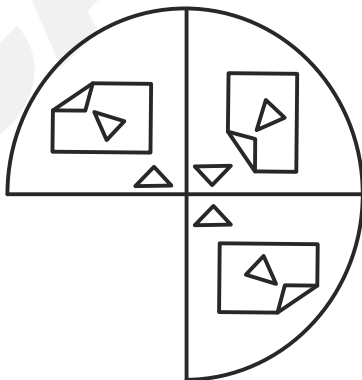

Option 1:

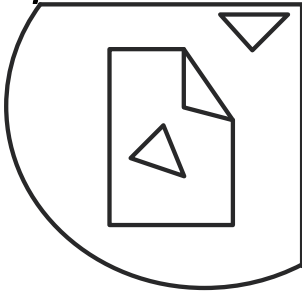

Option 2:

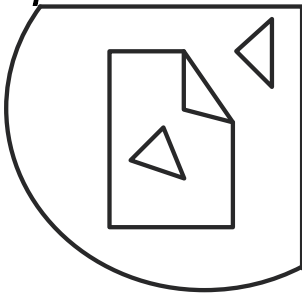

Option 3:

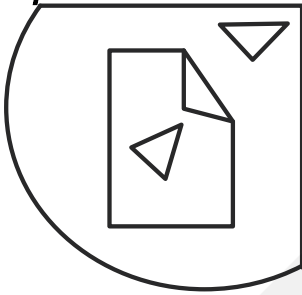

Option 4:

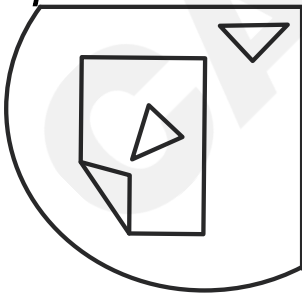

Correct Answer:

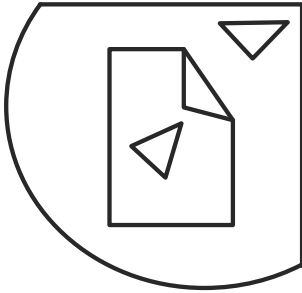

Solution:

On comparing the question figure and all the answer figures, the following figure will combine and make the complete pattern -

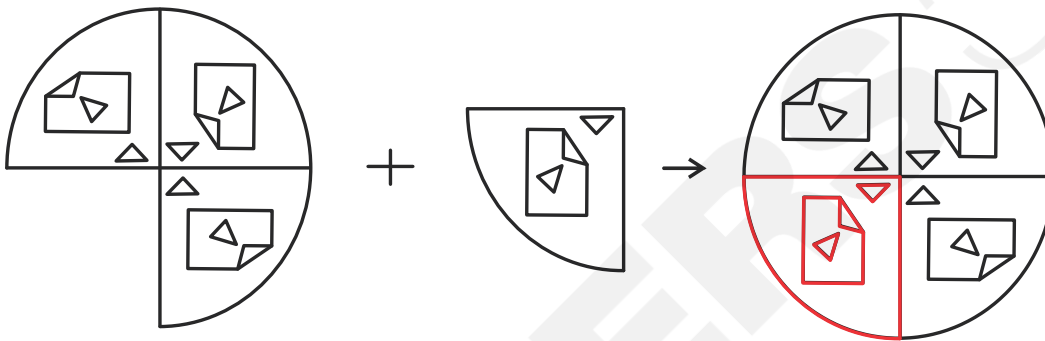

Hence, the **third option** is correct.

Q. 65 **Directions:** In the following question which answer figure will complete the pattern in the question figure?

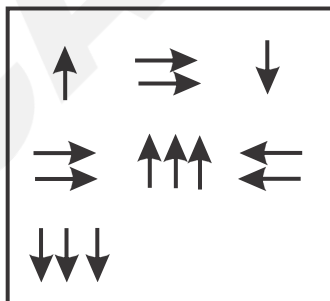

Option 1:

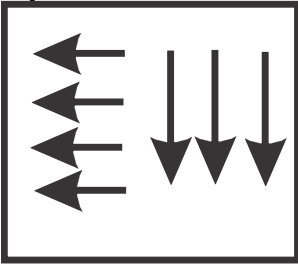

Option 2:

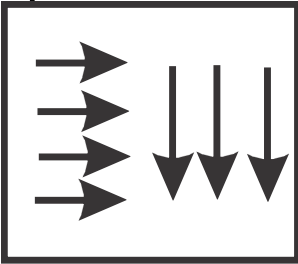

Option 3:

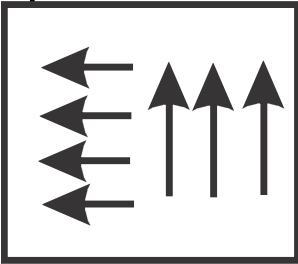

Option 4:

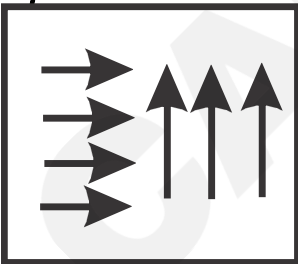

Correct Answer:

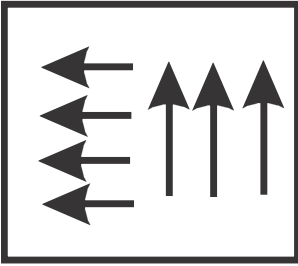

Solution:

According to the given figure –

In column one: The Arrow is rotated by 90° in a clockwise direction and the number of arrows has been increased by 1 in each row.

In column two: The Arrow is rotated by 90° in an anticlockwise direction and the number of arrows has been increased by 1 in each row.

In column three: The Arrow is rotated by 90° in a clockwise direction and the number of arrows has been increased by 1 in each row.

So, by following the same pattern the required missing figure that will complete the question image is –

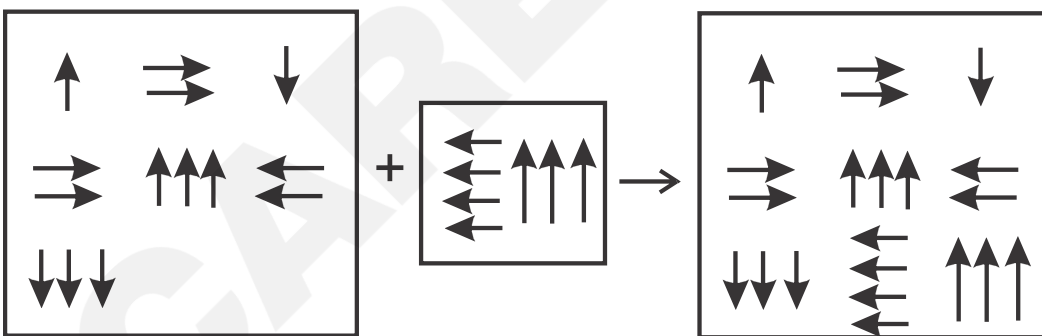

Hence, the **third option** is correct.

- Q. 66** **Directions:** Find the answer figure which will complete the pattern in the question figure.

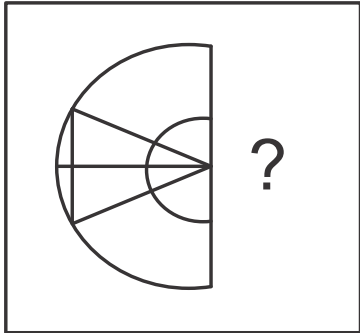

Option 1:

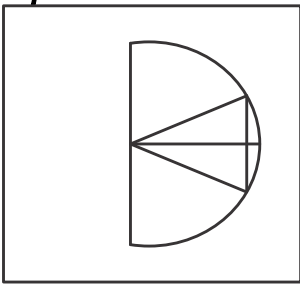

Option 2:

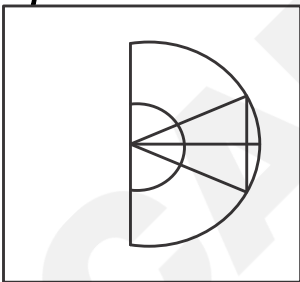

Option 3:

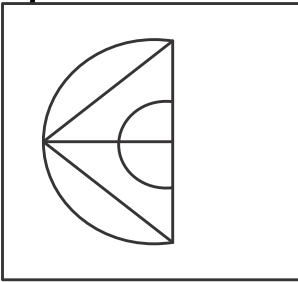

Option 4:

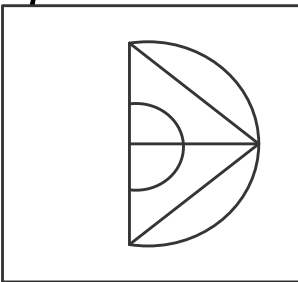

Correct Answer:

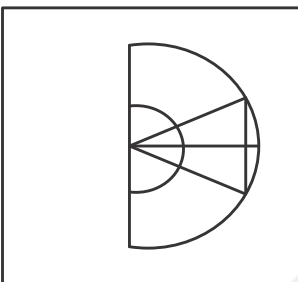

Solution:

On comparing the question figure and all the answer figures, the following figure will combine and make the complete pattern -

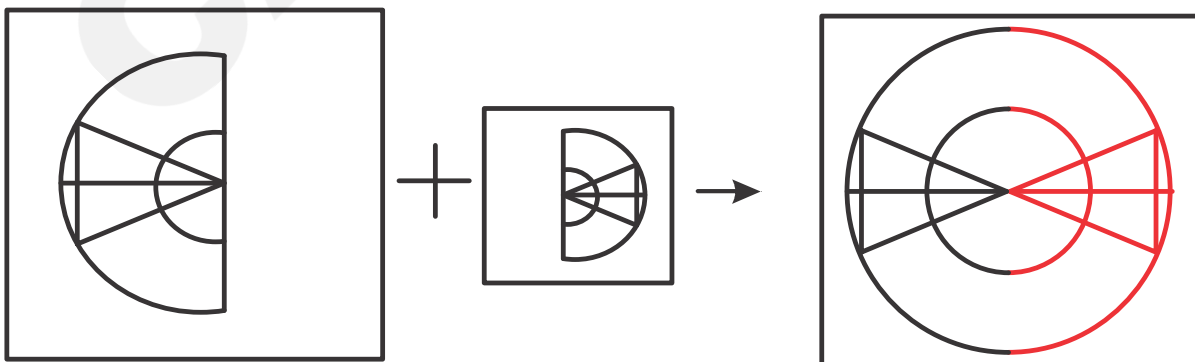

Hence, the **second option** is correct.

- Q. 67** **Directions:** Find the answer figure which will complete the pattern in the question figure.

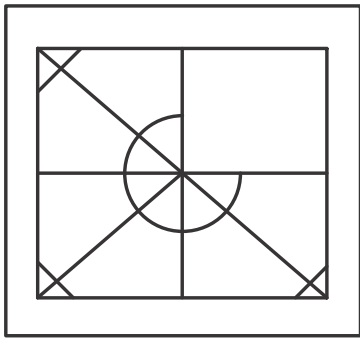

Option 1:

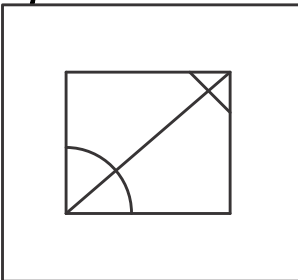

Option 2:

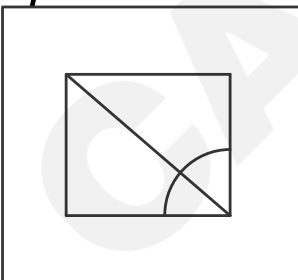

Option 3:

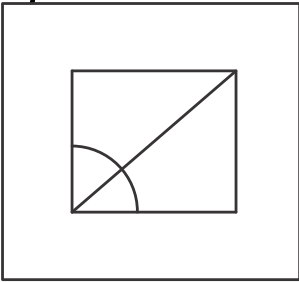

Option 4:

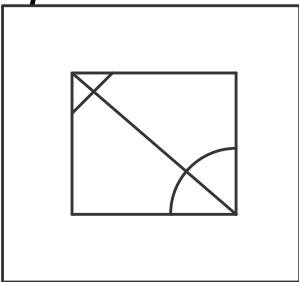

Correct Answer:

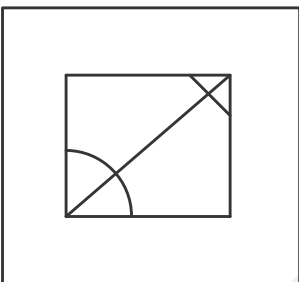

Solution:

On comparing the question figure and all the answer figures, the following figure will combine and make the complete pattern -

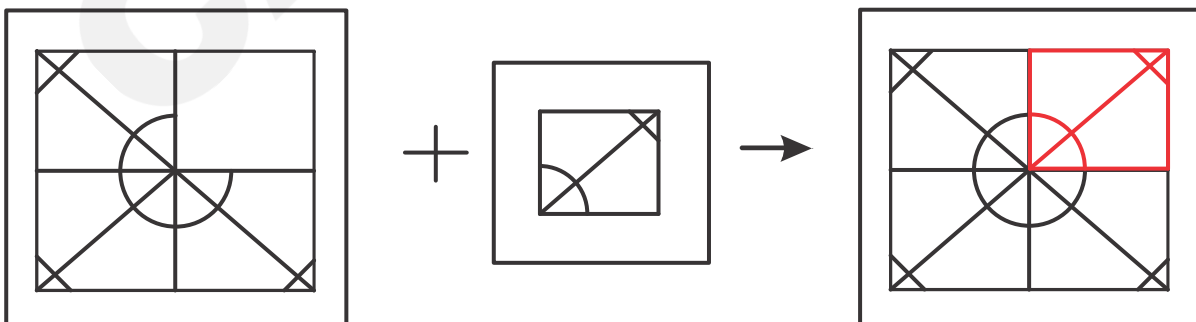

Hence, the **first option** is correct.

- Q. 68** **Directions:** In the following question, which answer figure will complete the pattern in the question figure?

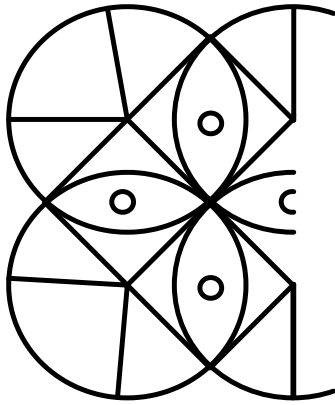

Option 1:

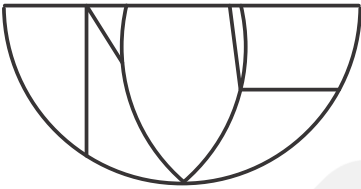

Option 2:

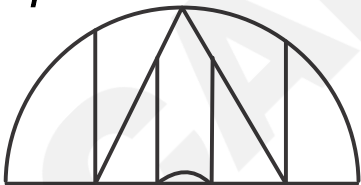

Option 3:

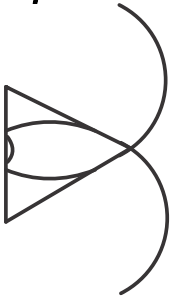

Option 4:

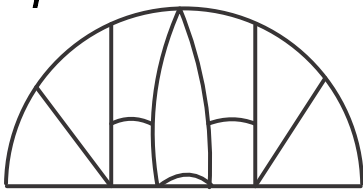

Correct Answer:

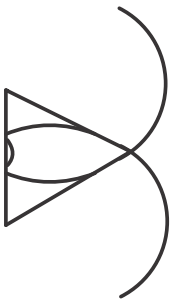

Solution:

On comparing the question figure and all the answer figures, the following figure will combine and make the complete pattern -

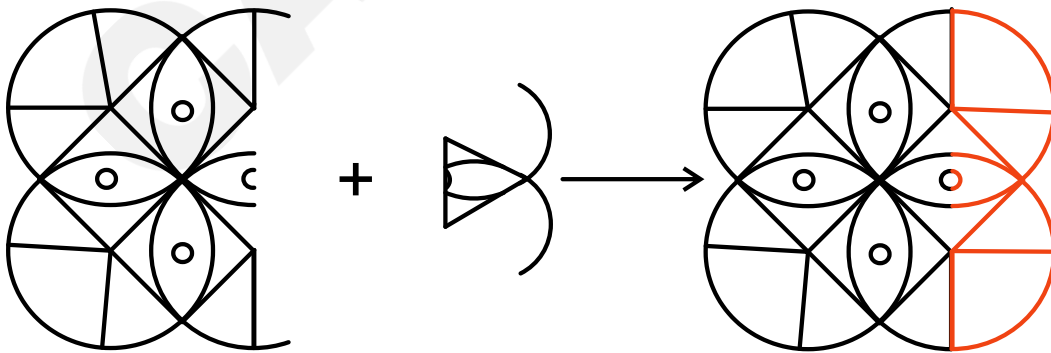

Hence, the **third option** is correct.

- Q. 69** **Directions:** In the following question, which answer figure will complete the pattern in the question figure?

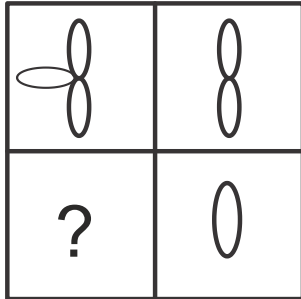

Option 1:

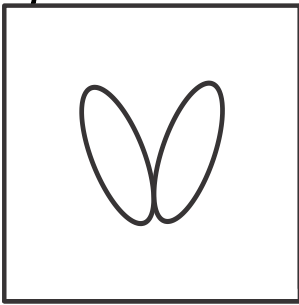

Option 2:



Option 3:

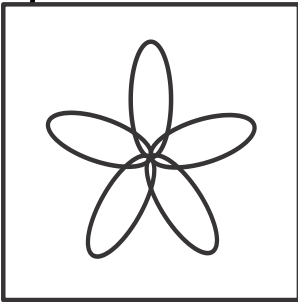

Option 4:

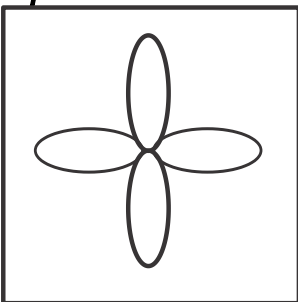

Correct Answer:

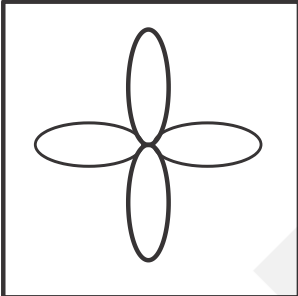

Solution:

On comparing the question figure and all the answer figures, the following figure will combine and make the complete pattern -

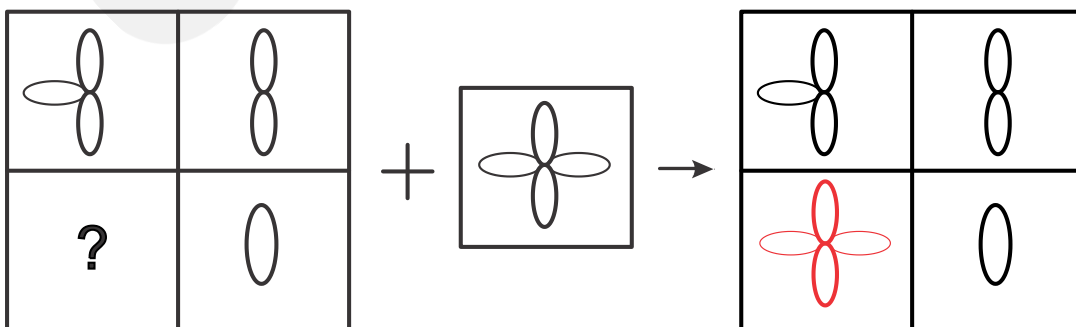

Hence, the **fourth option** is correct.

- Q. 70** **Directions:** In the following question, which answer figure will complete the question figure?

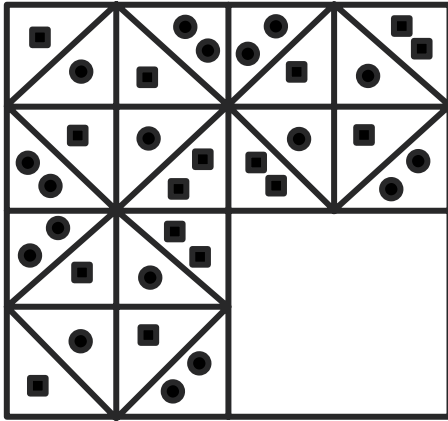

Option 1:

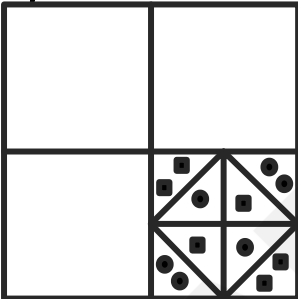

Option 2:

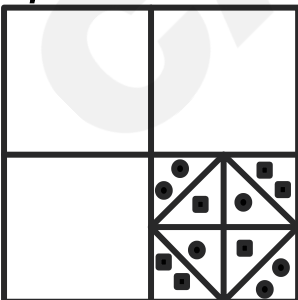

Option 3:

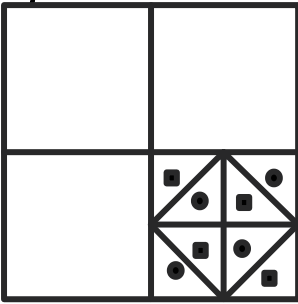

Option 4:

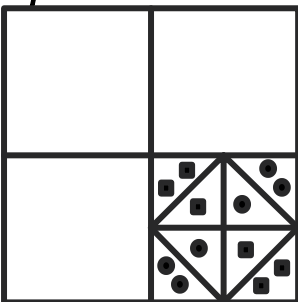

Correct Answer:

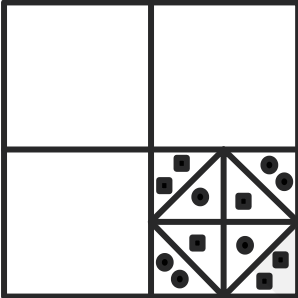

Solution:

On comparing the question figure and all the answer figures, the following figure will combine and make the complete pattern -

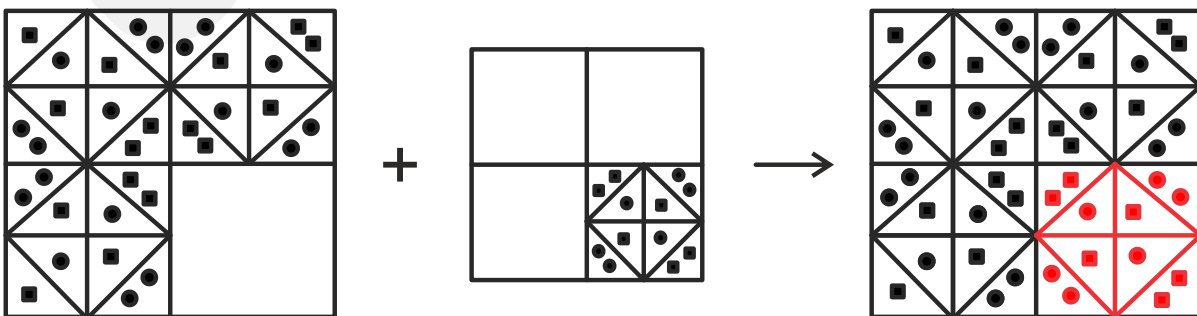

Hence, the **first option** is correct.

- Q. 71** **Directions:** In the following question, which answer figure will complete the question figure?

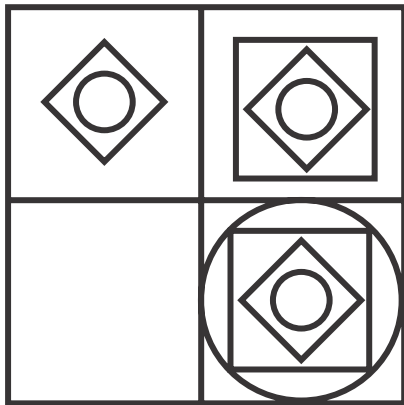

Option 1:

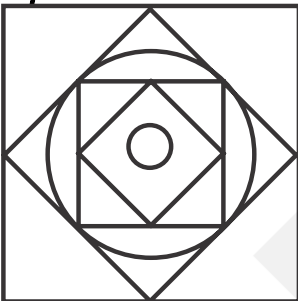

Option 2:

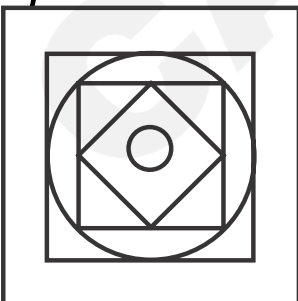

Option 3:

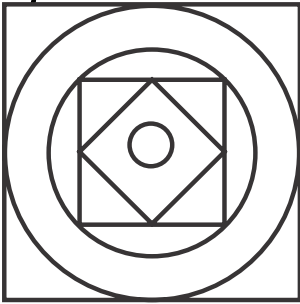

Option 4:

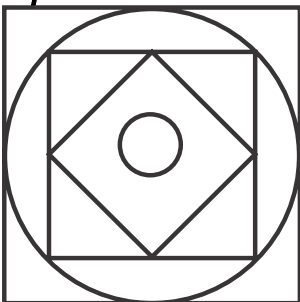

Correct Answer:

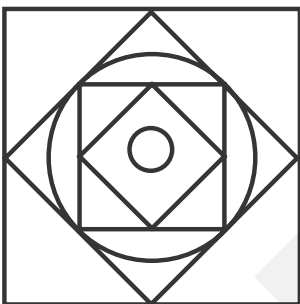

Solution:

According to the given figure –

In the top left corner – A circle is surrounded by a rhombus.

In the top right corner – The image of the top left corner is surrounded by a square.

In the bottom right corner – The image in the top right corner is surrounded by a circle.

So, for the missing figure, the previous must be surrounded by a rhombus –

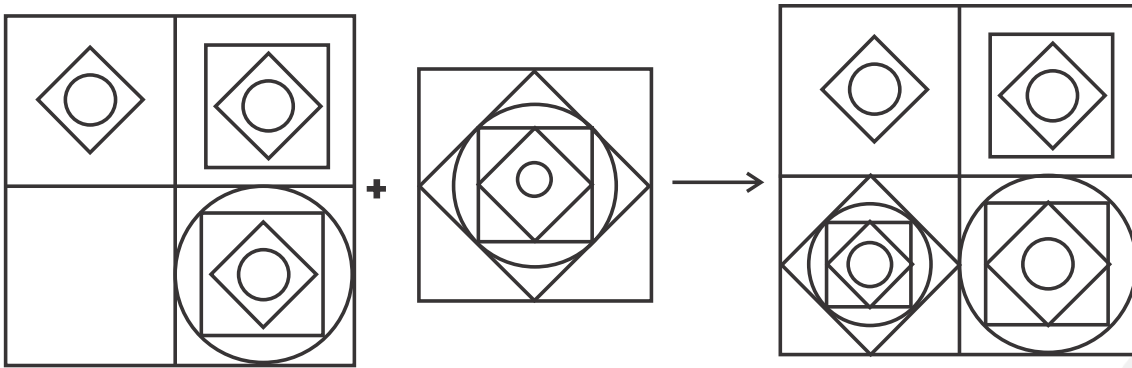

Hence, the **first option** is correct.

- Q. 72** **Directions:** In the following question, which answer figure will complete the question figure?

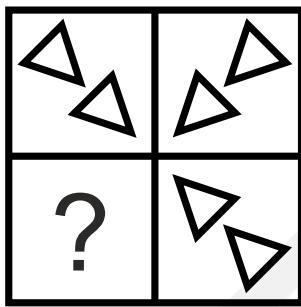

Option 1:

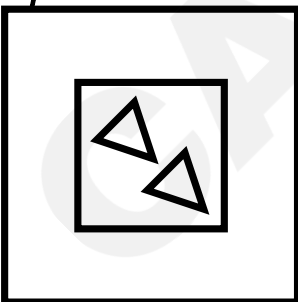

Option 2:

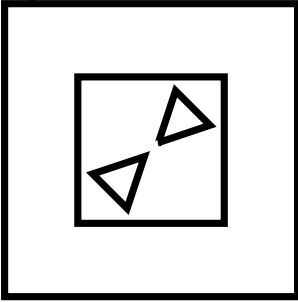

Option 3:

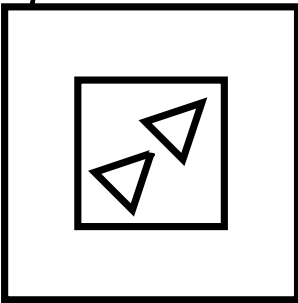

Option 4:

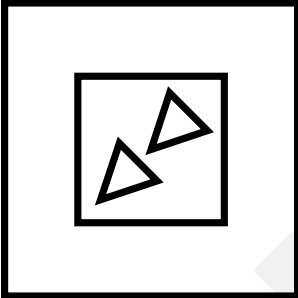

Correct Answer:

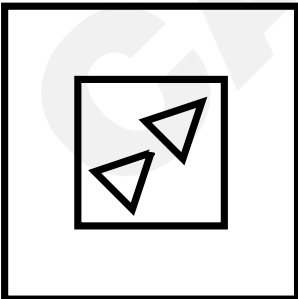

Solution:

On comparing the question figure and all the answer figures, the following figure will combine and make the complete pattern -

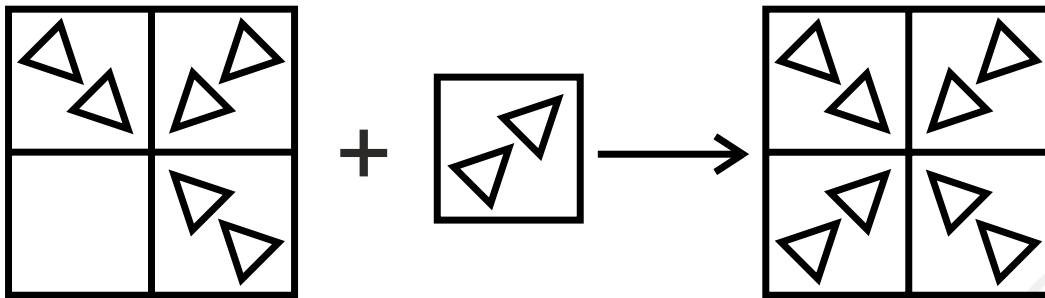

Hence, the **third option** is correct.

- Q. 73** **Directions:** In the following question, which answer figure will complete the pattern in the question figure?

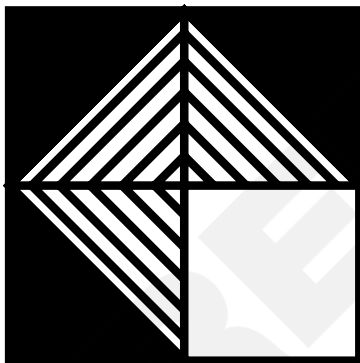

Option 1:

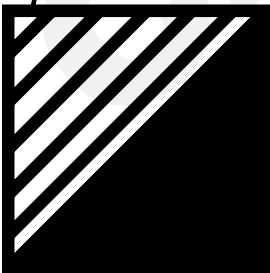

Option 2:

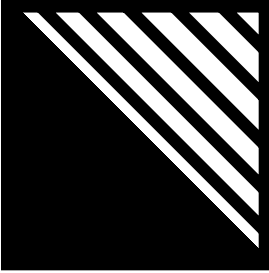

Option 3:

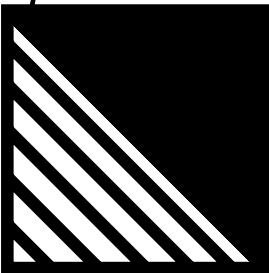

Option 4:

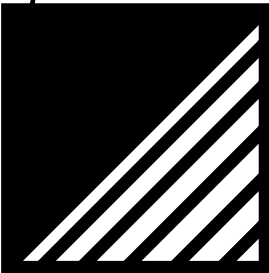

Correct Answer:

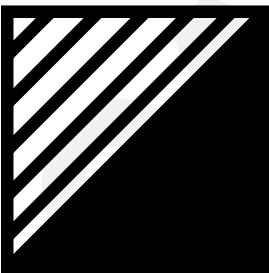

Solution:

On comparing the question figure and all the answer figures, the following figure will combine and make the complete pattern -

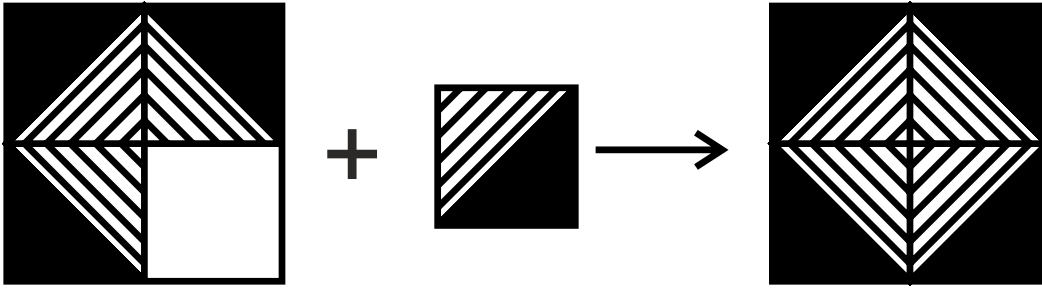

Hence, the **first option** is correct.

- Q. 74** **Directions:** In the following question, which answer figure will complete the pattern in the question figure?

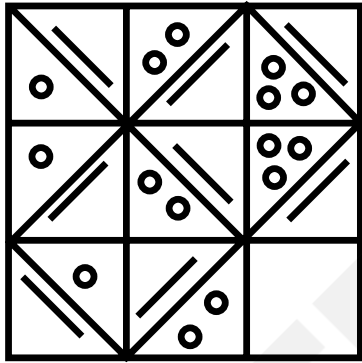

Option 1:

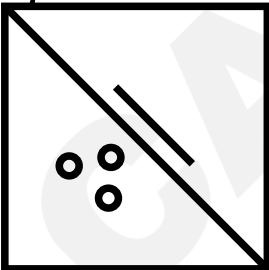

Option 2:

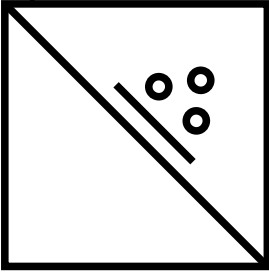

Option 3:

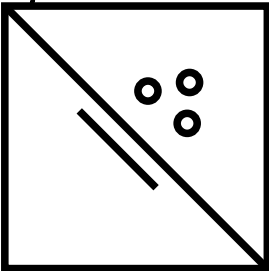

Option 4:

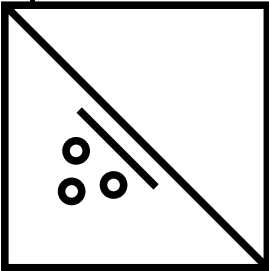

Correct Answer:

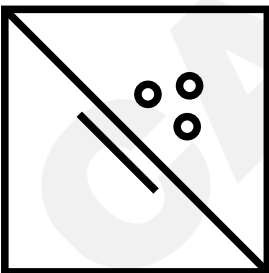

Solution:

On comparing the question figure and all the answer figures, the following figure will combine and make the complete pattern -

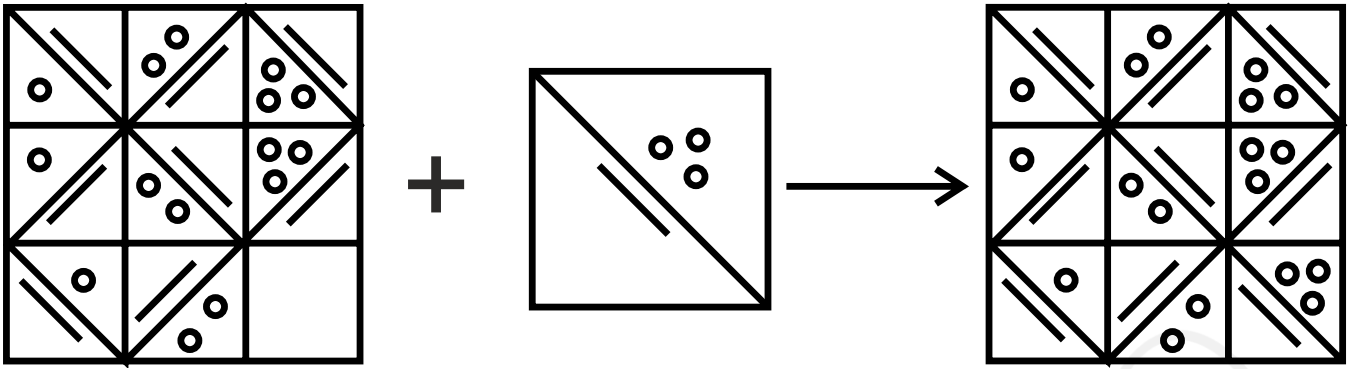

Hence, the **third option** is correct.

Q. 75 **Directions:** Which answer figure will complete the question figure?

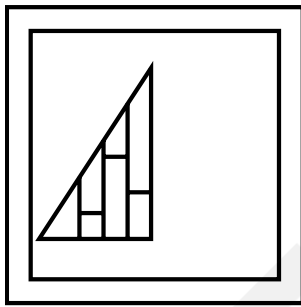

Option 1:

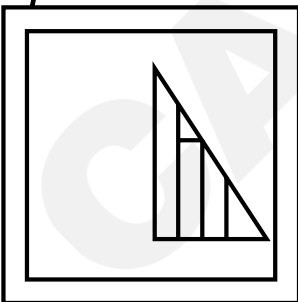

Option 2:

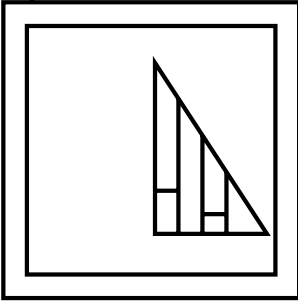

Option 3:

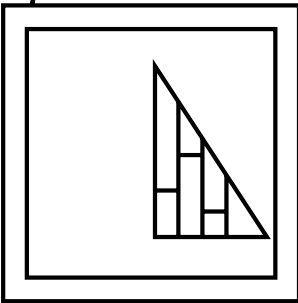

Option 4:

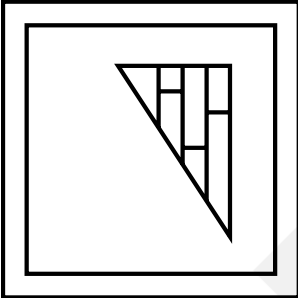

Correct Answer:

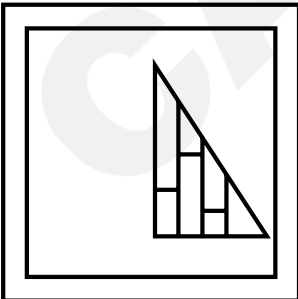

Solution:

On comparing the question figure and all the answer figures, the following figure will combine and make the complete pattern -

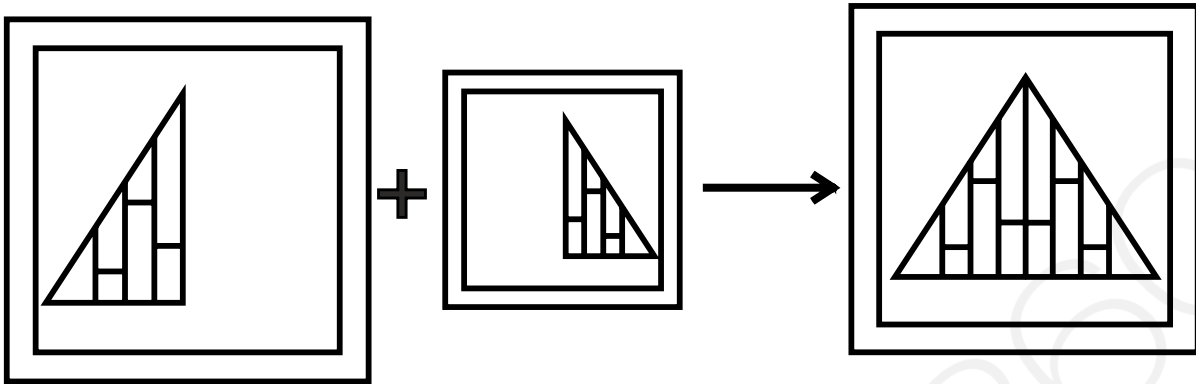

Hence, the **third option** is correct.

Q. 76 **Directions:** Which answer figure will complete the question figure?

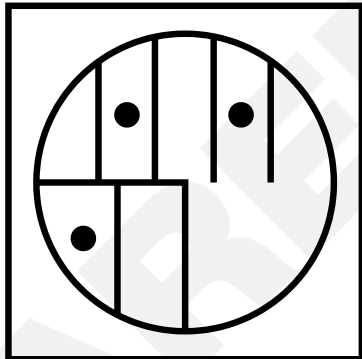

Option 1:

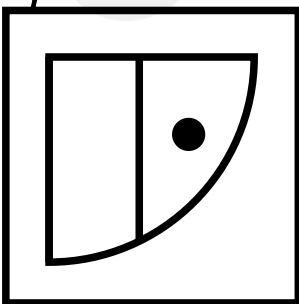

Option 2:

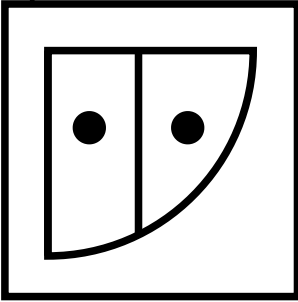

Option 3:

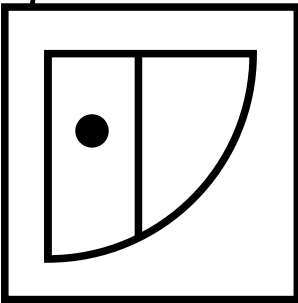

Option 4:

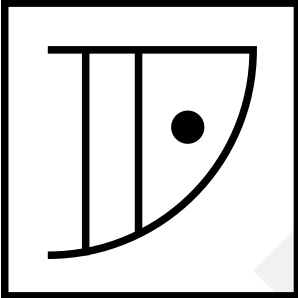

Correct Answer:

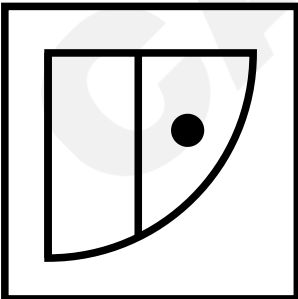

Solution:

On comparing the question figure and all the answer figures, the following figure will combine and make the complete pattern -

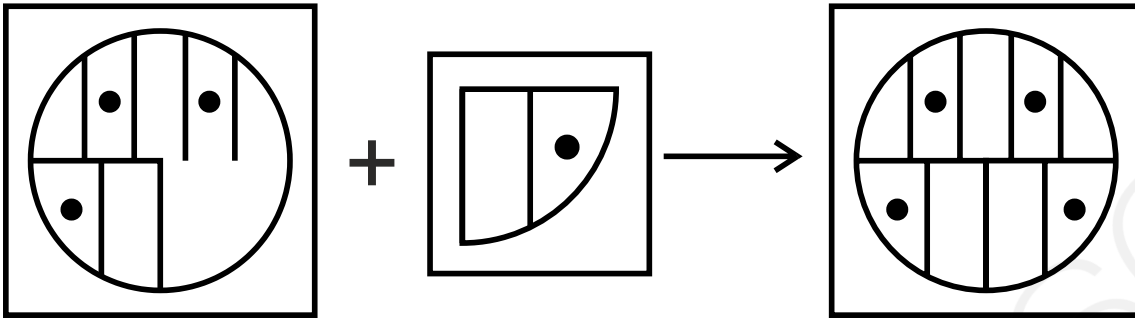

Hence, the **first option** is correct.

Q. 77 **Directions:** Which answer figure will complete the question figure?

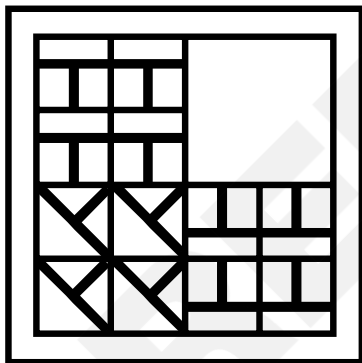

Option 1:

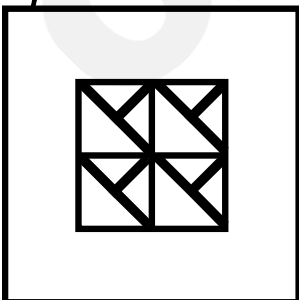

Option 2:

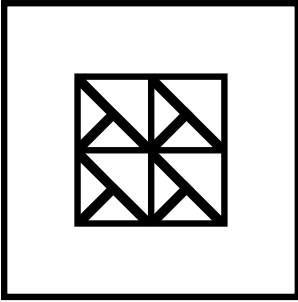

Option 3:

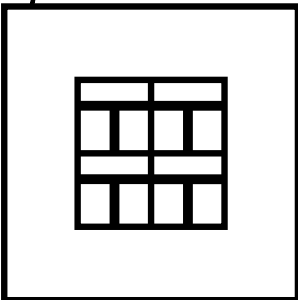

Option 4:

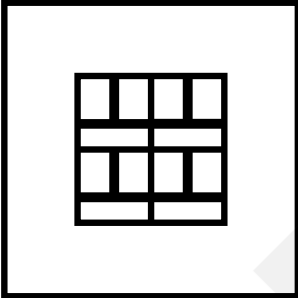

Correct Answer:

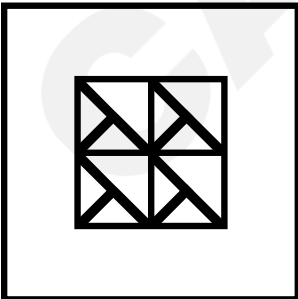

Solution:

On comparing the question figure and all the answer figures, the following figure will combine and make the complete pattern -

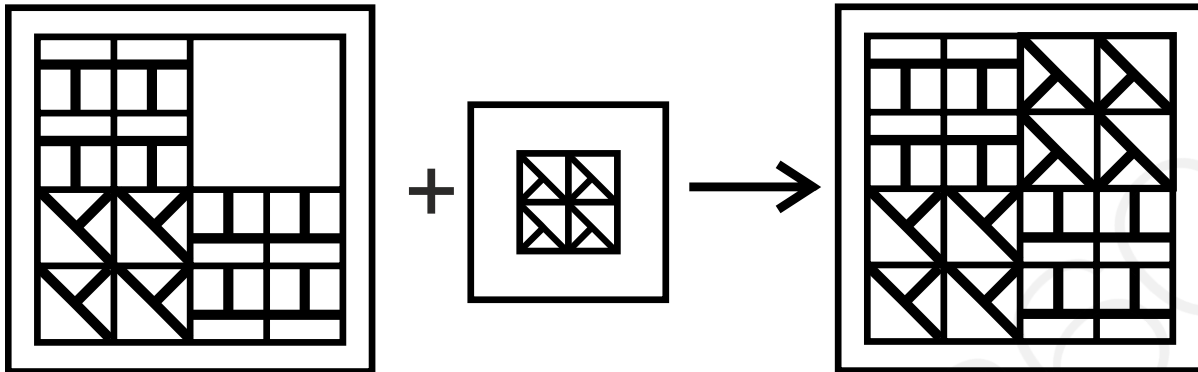

Hence, the **second option** is correct.

Q. 78 **Directions:** Which answer figure will complete the pattern in the question figure?

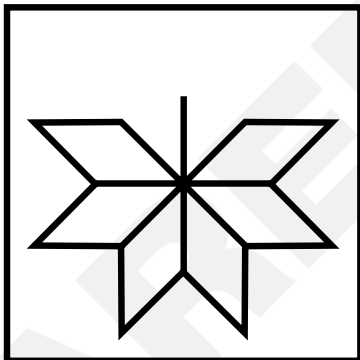

Option 1:

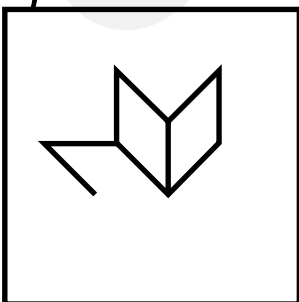

Option 2:

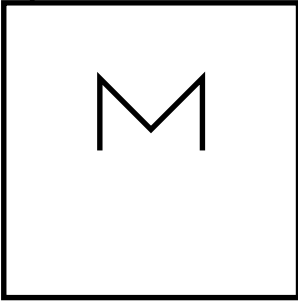

Option 3:

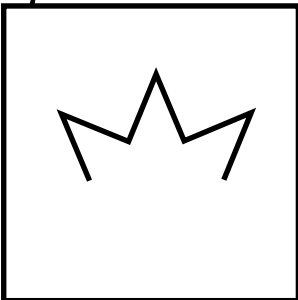

Option 4:

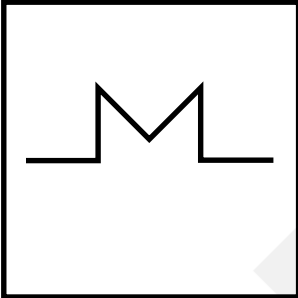

Correct Answer:

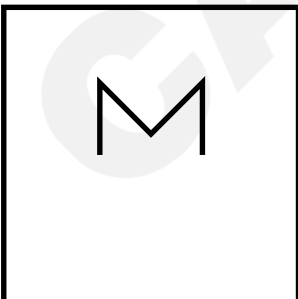

Solution:

On comparing the question figure and all the answer figures, the following figure will combine and make the complete pattern -

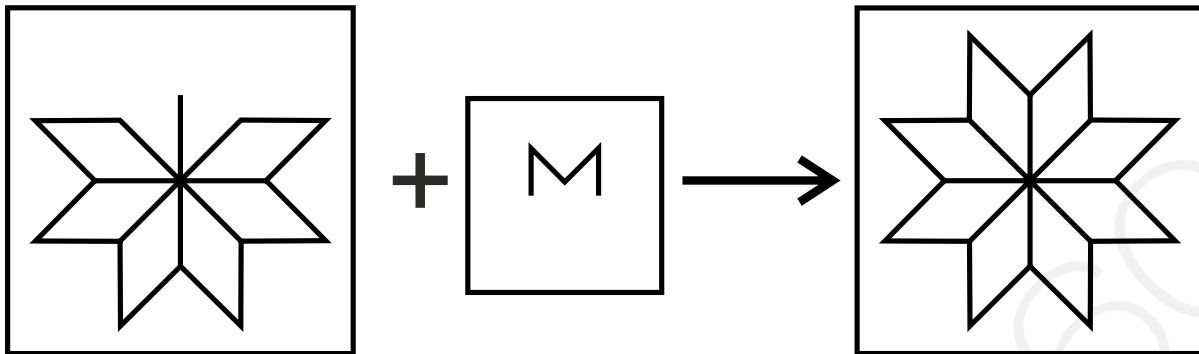

Hence, the **second option** is correct.

Q. 79 **Directions:** Which answer figure will complete the pattern in the question figure?

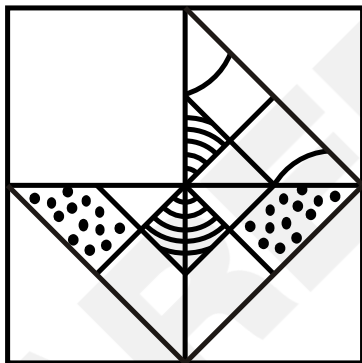

Option 1:

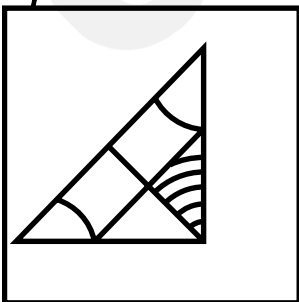

Option 2:

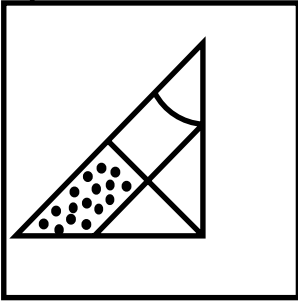

Option 3:

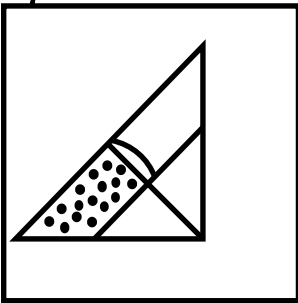

Option 4:

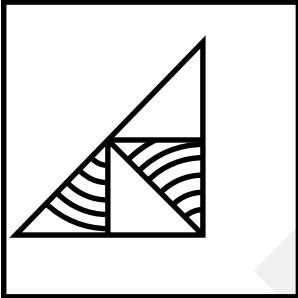

Correct Answer:

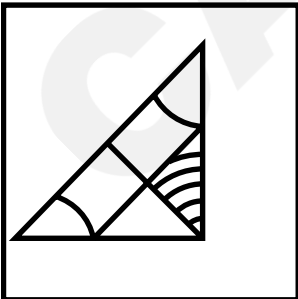

Solution:

On comparing the question figure and all the answer figures, the following figure will combine and make the complete pattern -

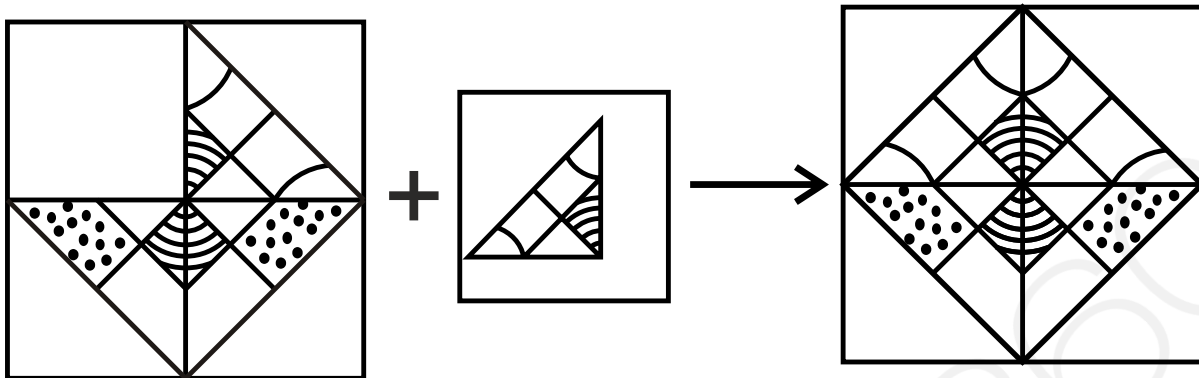

Hence, the **first option** is correct.

- Q. 80** **Directions:** In the following question, which answer figure will complete the pattern in the question figure?

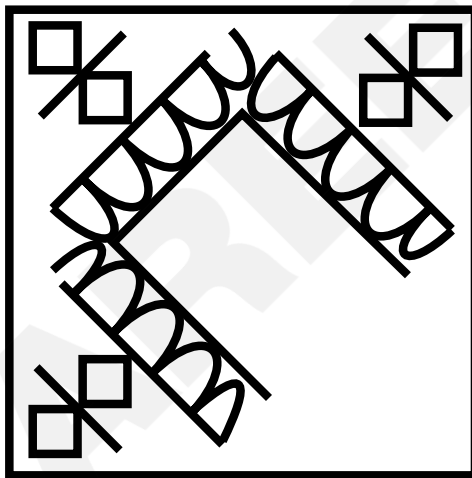

Option 1:

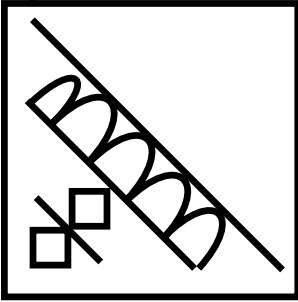

Option 2:

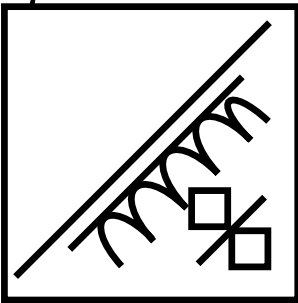

Option 3:

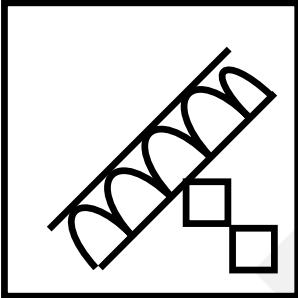

Option 4:

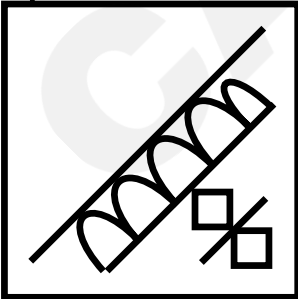

Correct Answer:

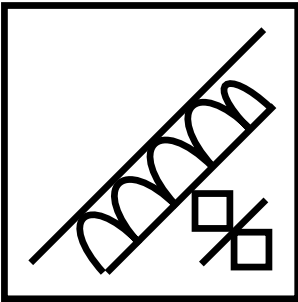

Solution:

On comparing the question figure and all the answer figures, the following figure will combine and make the complete pattern -

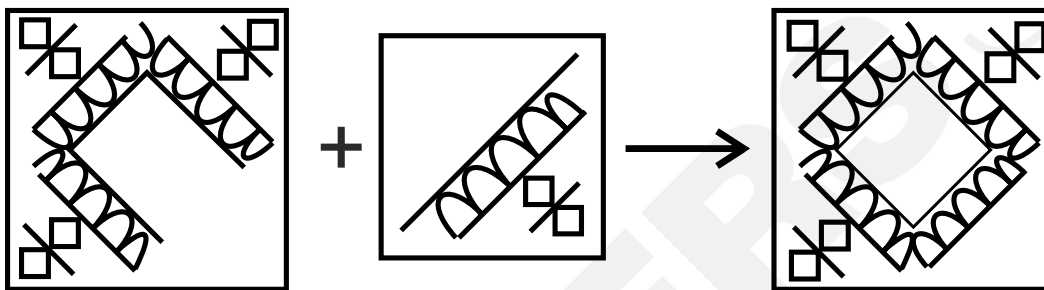

Hence, the **fourth option** is correct.

Q. 81 **Directions:** In the following question, which answer figure will complete the pattern in the question figure?

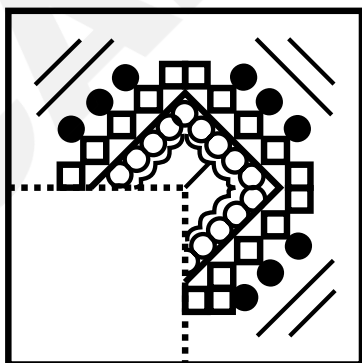

Option 1:

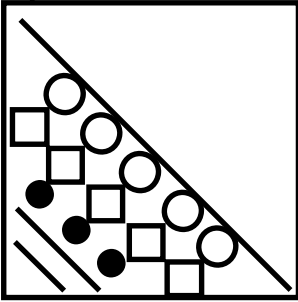

Option 2:

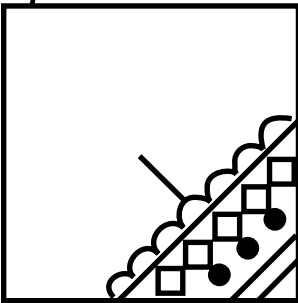

Option 3:

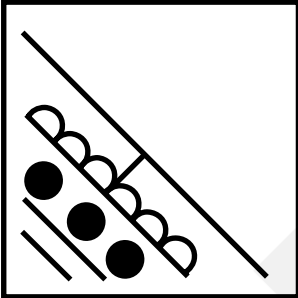

Option 4:

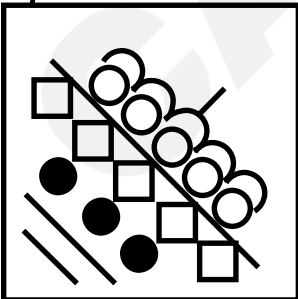

Correct Answer:

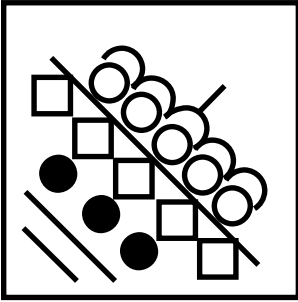

Solution:

On comparing the question figure and all the answer figures, the following figure will combine and make the complete pattern -

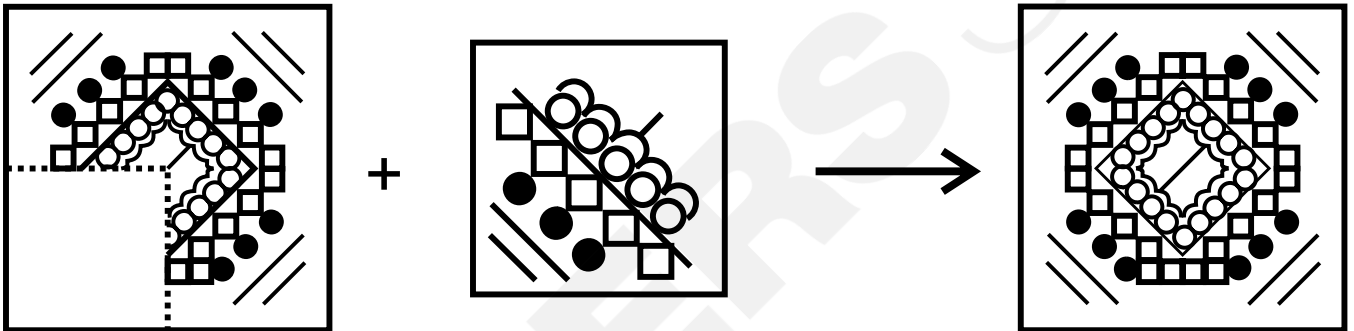

Hence, the **fourth option** is correct.

Q. 82 **Directions:** In the following question, which answer figure will complete the pattern in the question figure?

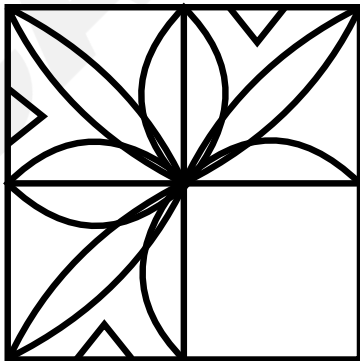

Option 1:

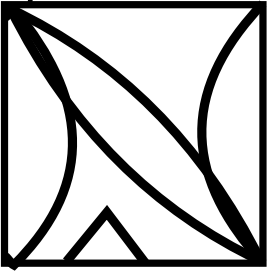

Option 2:

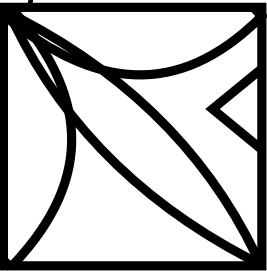

Option 3:

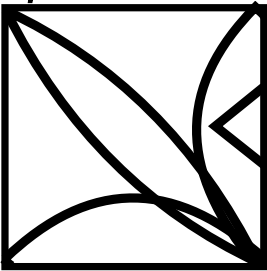

Option 4:

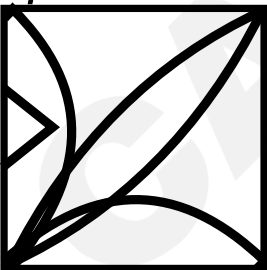

Correct Answer:

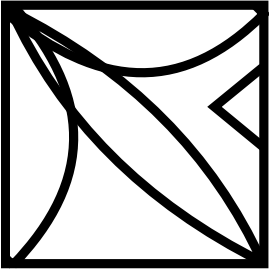

Solution:

On comparing the question figure and all the answer figures, the following figure will combine and make the complete pattern -

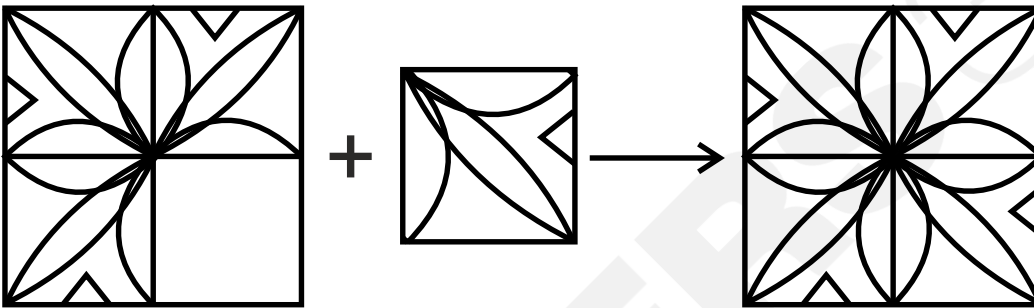

Hence, the **second option** is correct.

Q. 83

Directions: In the following question, which answer figure will complete the pattern in the question figure?

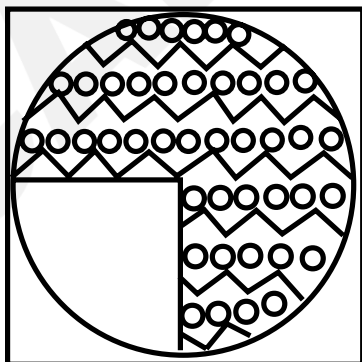

Option 1:

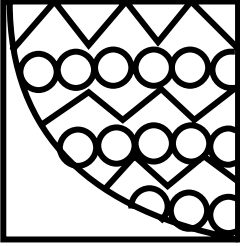

Option 2:

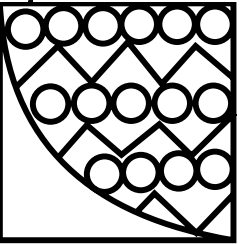

Option 3:

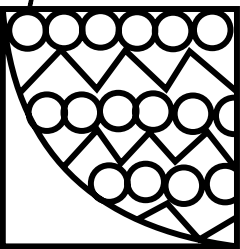

Option 4:

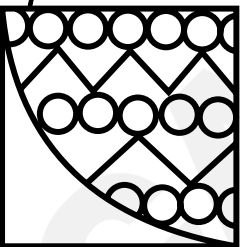

Correct Answer:

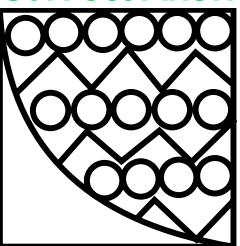

Solution:

On comparing the question figure and all the answer figures, the following figure will combine and make the complete pattern –

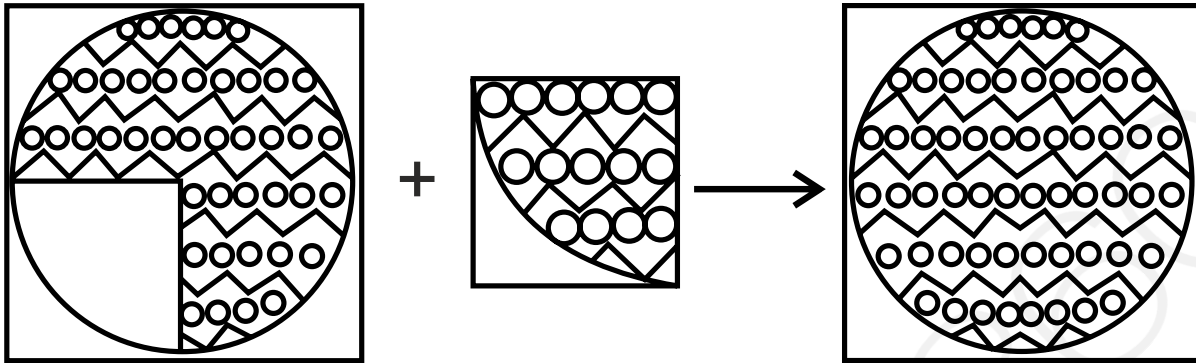

Hence, the **second option** is correct.

Q. 84 **Directions:** Which answer figure will complete the pattern in the question figure?

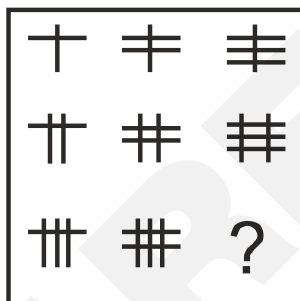

Option 1:

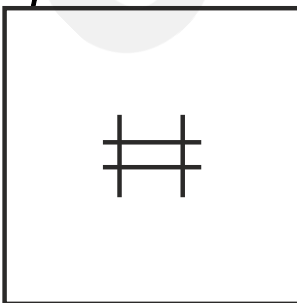

Option 2:

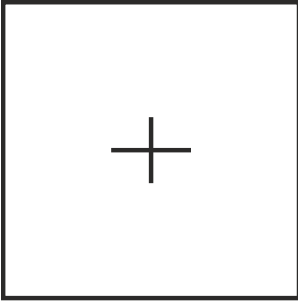

Option 3:

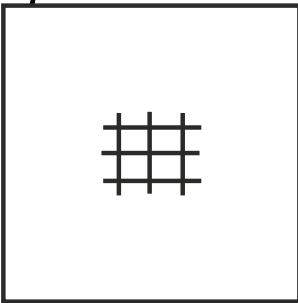

Option 4:



Correct Answer:

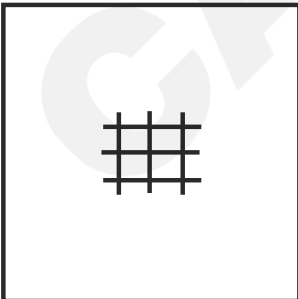

Solution:

According to the question figure –

In row 1: The number of vertical lines is 1 and the number of horizontal lines is increased by 1.

In row 2: The number of vertical lines is 2 and the number of horizontal lines is increased by 1.

In row 3: The number of vertical lines is 1 and the number of horizontal and vertical lines is increased by 1.

On comparing the question figure and all the answer figures, the following figure will combine and make the complete pattern –

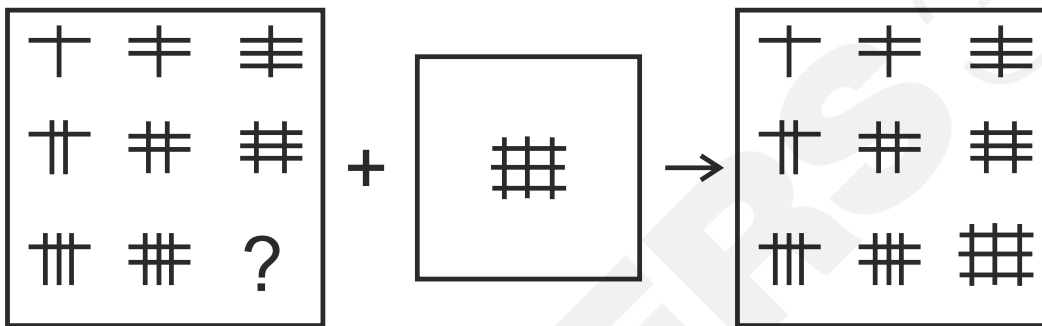

Hence, the **third option** is correct.

- Q. 85** **Directions:** In the following questions, among the four answer figures, which figure can be formed from the cut - pieces given below in the question figure?

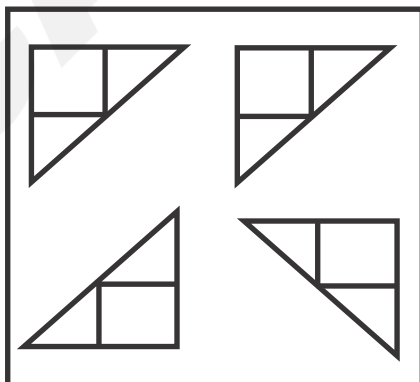

Option 1:

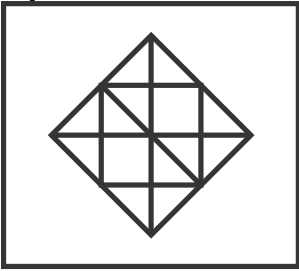

Option 2:

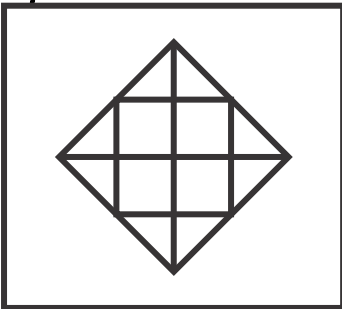

Option 3:

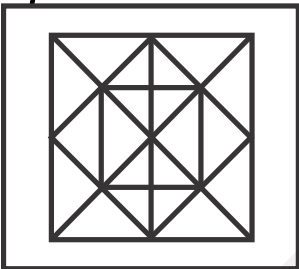

Option 4:

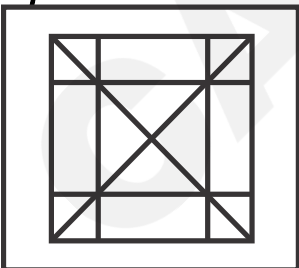

Correct Answer:

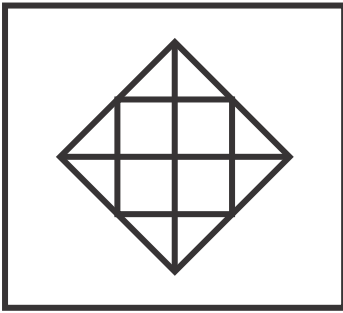

Solution:

The given figure can be numbered as shown below –

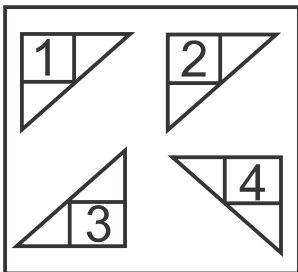

On comparing the question figure and all the answer figures, the following figure has all the pieces –

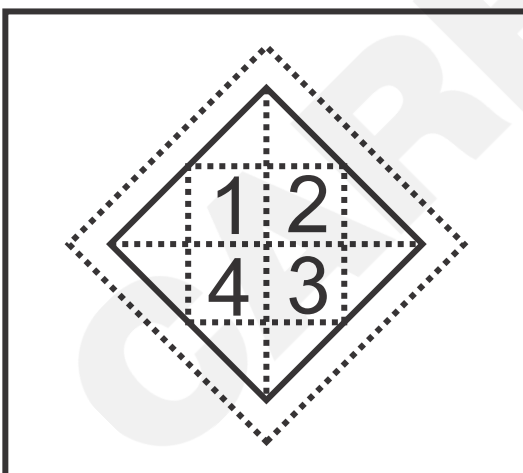

Hence, the **second option** is correct.

- Q. 86** **Directions:** In the following questions, among the four answer figures, which figure can be formed from the cut - pieces given below in the question figure?

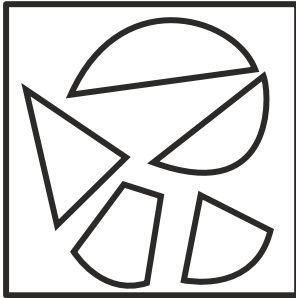

Option 1:

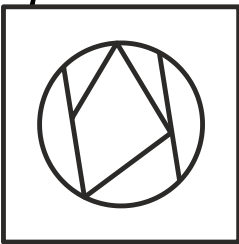

Option 2:

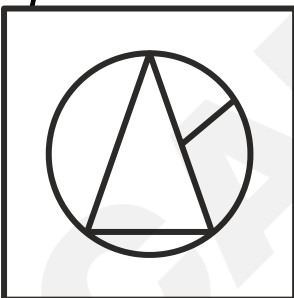

Option 3:

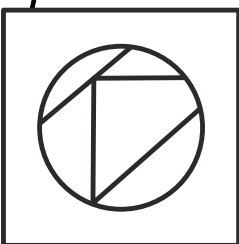

Option 4:

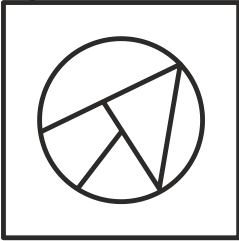

Correct Answer:

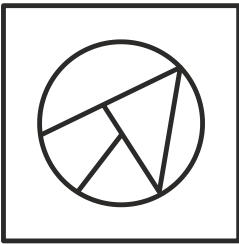

Solution:

The given figure can be numbered as shown below –

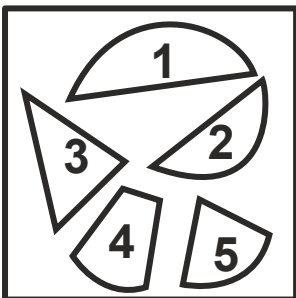

On comparing the question figure and all the option figures, the following figure has all the pieces –

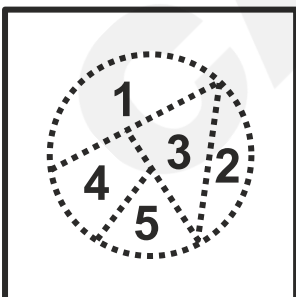

Hence, the **fourth option** is correct.

- Q. 87** **Directions:** Which answer figure will complete the pattern in the question figure?

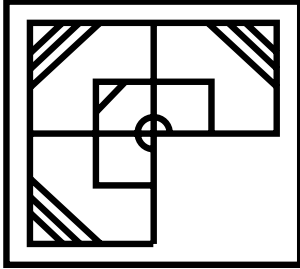

Option 1:

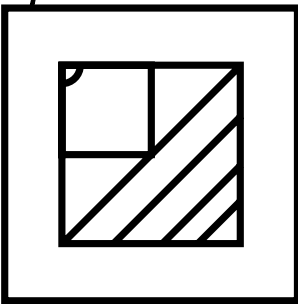

Option 2:

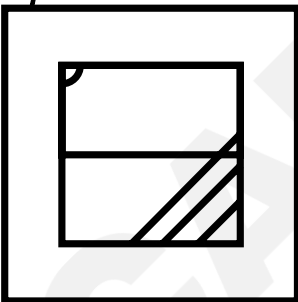

Option 3:

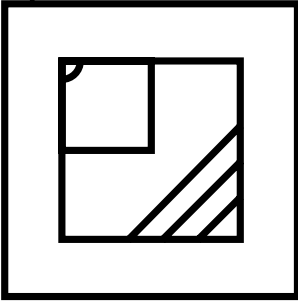

Option 4:

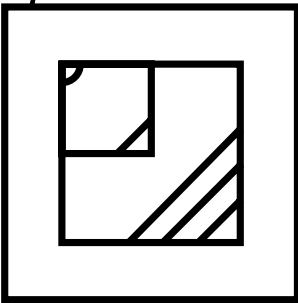

Correct Answer:

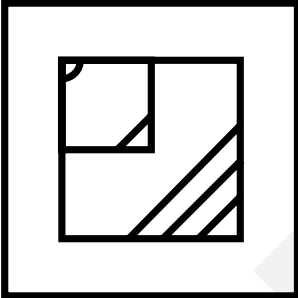

Solution:

On comparing the question figure and all the answer figures, the following figure will combine and make the complete pattern -

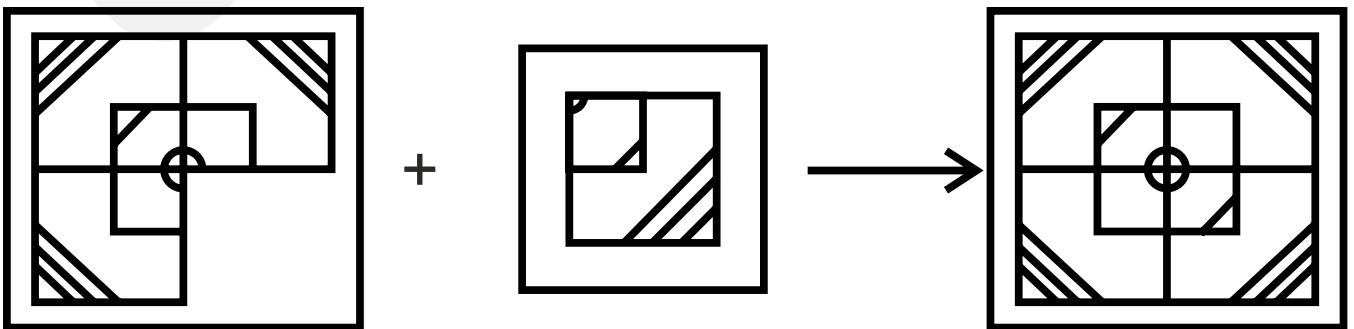

Hence, the **fourth option** is correct.

- Q. 88** **Directions:** Which answer figure will complete the pattern in the question figure?

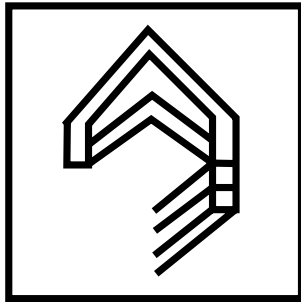

Option 1:

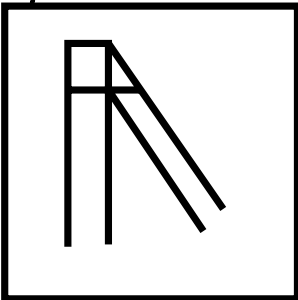

Option 2:

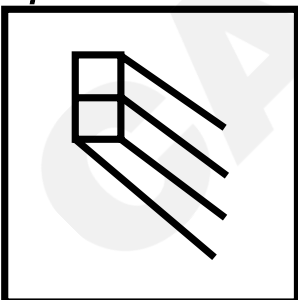

Option 3:

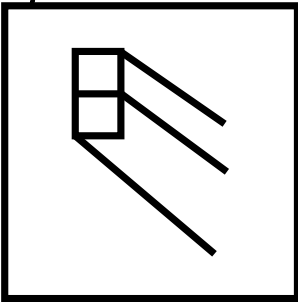

Option 4:

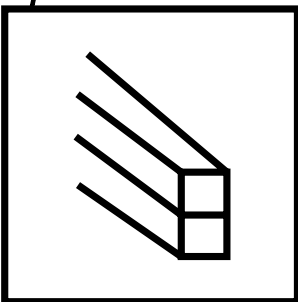

Correct Answer:

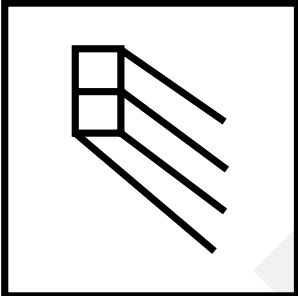

Solution:

On comparing the question figure and all the answer figures, the following figure will combine and make the complete pattern -

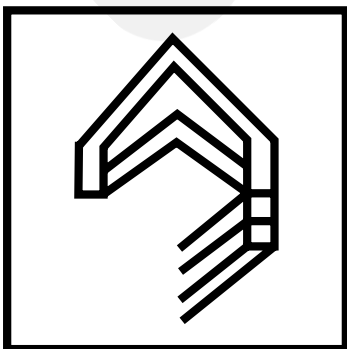

+

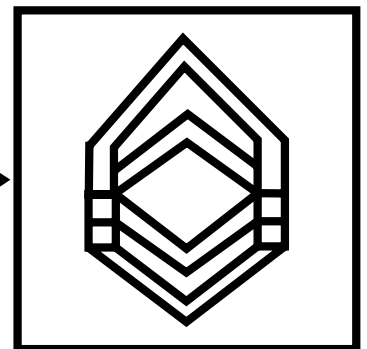
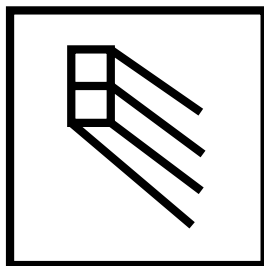

Hence, the **second option** is correct.

- Q. 89** **Directions:** Which answer figure will complete the pattern in the question figure?

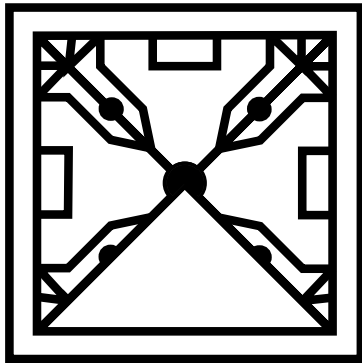

Option 1:

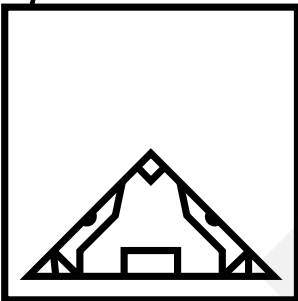

Option 2:

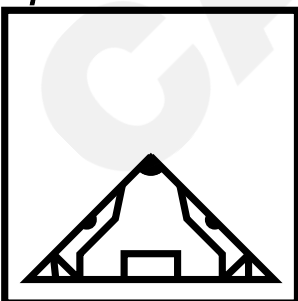

Option 3:

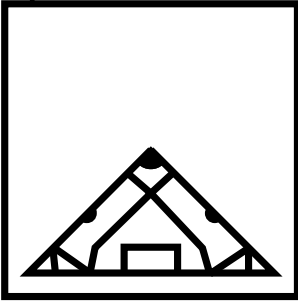

Option 4:

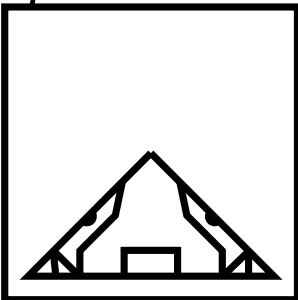

Correct Answer:

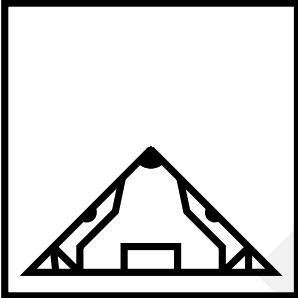

Solution:

On comparing the question figure and all the answer figures, the following figure will combine and make the complete pattern –

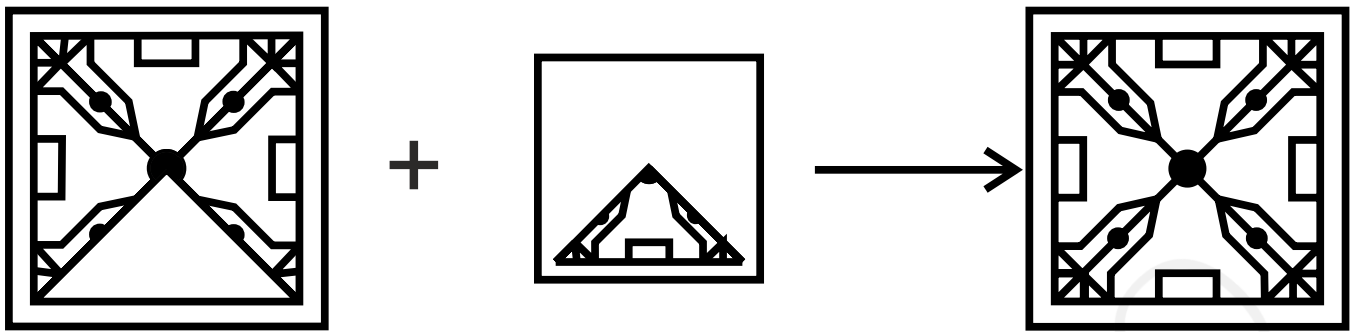

Hence, the **second option** is correct.

Q. 90 **Directions:** Which answer figure will complete the pattern in the question figure?

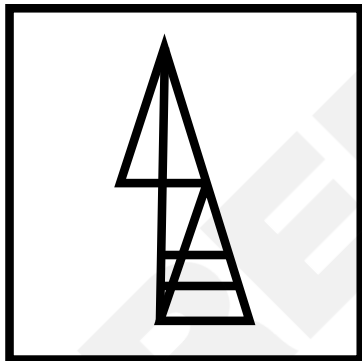

Option 1:

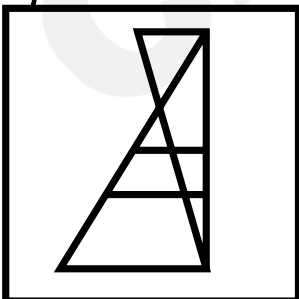

Option 2:

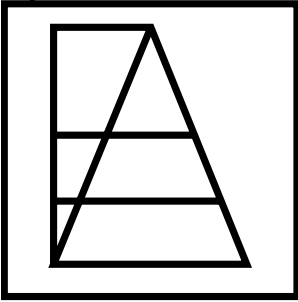

Option 3:

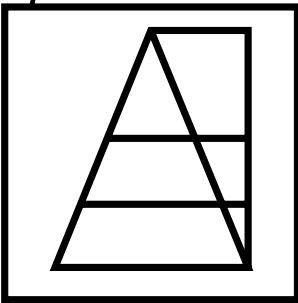

Option 4:

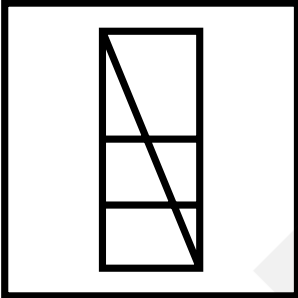

Correct Answer:

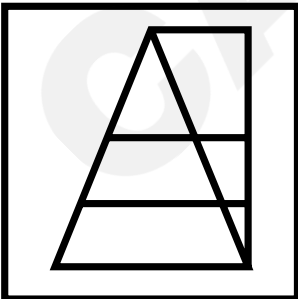

Solution:

On comparing the question figure and all the answer figures, the following figure will combine and make the complete pattern -

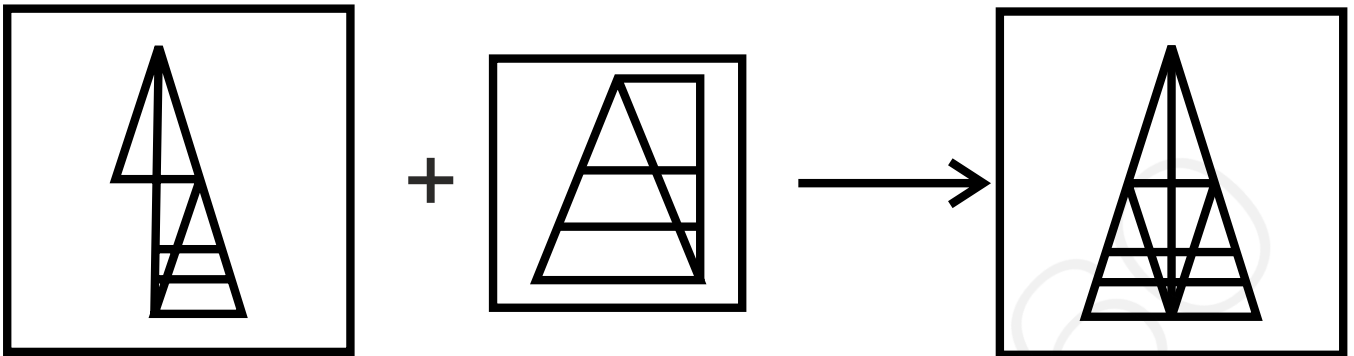

Hence, the **third option** is correct.

- Q. 91** **Directions:** Which answer figure will complete the pattern in the question figure?

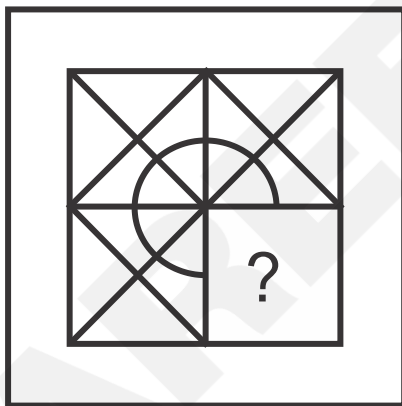

Option 1:

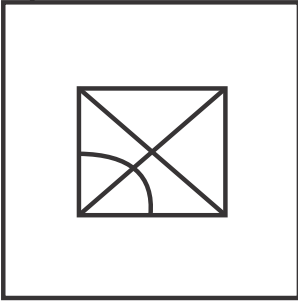

Option 2:

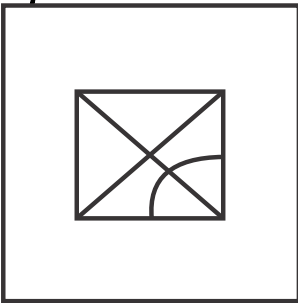

Option 3:

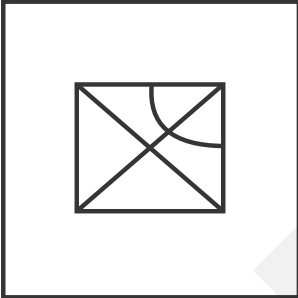

Option 4:

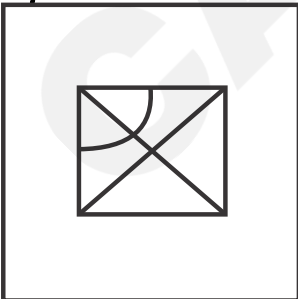

Correct Answer:

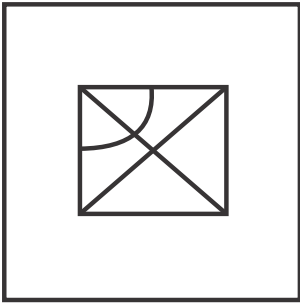

Solution:

On comparing the question figure and all the answer figures, the following figure will combine and make the complete pattern -

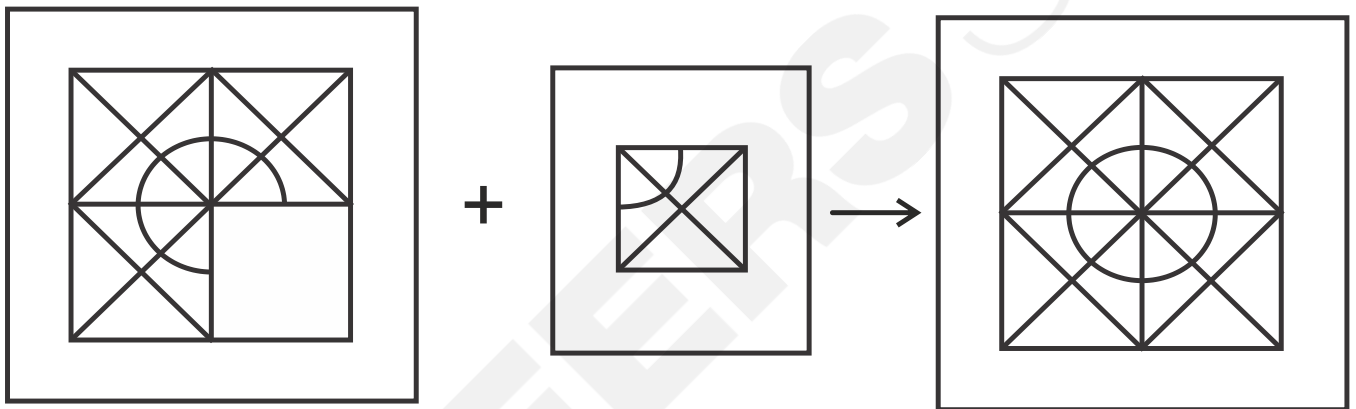

Hence, the **fourth option** is correct.

Q. 92 **Directions:** Which answer figure will complete the pattern in the question figure?

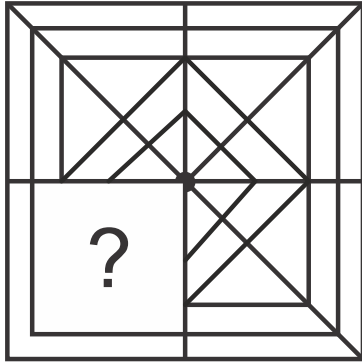

Option 1:

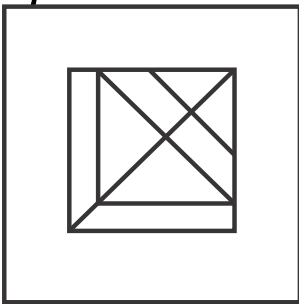

Option 2:

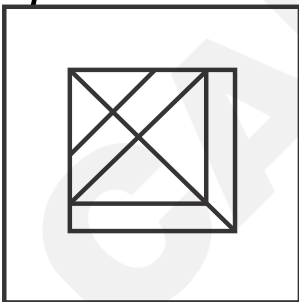

Option 3:

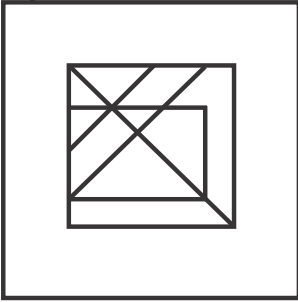

Option 4:

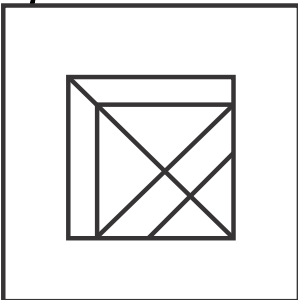

Correct Answer:

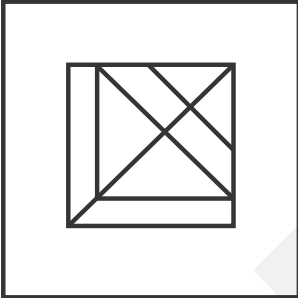

Solution:

On comparing the question figure and all the answer figures, the following figure will combine and make the complete pattern –

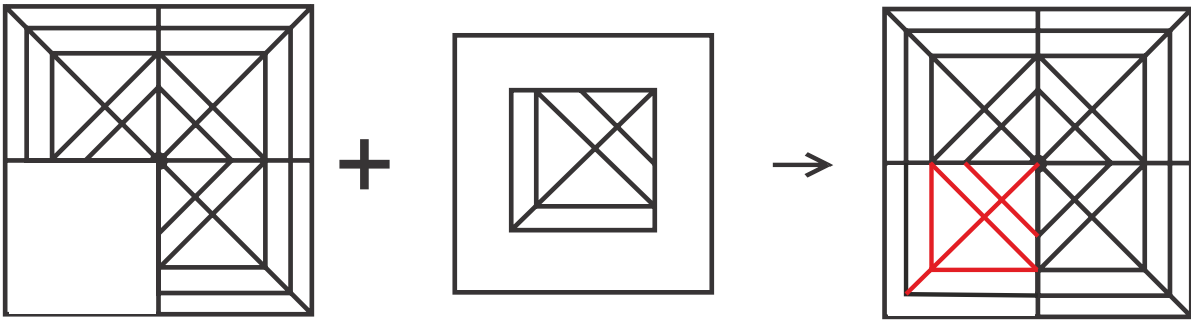

Hence, the **first option** is correct.

Q. 93 **Directions:** Which answer figure will complete the pattern in the question figure?

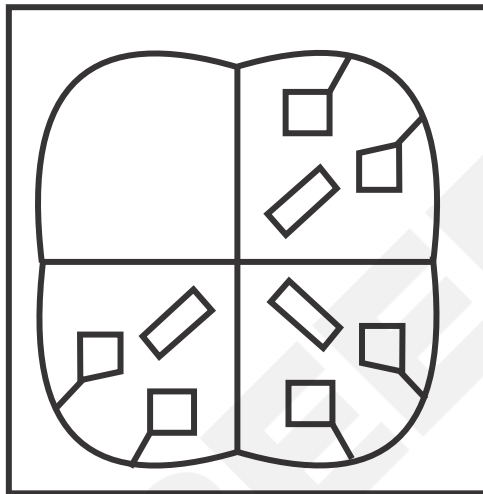

Option 1:

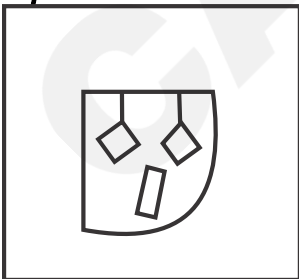

Option 2:

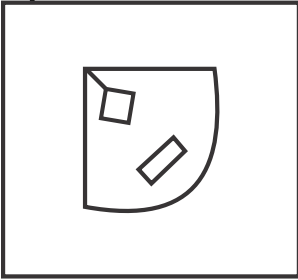

Option 3:

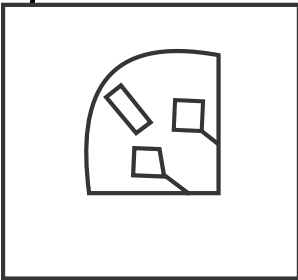

Option 4:

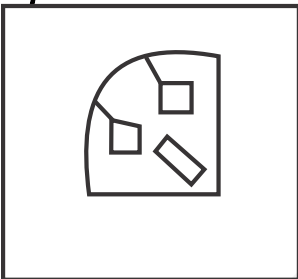

Correct Answer:

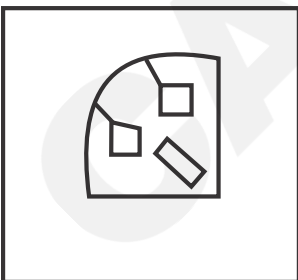

Solution:

On comparing the question figure and all the answer figures, the following figure will combine and make the complete pattern –

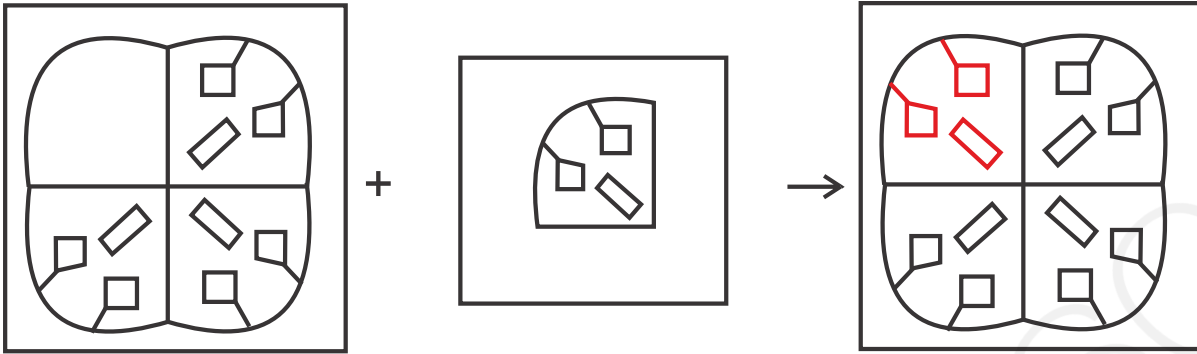

Hence, the **fourth option** is correct.

Q. 94 **Directions:** Which answer figure shall complete the given question figure?

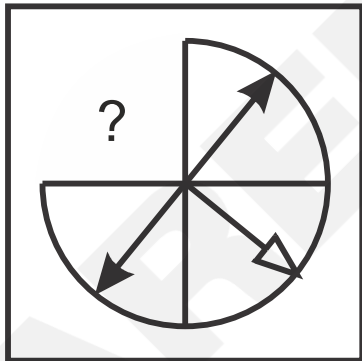

Option 1:

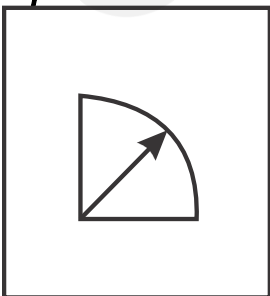

Option 2:

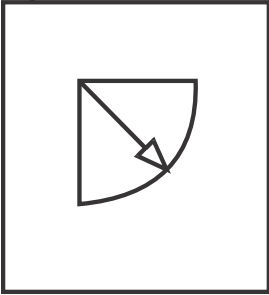

Option 3:

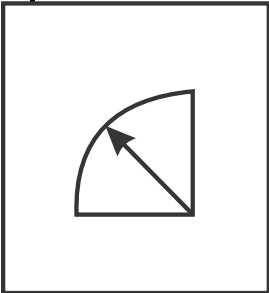

Option 4:

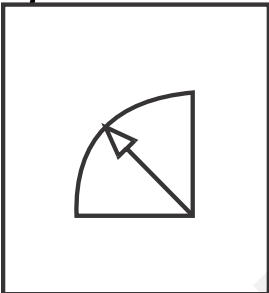

Correct Answer:

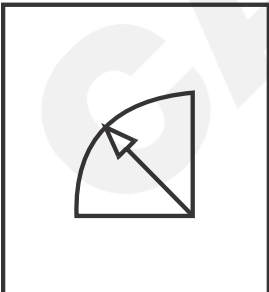

Solution:

On comparing the question figure and all the answer figures, the following figure will combine and make the complete pattern -

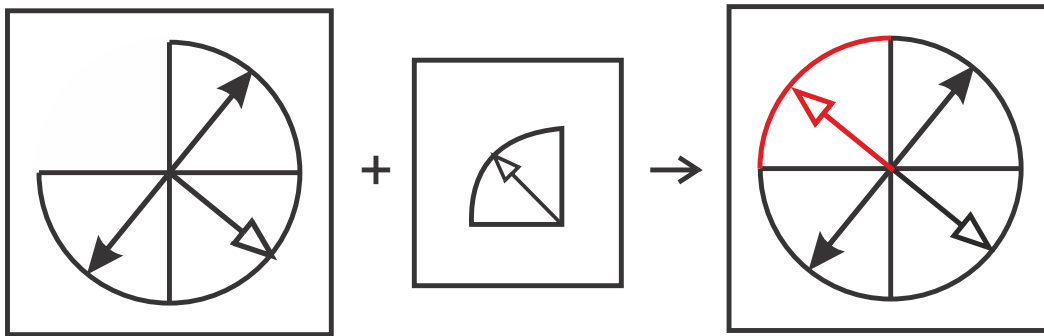

Hence, the **fourth option** is correct.

Q. 95 **Directions:** Which answer figure shall complete the given question figure?

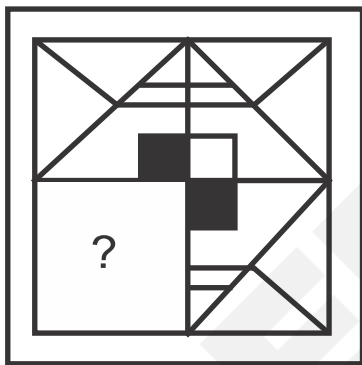

Option 1:

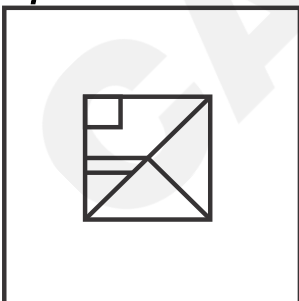

Option 2:

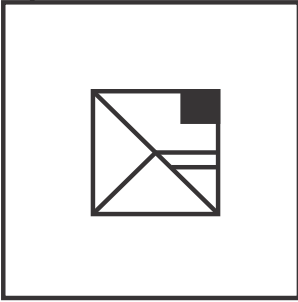

Option 3:

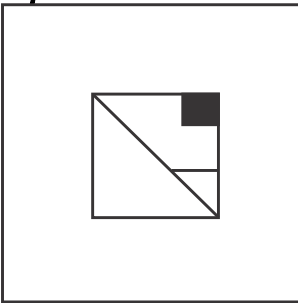

Option 4:



Correct Answer:



Solution:

On comparing the question figure and all the answer figures, the following figure will combine and make the complete pattern -

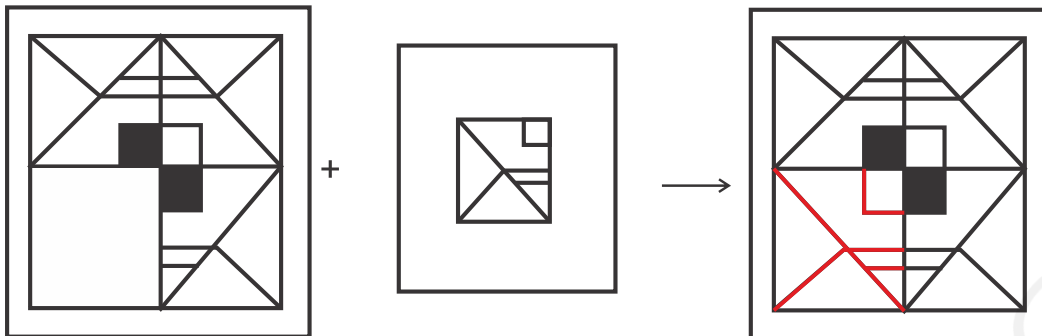

Hence, the **fourth option** is correct.

Q. 96 **Directions:** Which answer figure shall complete the given question figure?

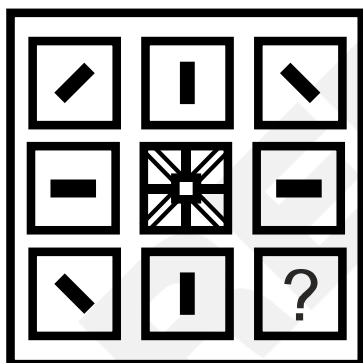

Option 1:

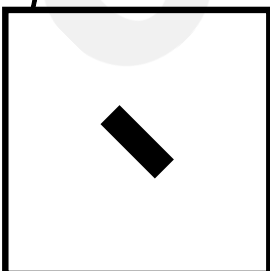

Option 2:

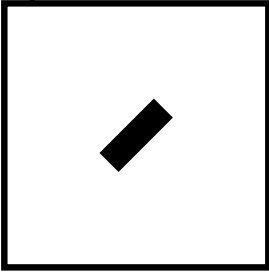

Option 3:

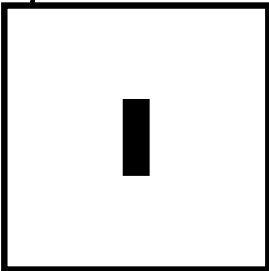

Option 4:

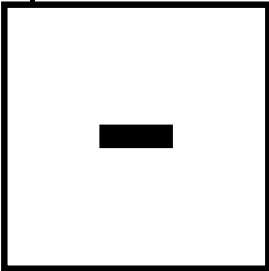

Correct Answer:



Solution:

On comparing the question figure and all the answer figures, the following figure will combine and make the complete pattern -

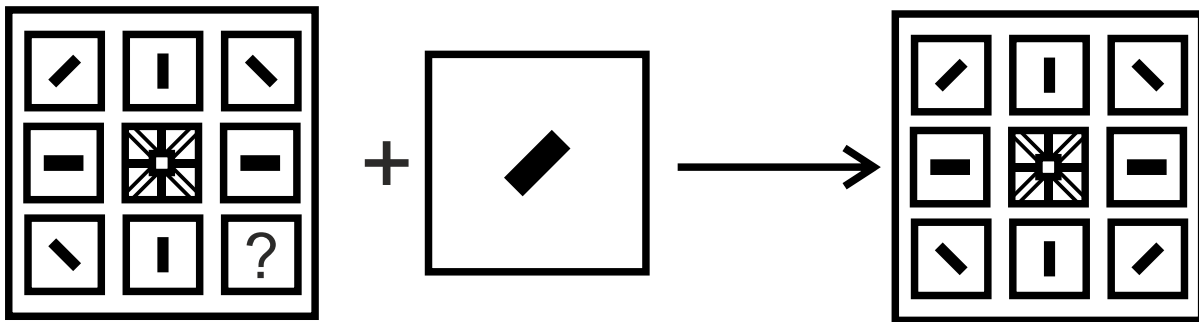

Hence, the **second option** is correct.

Q. 97 **Directions:** Which answer figure shall complete the given question figure?

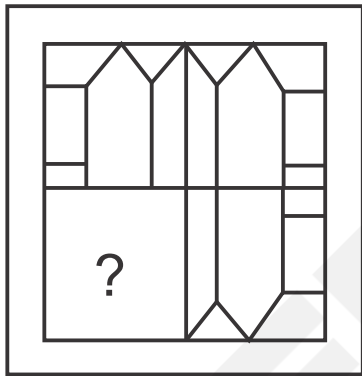

Option 1:

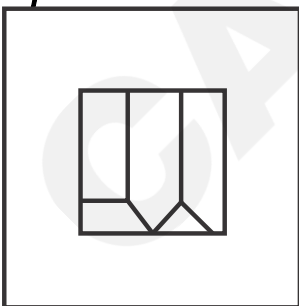

Option 2:

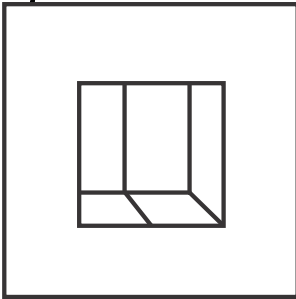

Option 3:

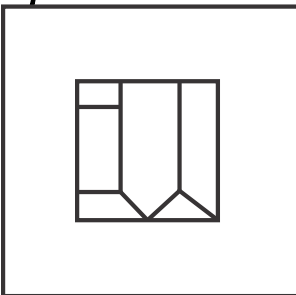

Option 4:

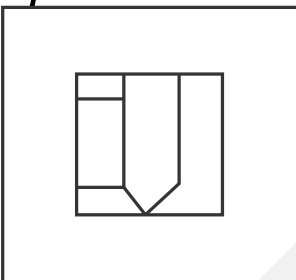

Correct Answer:

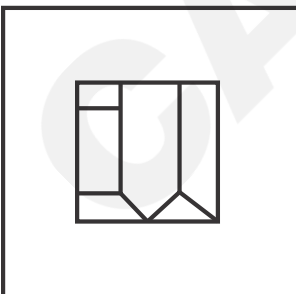

Solution:

On comparing the question figure and all the answer figures, the following figure will combine and make the complete pattern -

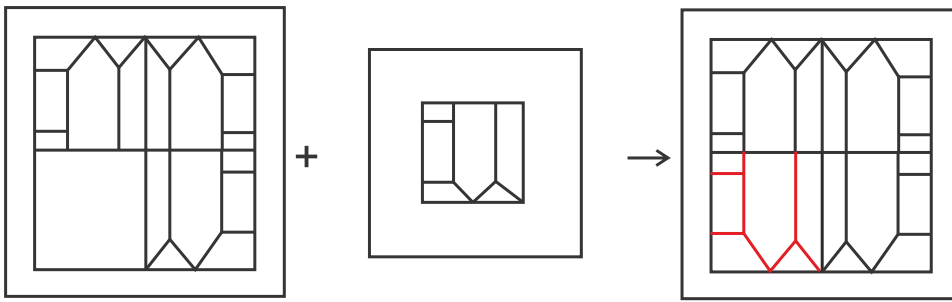

Hence, the **third option** is correct.

Q. 98 **Directions:** Which answer figure will complete the question figure?

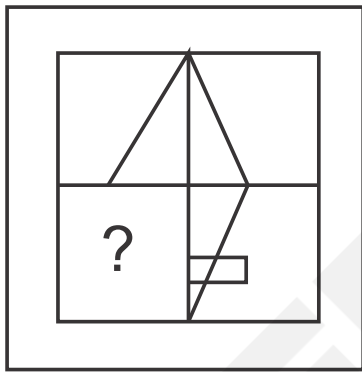

Option 1:



Option 2:

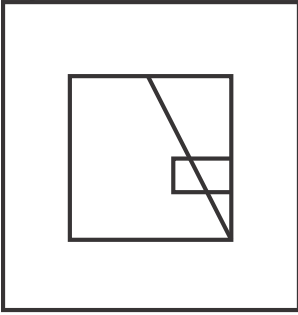

Option 3:

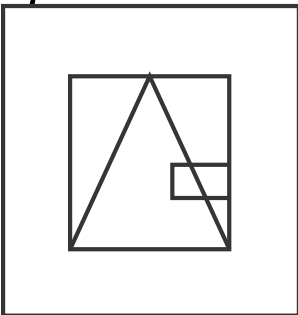

Option 4:

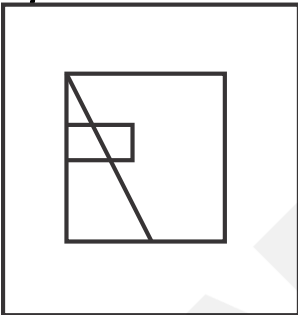

Correct Answer:

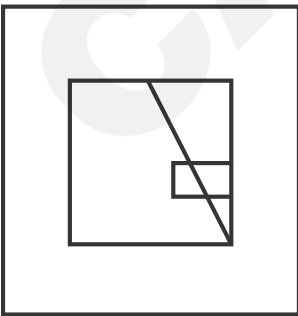

Solution:

On comparing the question figure and all the answer figures, the following figure will combine and make the complete pattern –

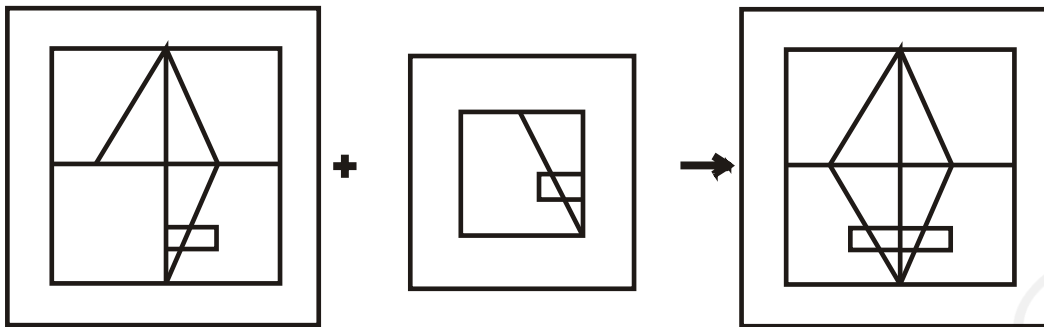

Hence, the **second option** is correct.

Q. 99 **Directions:** Which answer figure will complete the question figure?

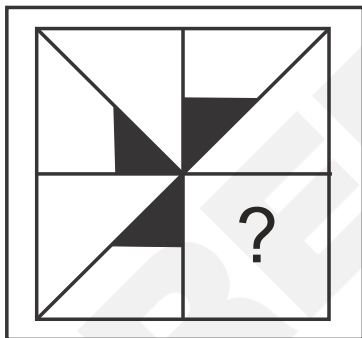

Option 1:

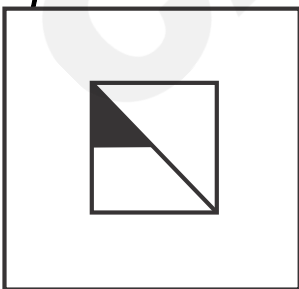

Option 2:

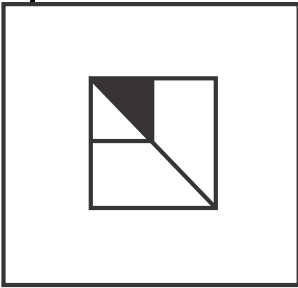

Option 3:

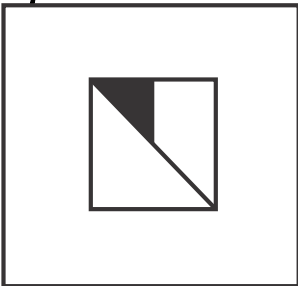

Option 4:

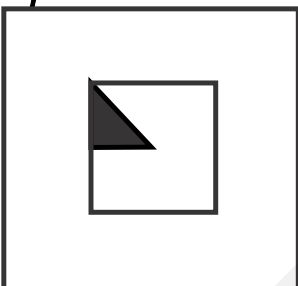

Correct Answer:



Solution:

On comparing the question figure and all the answer figures, the following figure will combine and make the complete pattern –

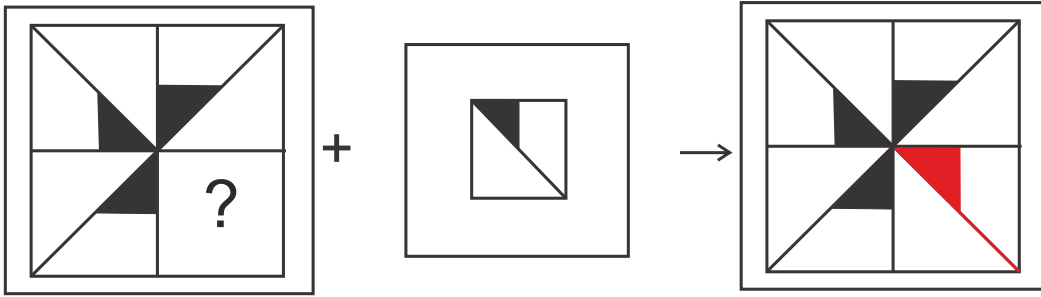

Hence, the **third option** is correct.

**Q.
100**

Directions: Choose the correct figure to complete the figure.

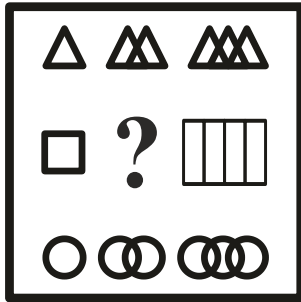

Option 1:



Option 2:

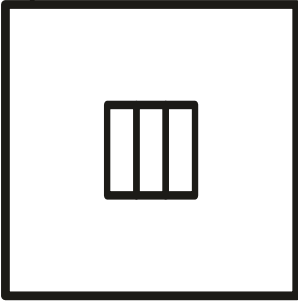

Option 3:

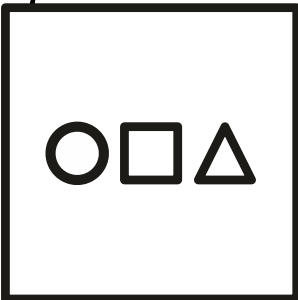

Option 4:

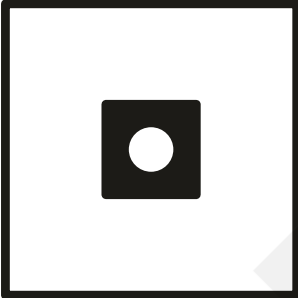

Correct Answer:

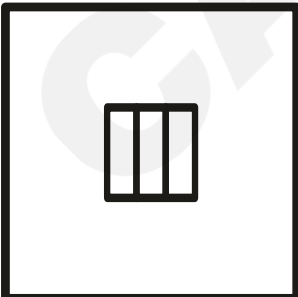

Solution:

Here the pattern is as follows –

1. In the first row number of triangles increases by one.
 2. In the second row number of squares increases by one.
 3. In the third row number of circles increases by one.
- So, the figure in the third option will complete the figure –

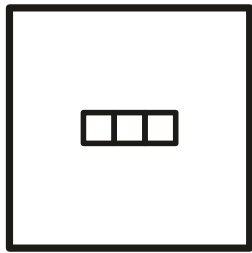

↑
Option Figure

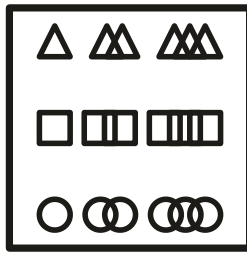

↑
Matrix

Hence, the **third option** is correct.

Q.
101

Directions: Among the four answer figures, which one can be formed from the cut pieces given below in the question figure?



Option 1:

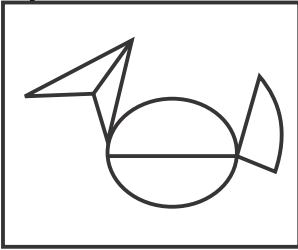

Option 2:

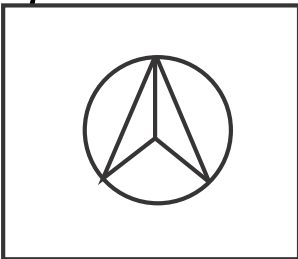

Option 3:

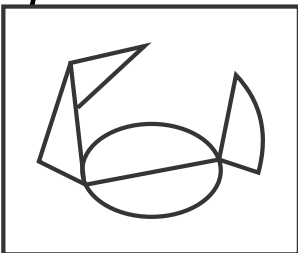

Option 4:

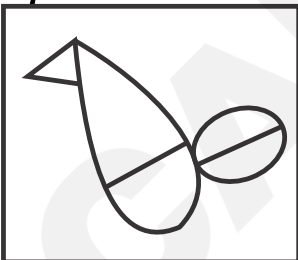

Correct Answer:

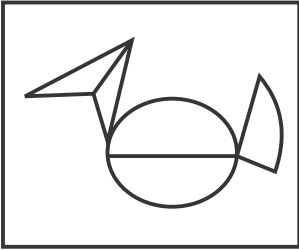

Solution:

The various parts of the figure can be numbered as follows –

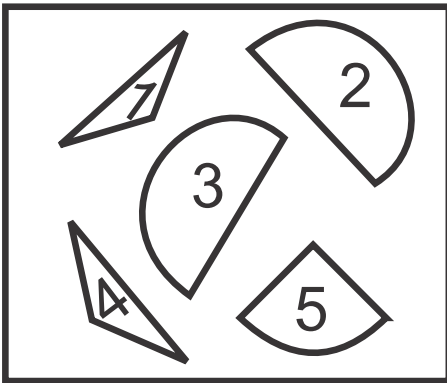

The parts can be arranged in the following manner –

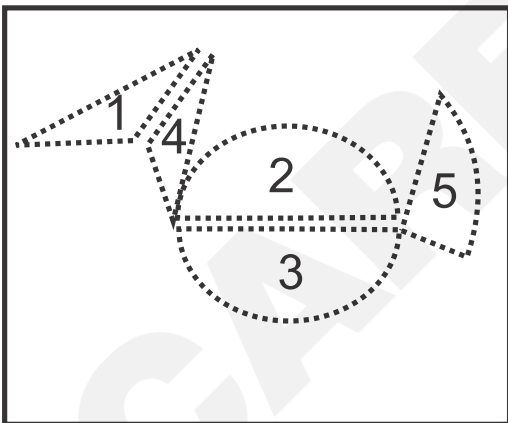

Hence, the **first option** is correct.

Q.
102

Directions: Select the figure from the options that can replace the question mark (?) and complete the pattern.



Option 1:



Option 2:

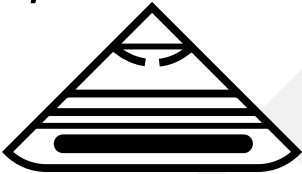

Option 3:



Option 4:

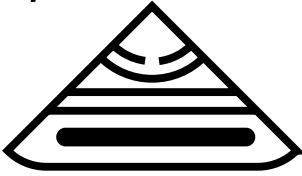

Correct Answer:

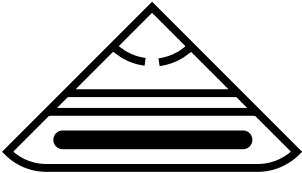

Solution:

On comparing the question figure and all the answer figures, the following figure will combine and make the complete pattern -



Hence, the **third option** is correct.

Q.
103

Directions: Select the figure from the options that can replace the question mark (?) and complete the pattern.

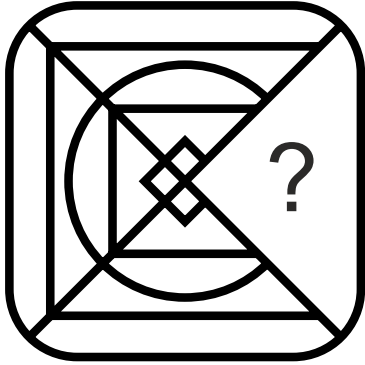

Option 1:

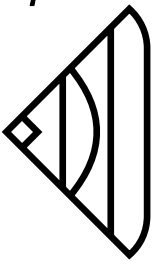

Option 2:

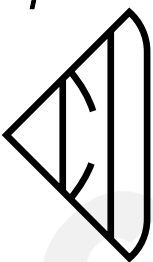

Option 3:

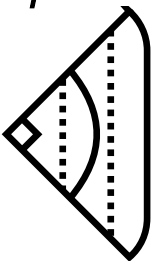

Option 4:

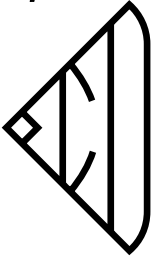

Correct Answer:

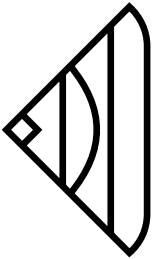

Solution:

On comparing the question figure and all the answer figures, the following figure will combine and make the complete pattern -

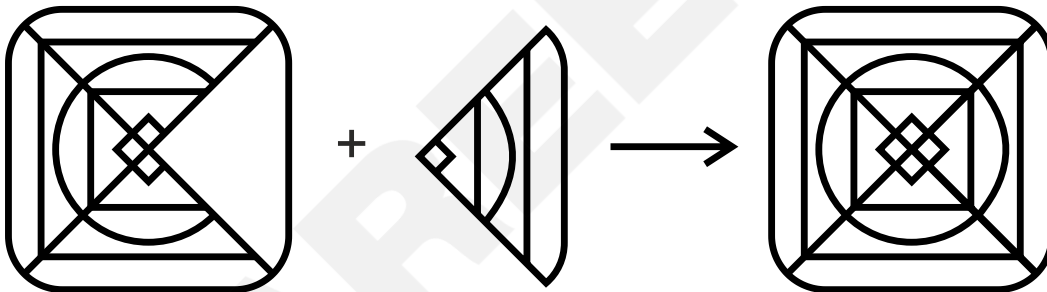

Hence, the **first option** is correct.

Q.
104

Directions: Select the figure from the options that can replace the question mark (?) and complete the given pattern.

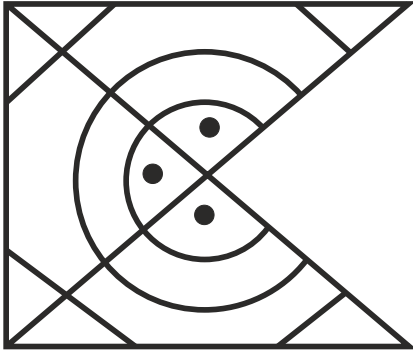

Option 1:

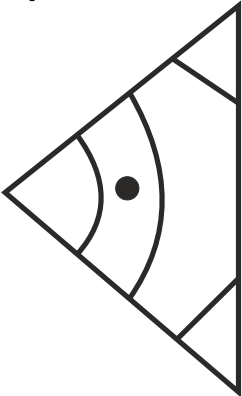

Option 2:

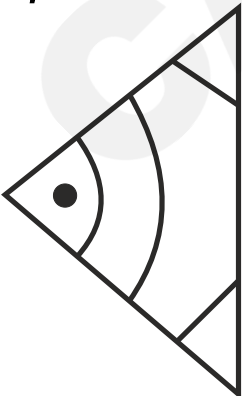

Option 3:

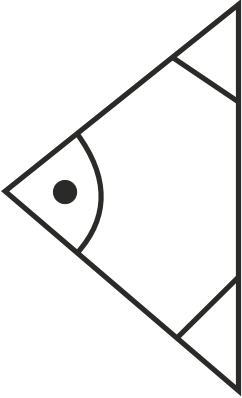

Option 4:

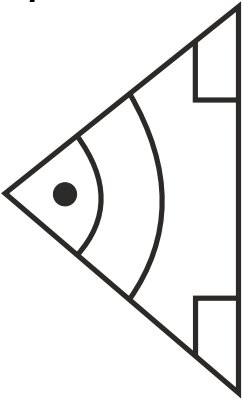

Correct Answer:

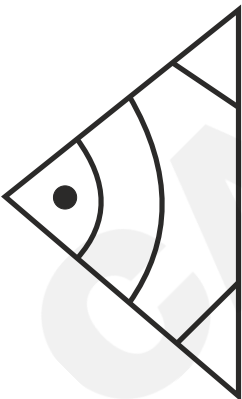

Solution:

On comparing the question figure and all the answer figures, the following figure will combine and make the complete pattern -

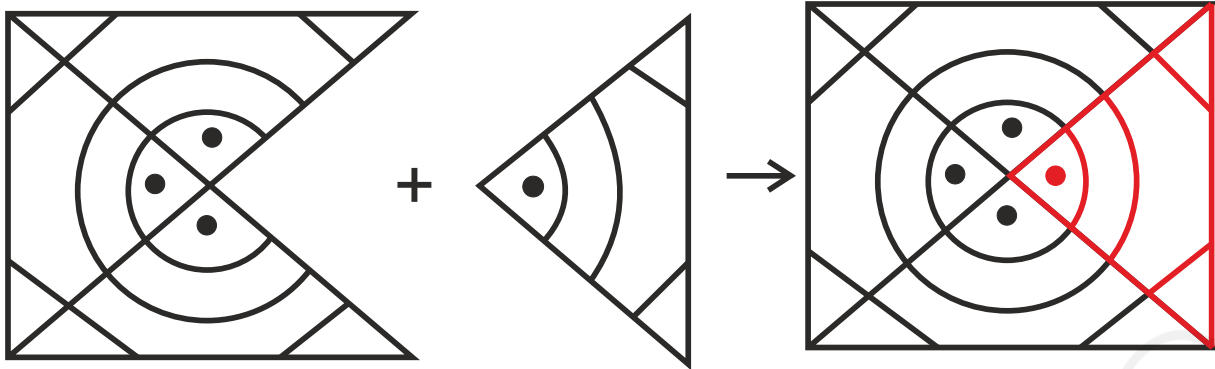

Hence, the **second option** is correct.

**Q.
105**

Directions: Select the figure from the options that can replace the question mark (?) and complete the given pattern.

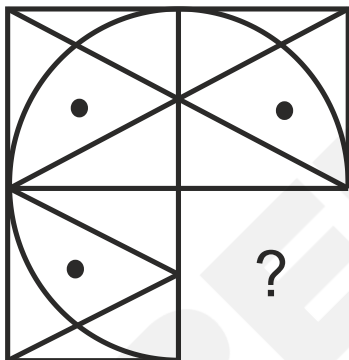

Option 1:

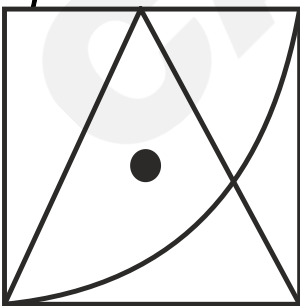

Option 2:

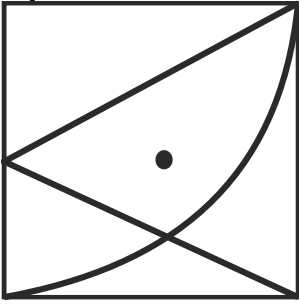

Option 3:

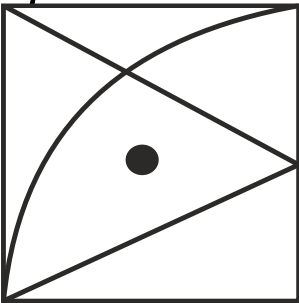

Option 4:

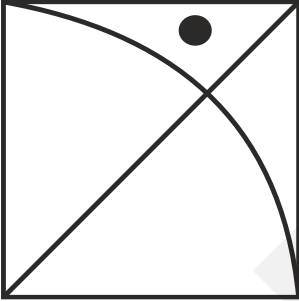

Correct Answer:

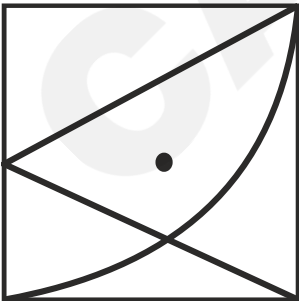

Solution:

On comparing the question figure and all the answer figures, the following figure will combine and make the complete pattern -

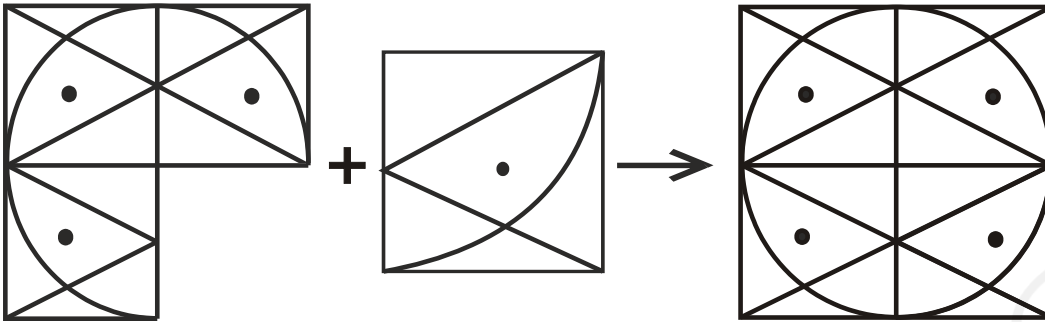

Hence, the **second option** is correct.

Q.
106

Directions: Which answer figure will complete the pattern in the question figure?

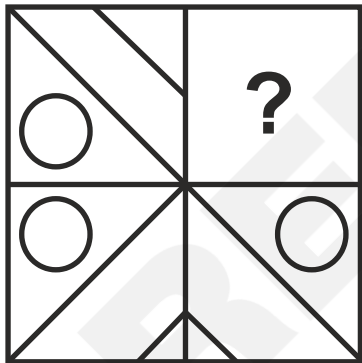

Option 1:

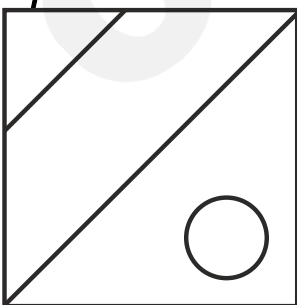

Option 2:

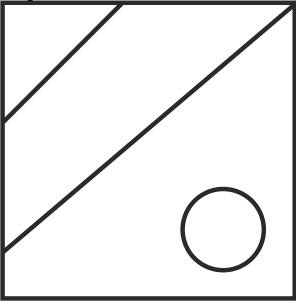

Option 3:

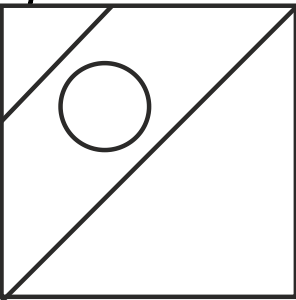

Option 4:

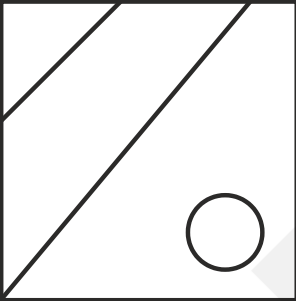

Correct Answer:

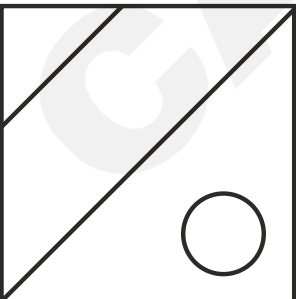

Solution:

On comparing the question figure and all the answer figures, the following figure will combine and make the complete pattern –

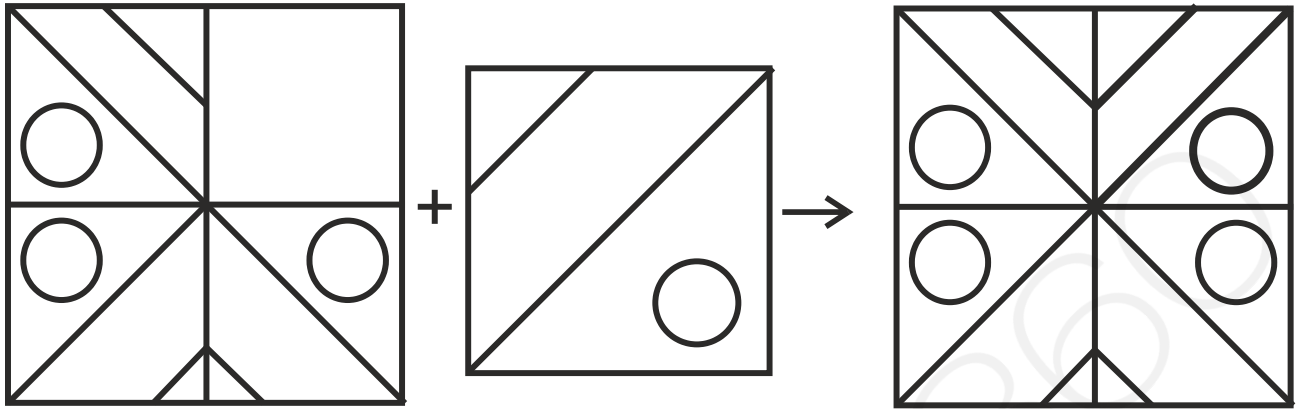

Hence, the **first option** is correct.

**Q.
107**

Directions: Select the option figure that will replace the question mark (?) in the figure given below to complete the pattern. (Rotation is not allowed.)

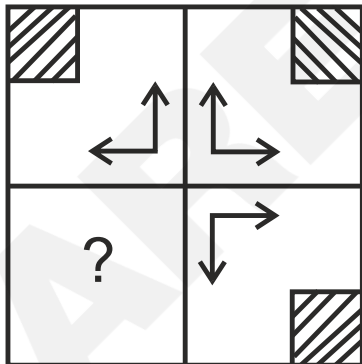

Option 1:

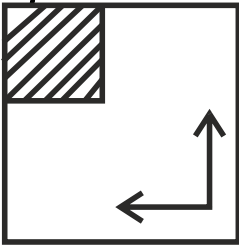

Option 2:

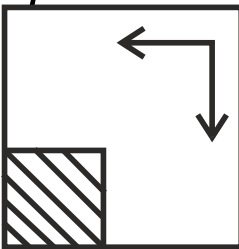

Option 3:

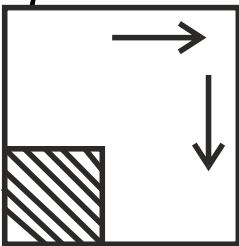

Option 4:

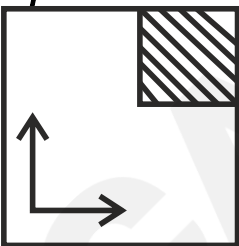

Correct Answer:

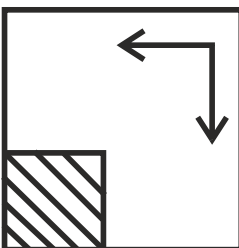

Solution:

On comparing the question figure and all the option figures, the following figure will combine and make the complete pattern -

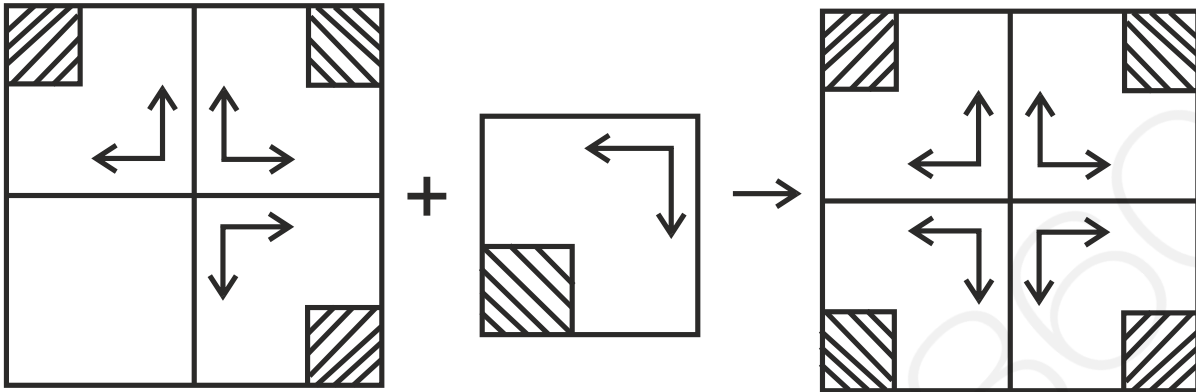

Hence, the **second option** is correct.

**Q.
108**

Directions: Which answer figure will complete the pattern in the question figure?

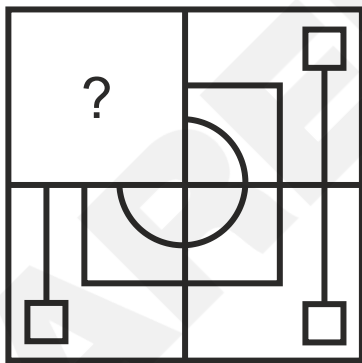

Option 1:

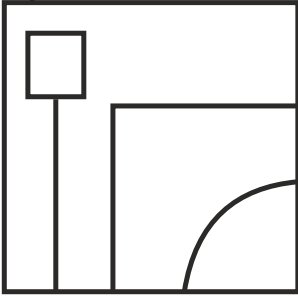

Option 2:

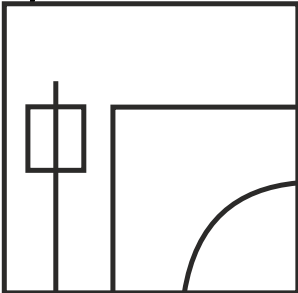

Option 3:

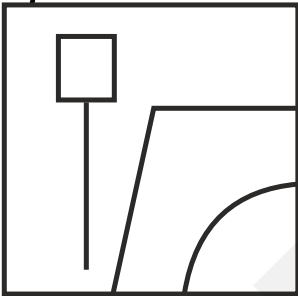

Option 4:

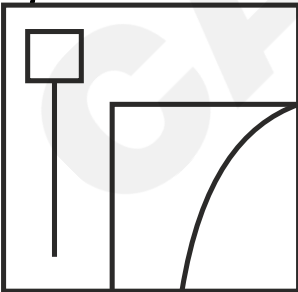

Correct Answer:

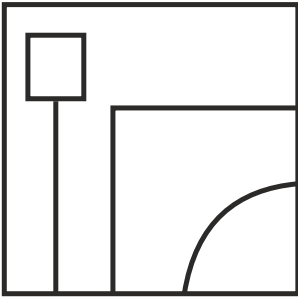

Solution:

On comparing the question figure and all the answer figures, the following figure will combine and make the complete pattern –

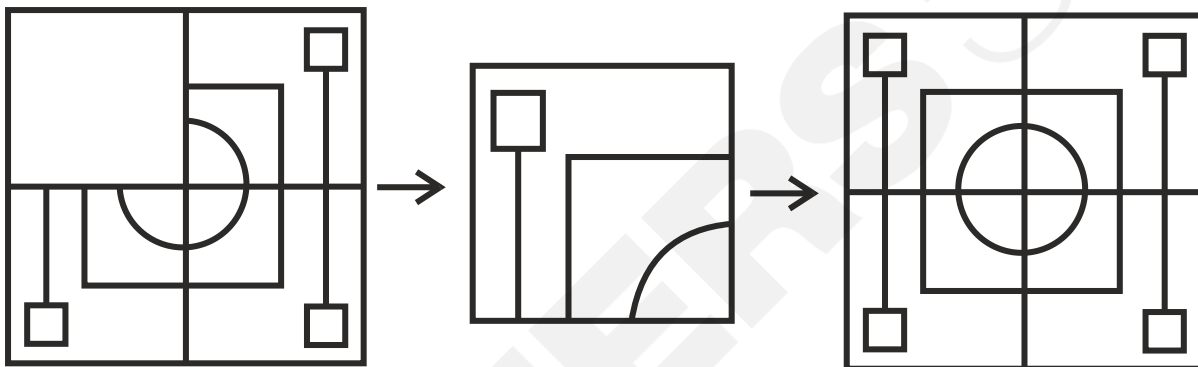

Hence, the **first option** is correct.

**Q.
109**

Directions: Which answer figure will complete the pattern in the question figure?

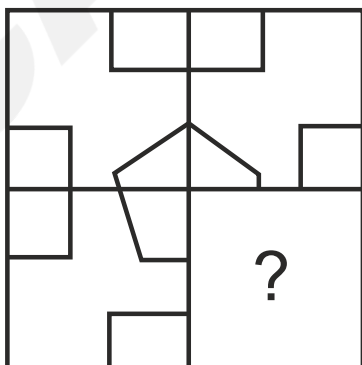

Option 1:

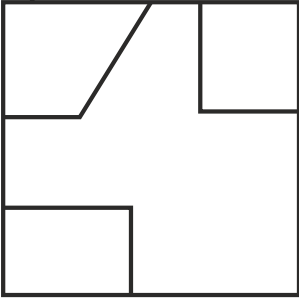

Option 2:

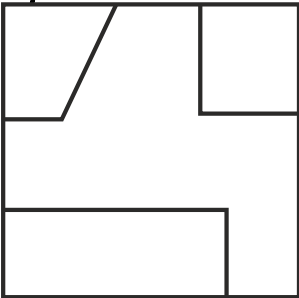

Option 3:

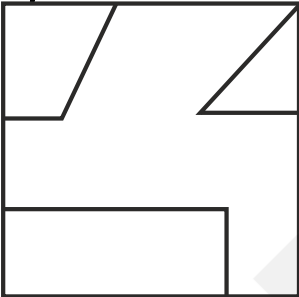

Option 4:

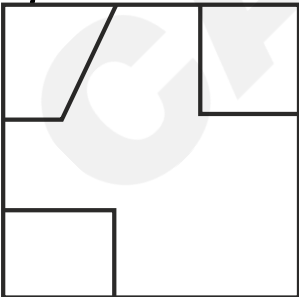

Correct Answer:

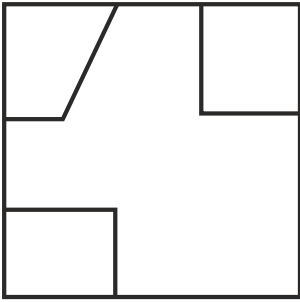

Solution:

On comparing the question figure and all the option figures, the following figure will combine and make the complete pattern –

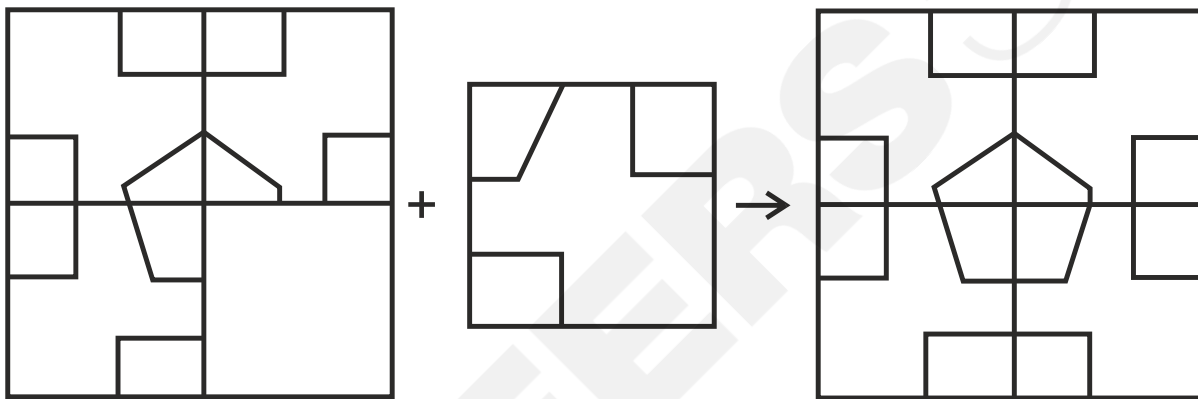

Hence, the **fourth option** is correct.

Q.
110

Directions: Which answer figure will complete the pattern in the question figure?

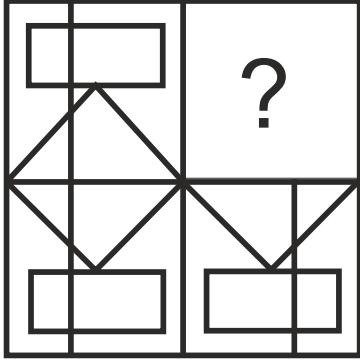

Option 1:

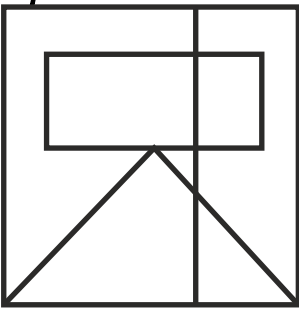

Option 2:

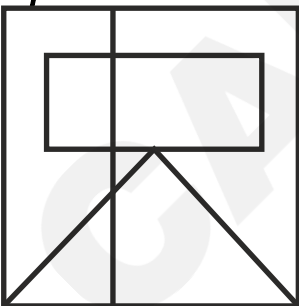

Option 3:

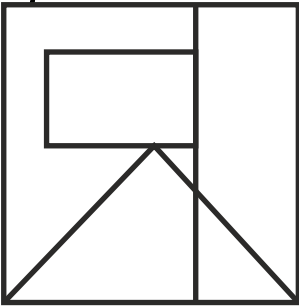

Option 4:

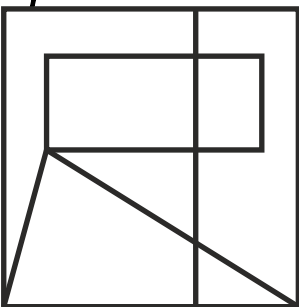

Correct Answer:

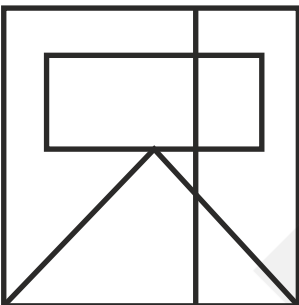

Solution:

On comparing the question figure and all the option figures, the following figure will combine and make the complete pattern -

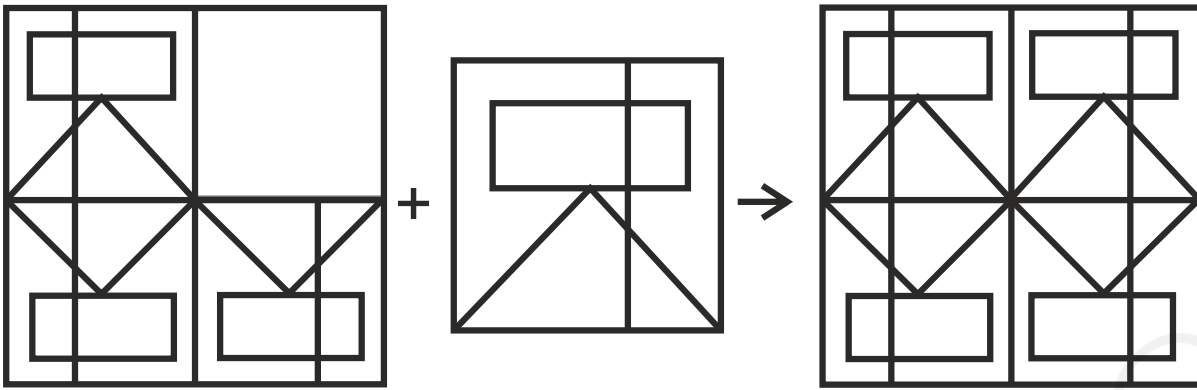

Hence, the **first option** is correct.

**Q.
111**

Directions: Select the option figure that will replace the question mark (?) in the figure given below to complete the pattern (Rotation is not allowed).

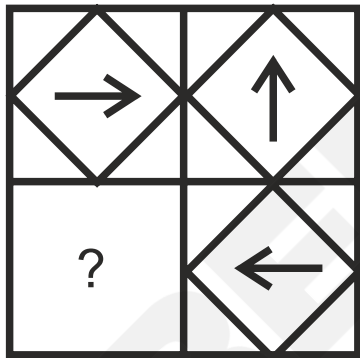

Option 1:

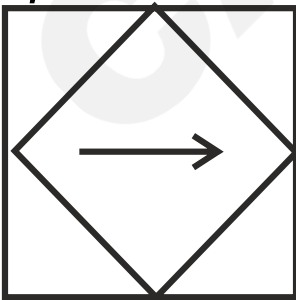

Option 2:

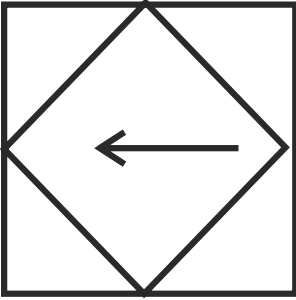

Option 3:

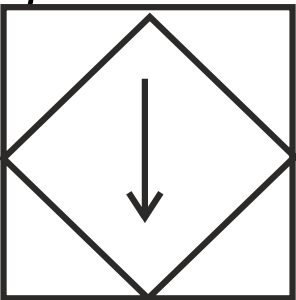

Option 4:

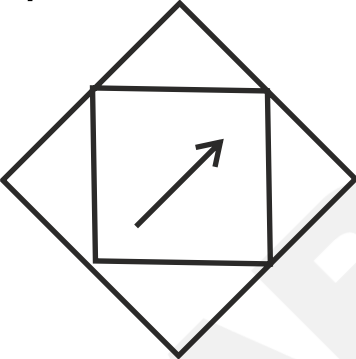

Correct Answer:

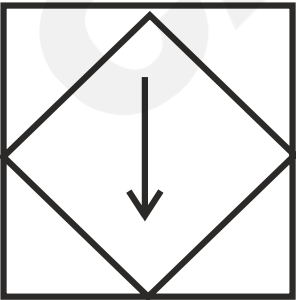

Solution:

Here, in the given figure the arrow is rotated by 90° in an anticlockwise direction. Therefore, on comparing the question figure and all the answer figures, the following figure will combine and make the complete pattern –

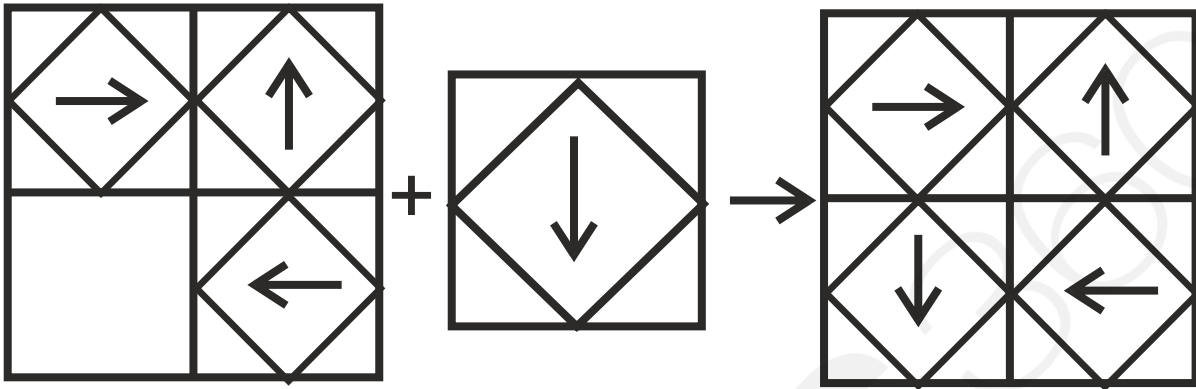

Hence, the **third option** is correct.

**Q.
112**

Directions: Select the option figure that will replace the question mark (?) in the figure given below to complete the pattern (Rotation is not allowed).

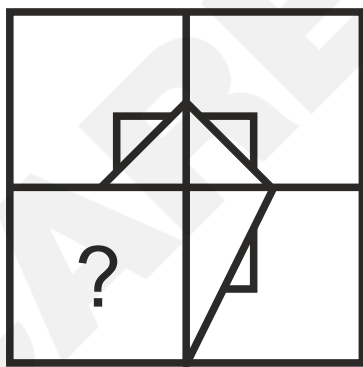

Option 1:

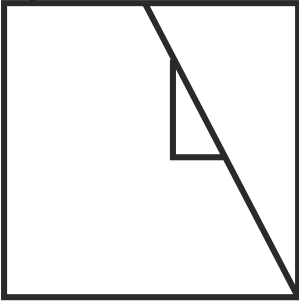

Option 2:

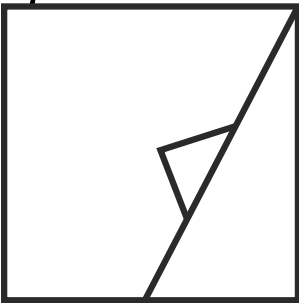

Option 3:

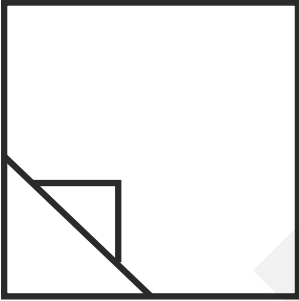

Option 4:

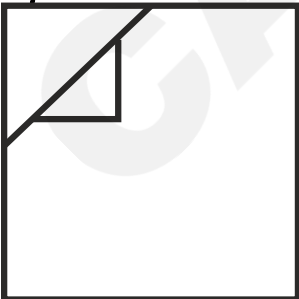

Correct Answer:

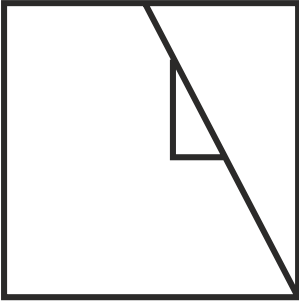

Solution:

On comparing the question figure and all the answer figures, the following figure will combine and make the complete pattern -

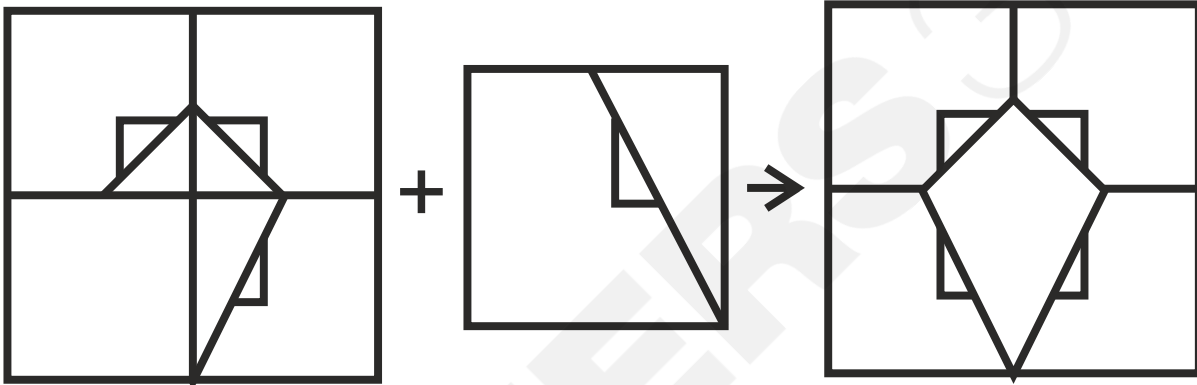

Hence, the **first option** is correct.

**Q.
113**

Directions: Which answer figure will complete the pattern in the question figure?

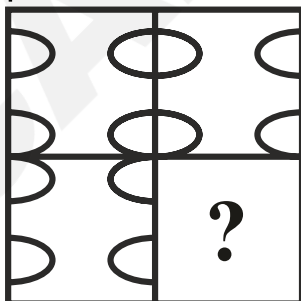

Option 1:

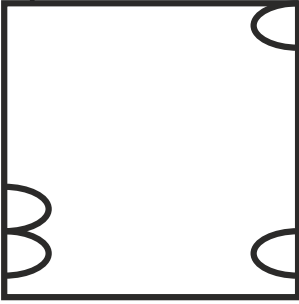

Option 2:

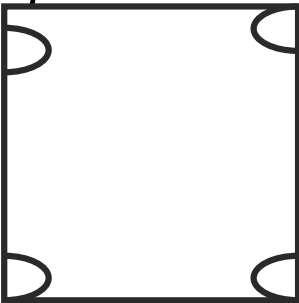

Option 3:

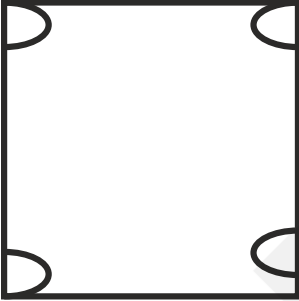

Option 4:

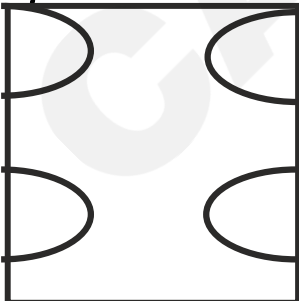

Correct Answer:

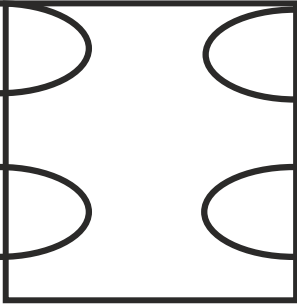

Solution:

On comparing the question figure and all the answer figures, the following figure will combine and make the complete pattern -

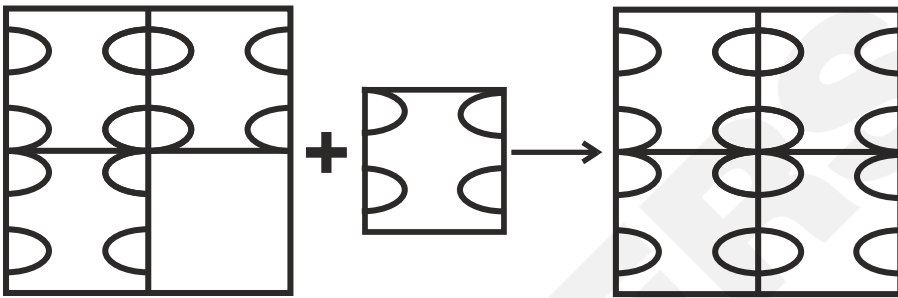

Hence, the **fourth option** is correct.

**Q.
114**

Directions: Which answer figure will complete the pattern in the question figure?

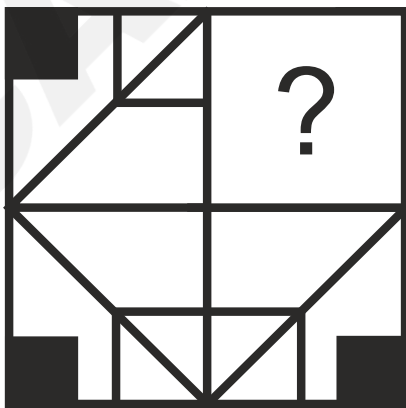

Option 1:

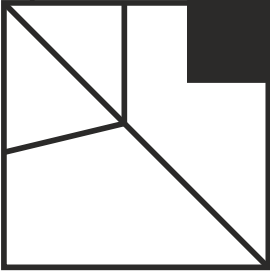

Option 2:

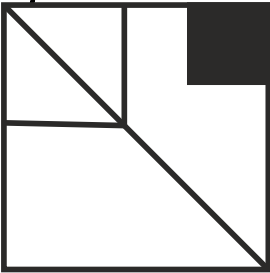

Option 3:

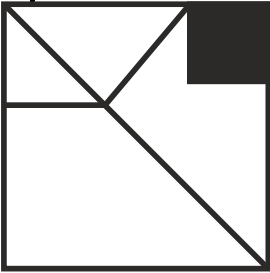

Option 4:



Correct Answer:

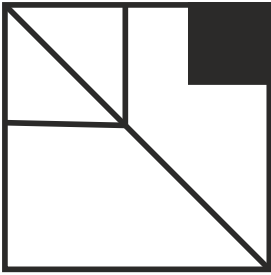

Solution:

On comparing the question figure and all the option figures, the following figure will combine and make the complete pattern -

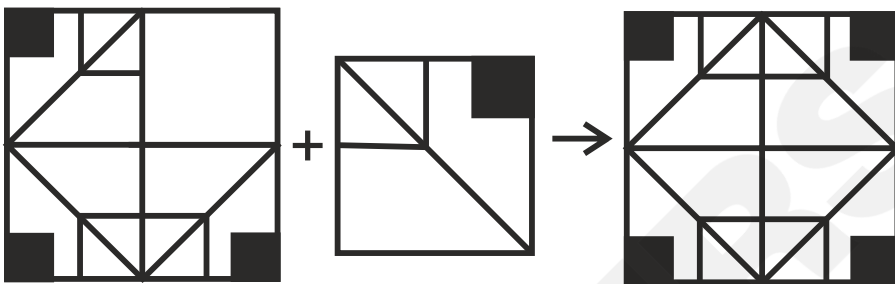

Hence, the **second option** is correct.

**Q.
115**

Directions: Select the option figure that will replace the question mark (?) in the figure given below to complete the pattern (Rotation is not allowed).

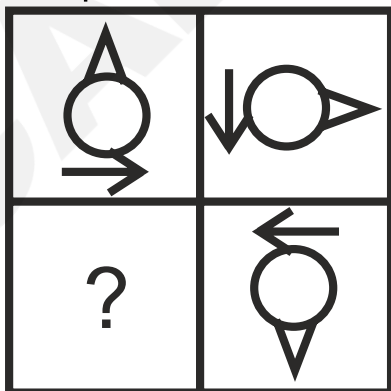

Option 1:

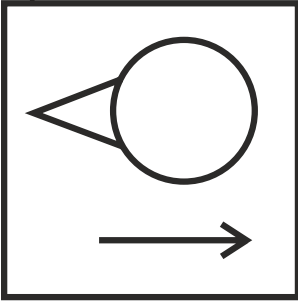

Option 2:

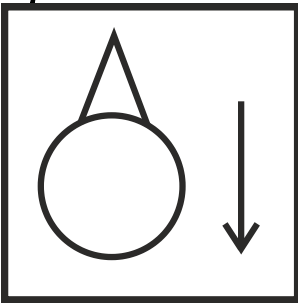

Option 3:

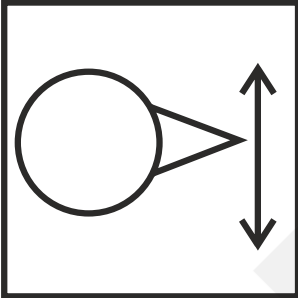

Option 4:

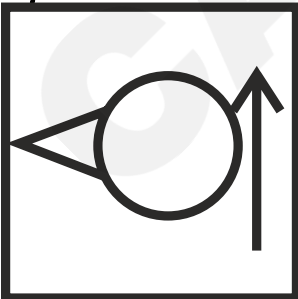

Correct Answer:

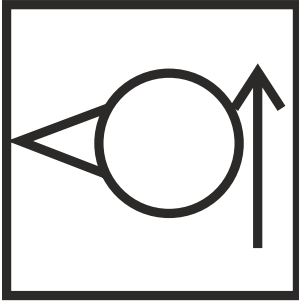

Solution:

The figure (circle with a cone on the top) with the arrow given in each box is rotated by 90 degrees in the clockwise direction. On comparing the question figure and all the answer figures, the following figure will combine and make the complete pattern -

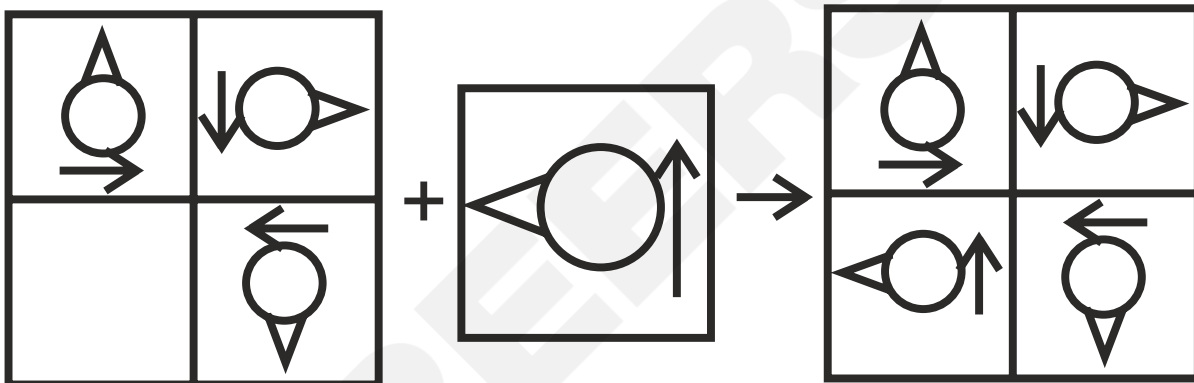

Hence, the **fourth option** is correct.

Q.
116

Directions: Select the option figure that will replace the question mark (?) in the figure given below to complete the pattern (Rotation is not allowed).

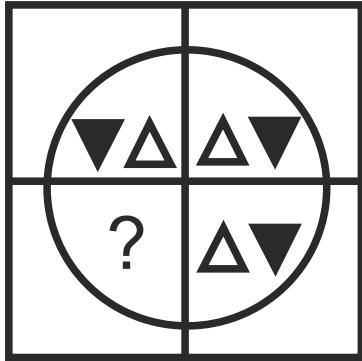

Option 1:



Option 2:



Option 3:



Option 4:



Correct Answer:



Solution:

On comparing the question figure and all the answer figures, the following figure will combine and make the complete pattern –

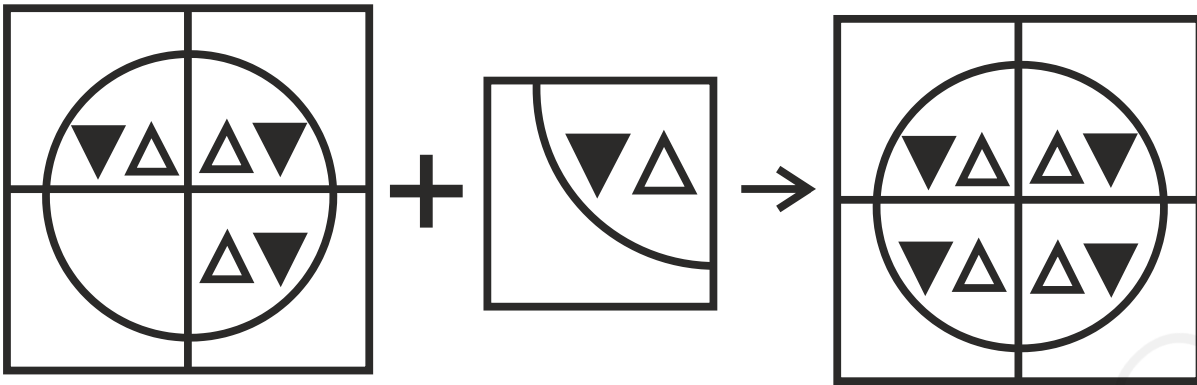

Hence, the **second option** is correct.

Q.
117

Directions: Select the option figure that will replace the question mark (?) in the figure given below to complete the pattern (Rotation is not allowed).

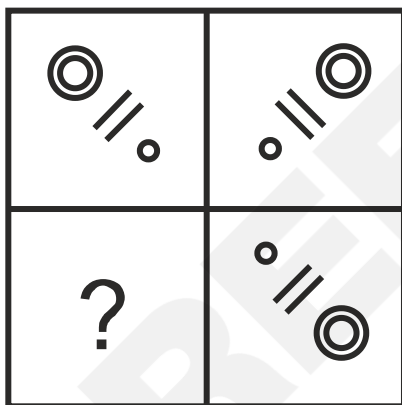

Option 1:

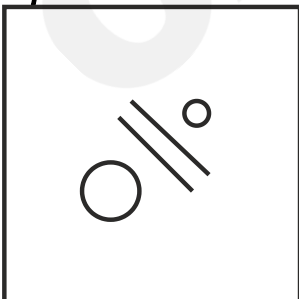

Option 2:

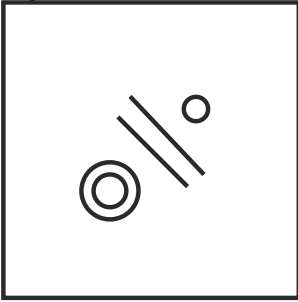

Option 3:

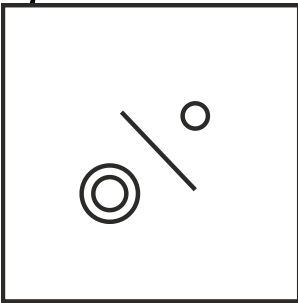

Option 4:



Correct Answer:



Solution:

On comparing the question figure and all the answer figures, the following figure will combine and make the complete pattern -

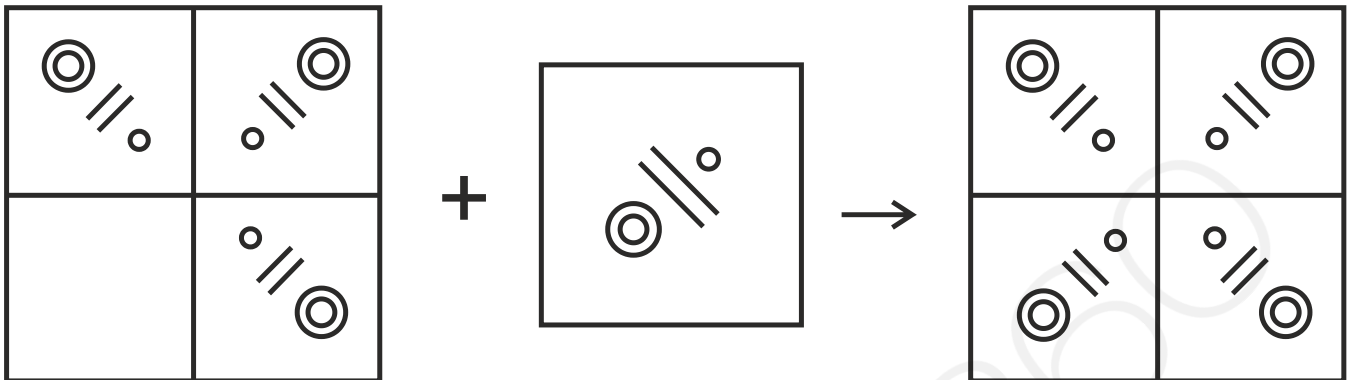

Hence, the **second option** is correct.

**Q.
118**

Directions: Select the option figure that will replace the question mark (?) in the figure given below to complete the pattern (Rotation is NOT allowed).

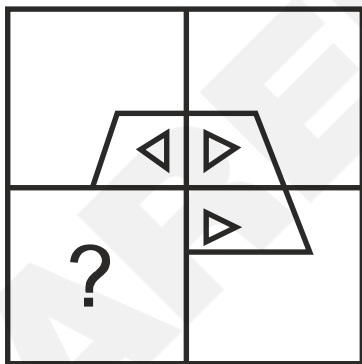

Option 1:

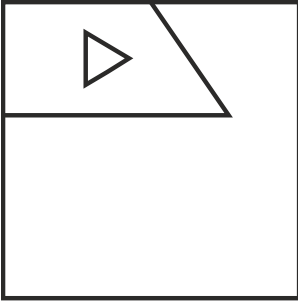

Option 2:

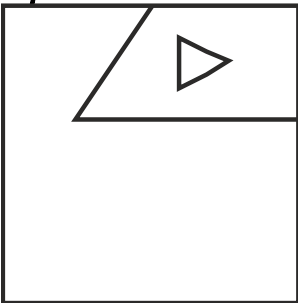

Option 3:

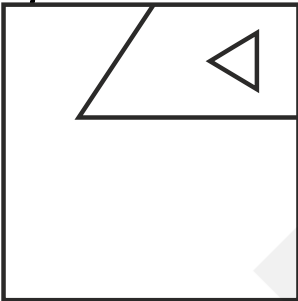

Option 4:

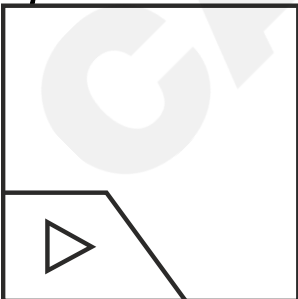

Correct Answer:

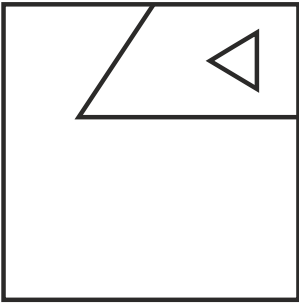

Solution:

On comparing the question figure and all the answer figures, the following figure will combine and make the complete pattern -

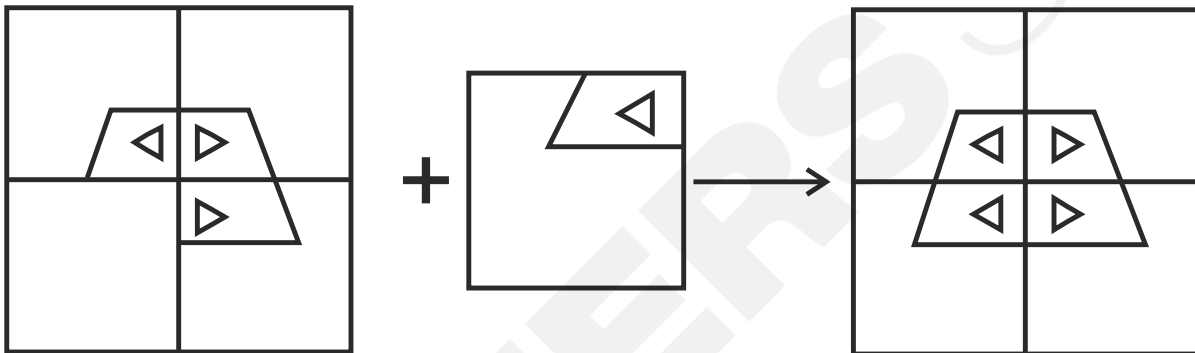

Hence, the **third option** is correct.

Q.
119

Directions: Select the option figure that will replace the question mark (?) in the figure given below to complete the pattern.

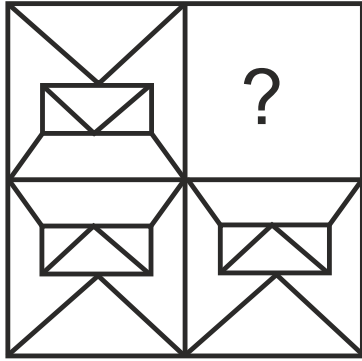

Option 1:

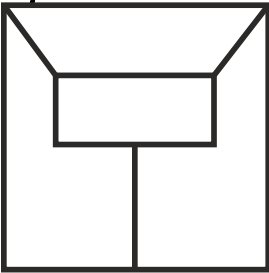

Option 2:



Option 3:

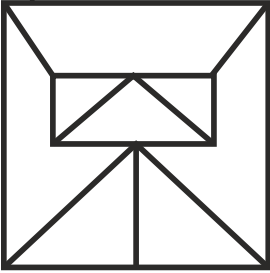

Option 4:



Correct Answer:



Solution:

On comparing the question figure and all the answer figures, the following figure will combine and make the complete pattern –

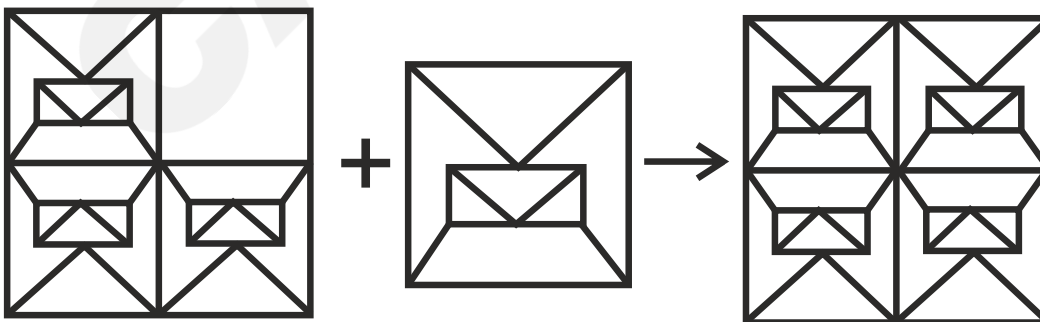

Hence, the **fourth option** is correct.

Q.
120

Directions: Which answer figure will complete the pattern in the question figure?

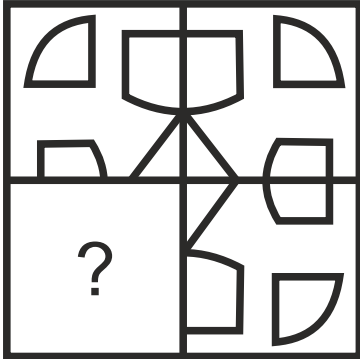

Option 1:

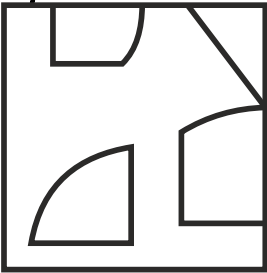

Option 2:

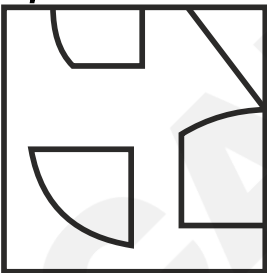

Option 3:

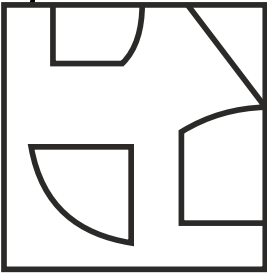

Option 4:

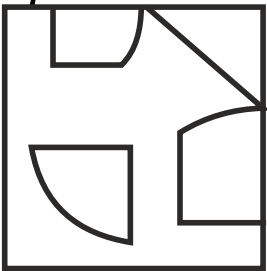

Correct Answer:

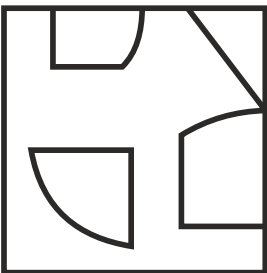

Solution:

On comparing the question figure and all the option figures, the following figure will combine and make the complete pattern -

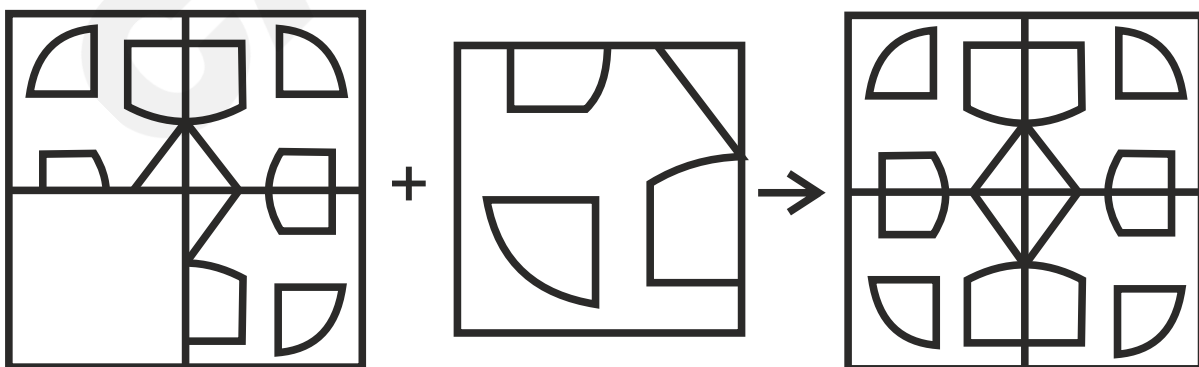

Hence, the **third option** is correct.

Q.
121

Directions: Select the option figure that will replace the question mark (?) in the figure given below to complete the pattern.

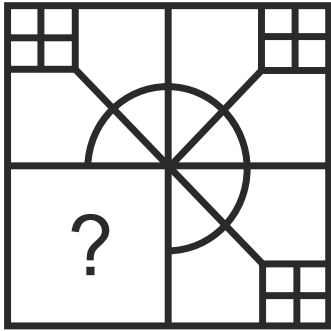

Option 1:

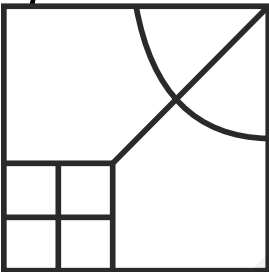

Option 2:

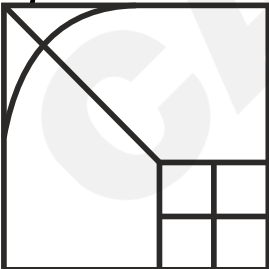

Option 3:

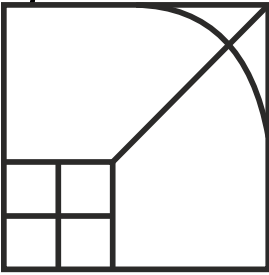

Option 4:

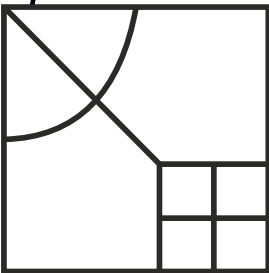

Correct Answer:

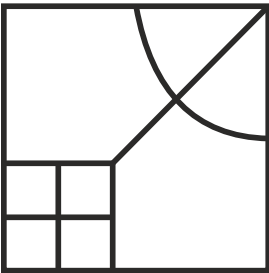

Solution:

On comparing the question figure and all the answer figures, the following figure will combine and make the complete pattern –

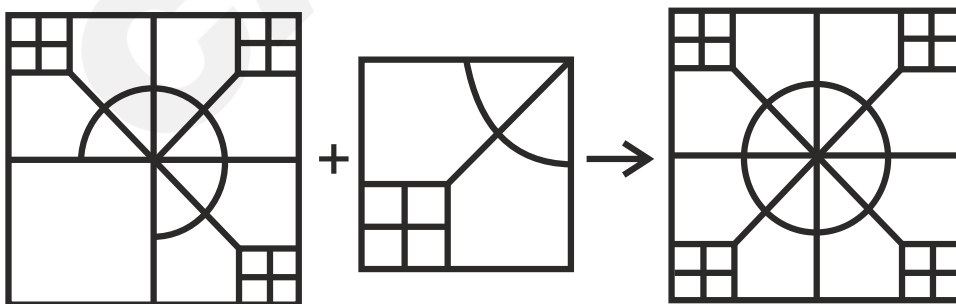

Hence, the **first option** is correct.

Q.
122

Directions: Select the option figure that will replace the question mark (?) in the figure given below to complete the pattern. (Rotation is not allowed.)

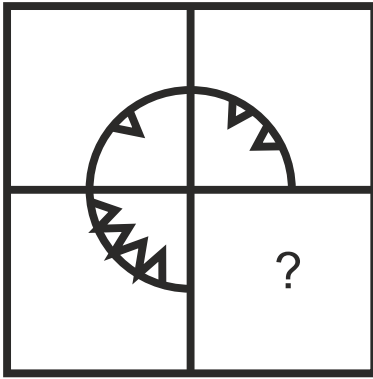

Option 1:

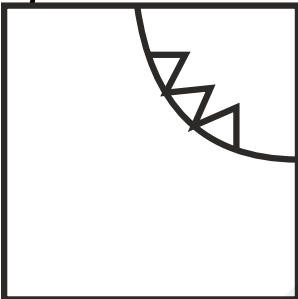

Option 2:

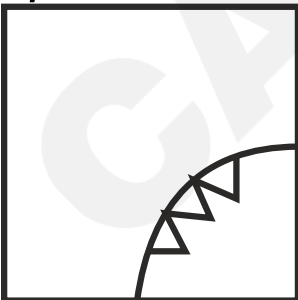

Option 3:

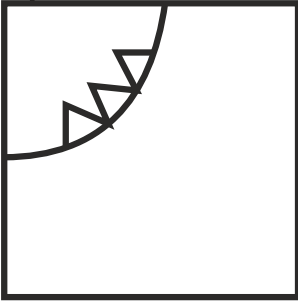

Option 4:



Correct Answer:



Solution:

Here, the number of triangles in the circle is increased by one in a clockwise direction. On comparing the question figure and all the option figures, the following figure will combine and make the complete pattern –

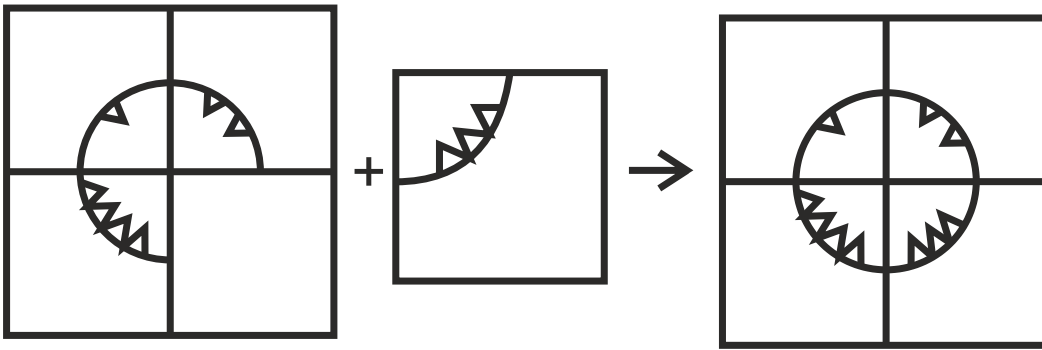

Hence, the **third option** is correct.

Q.
123

Directions: Which answer figure will complete the pattern in the question figure?

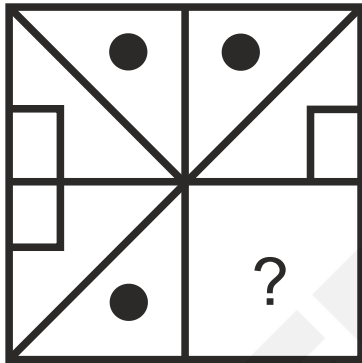

Option 1:

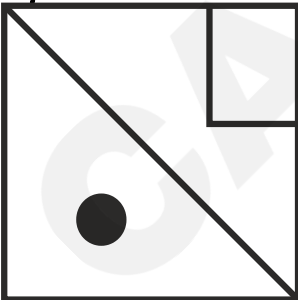

Option 2:

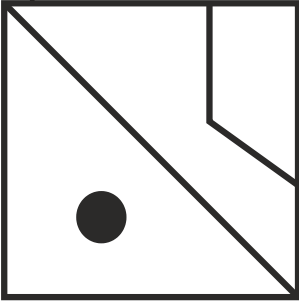

Option 3:

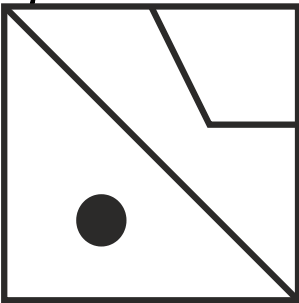

Option 4:

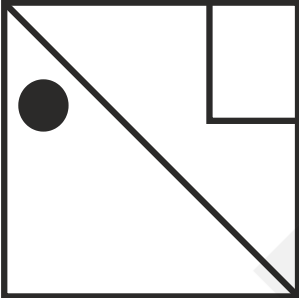

Correct Answer:

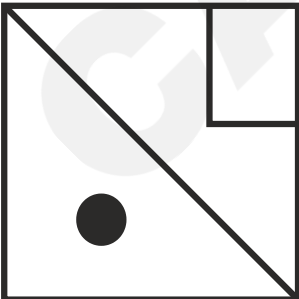

Solution:

On comparing the question figure and all the option figures, the following figure will combine and make the complete pattern -

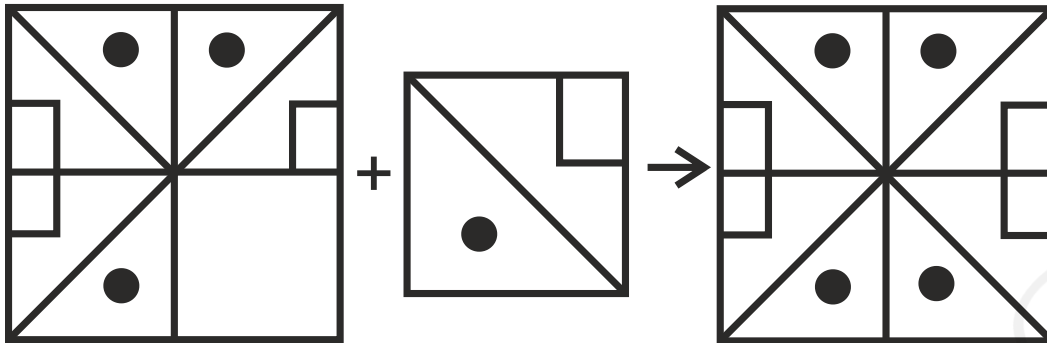

Hence, the **first option** is correct.

**Q.
124**

Directions: Select the option figure that will replace the question mark (?) in the figure given below to complete the pattern.

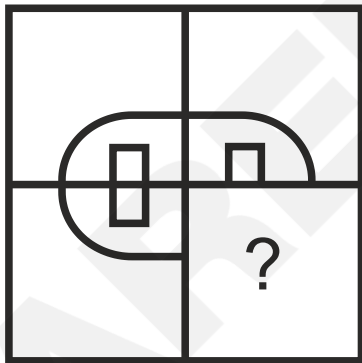

Option 1:

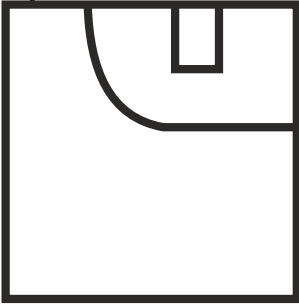

Option 2:

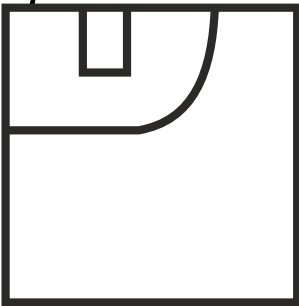

Option 3:

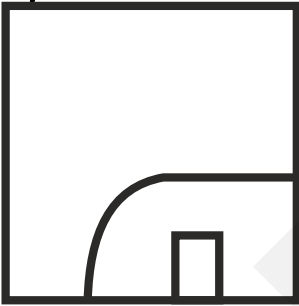

Option 4:



Correct Answer:

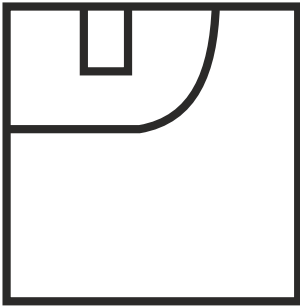

Solution:

On comparing the question figure and all the answer figures, the following figure will combine and make the complete pattern -

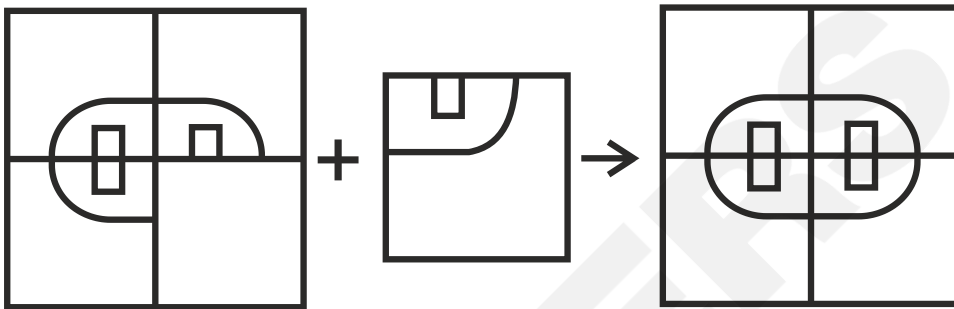

Hence, the **second option** is correct.

**Q.
125**

Directions: Select the option figure that will replace the question mark (?) in the figure given below to complete the pattern. (Rotation is not allowed.)

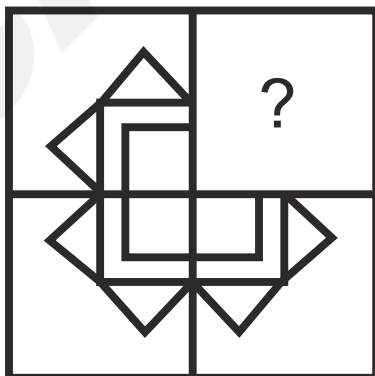

Option 1:



Option 2:

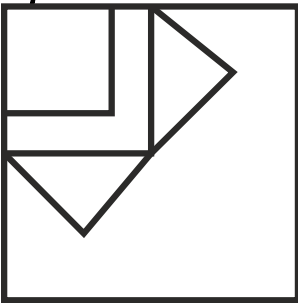

Option 3:

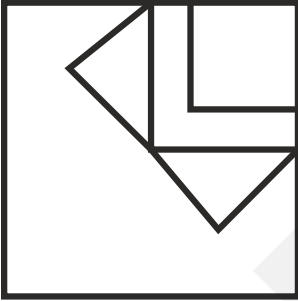

Option 4:



Correct Answer:



Solution:

On comparing the question figure and all the option figures, the following figure will combine and make the complete pattern -

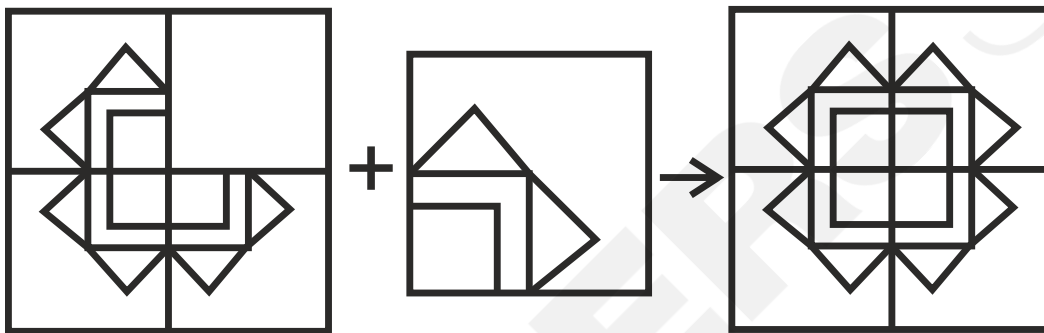

Hence, the **first option** is correct.

**Q.
126**

Directions: Which answer figure will complete the pattern in the question figure?

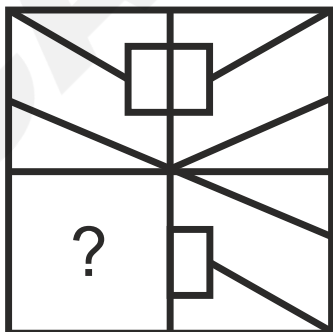

Option 1:

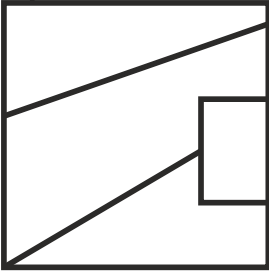

Option 2:

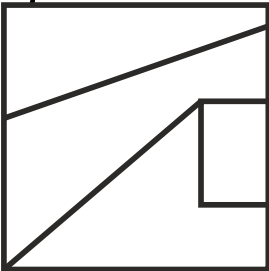

Option 3:

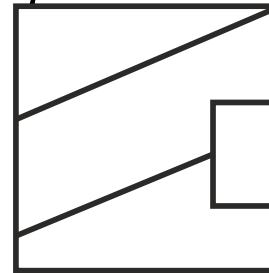

Option 4:

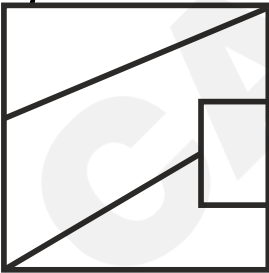

Correct Answer:

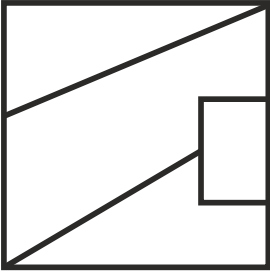

Solution:

On comparing the question figure and all the answer figures, the following figure will combine and make the complete pattern -

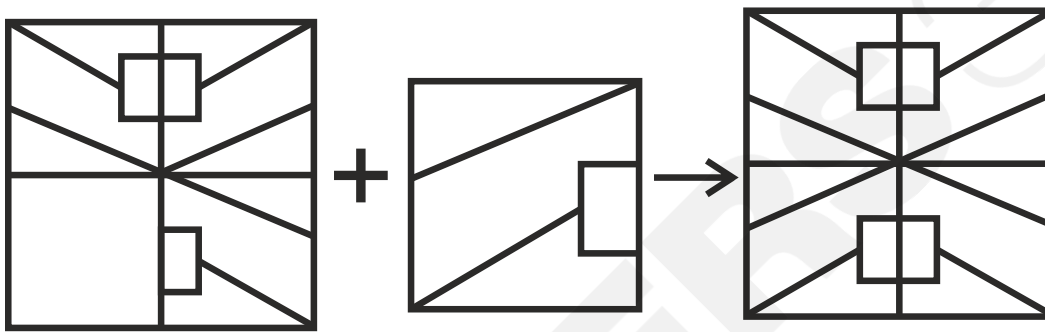

Hence, the **fourth option** is correct.

**Q.
127**

Directions: Which answer figure will complete the pattern in the question figure?

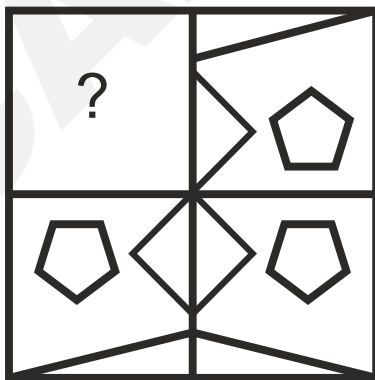

Option 1:

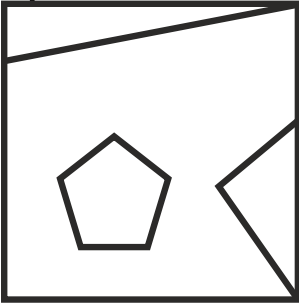

Option 2:

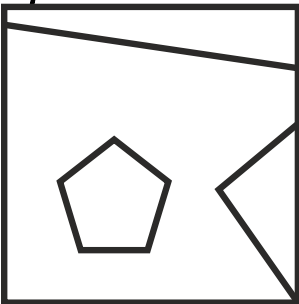

Option 3:

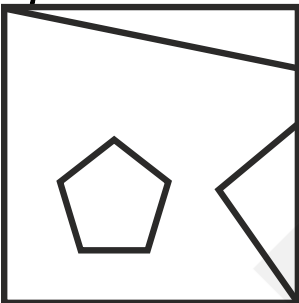

Option 4:

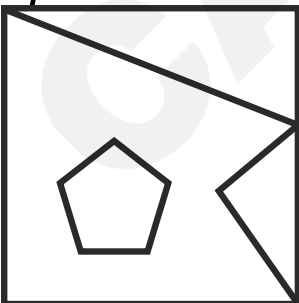

Correct Answer:

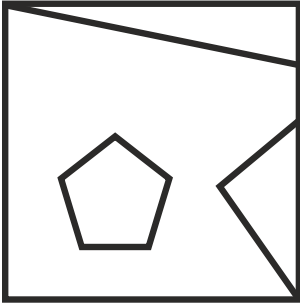

Solution:

On comparing the question figure and all the option figures, the following figure will combine and make the complete pattern -

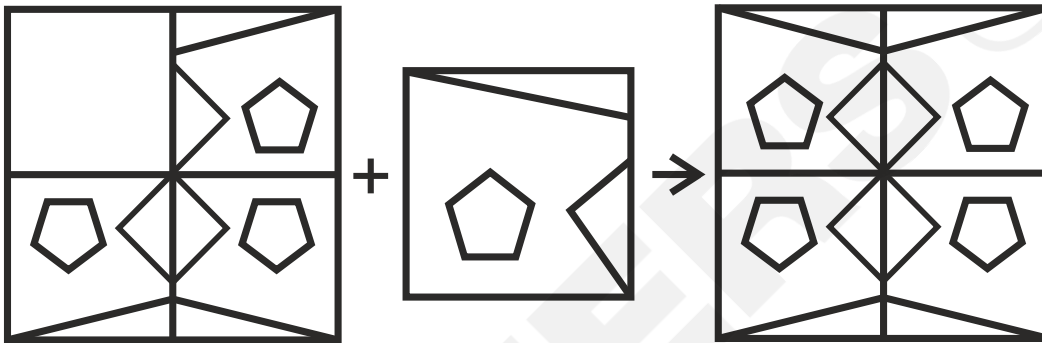

Hence, the **third option** is correct.

**Q.
128**

Directions: Which answer figure will complete the pattern in the question figure?

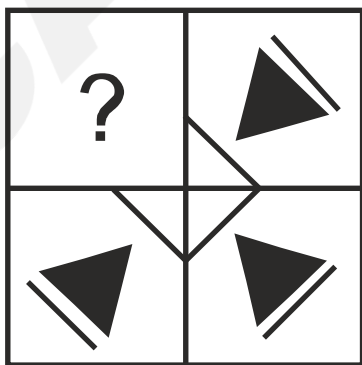

Option 1:

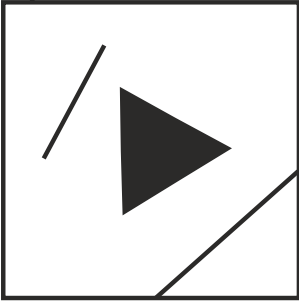

Option 2:

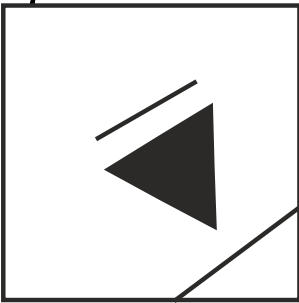

Option 3:



Option 4:



Correct Answer:

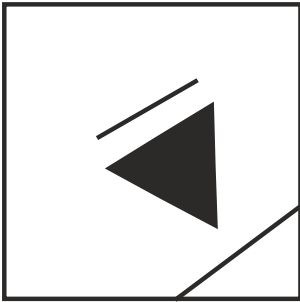

Solution:

On comparing the question figure and all the answer figures, the following figure will combine and make the complete pattern -

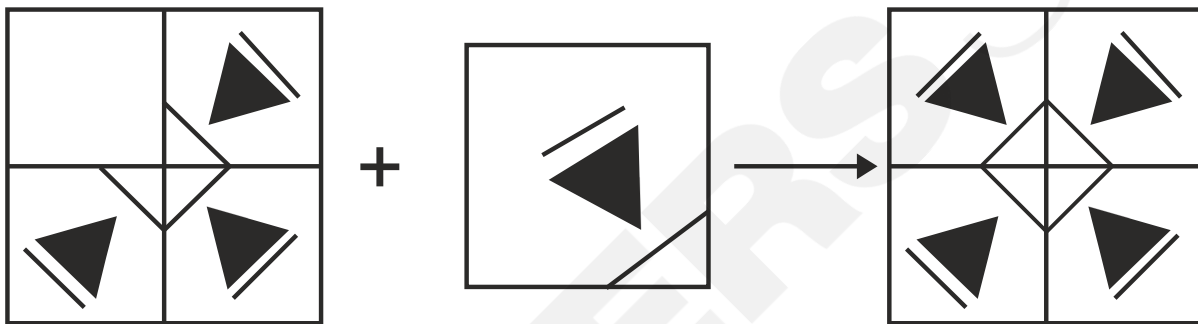

Hence, the **second option** is correct.

Q.
129

Directions: Select the option figure that will replace the question mark (?) in the figure given below to complete the pattern. (Rotation is not allowed.)

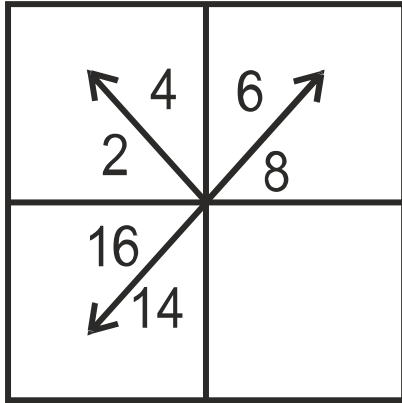

Option 1:

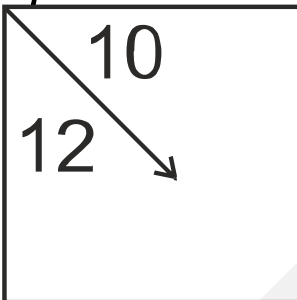

Option 2:

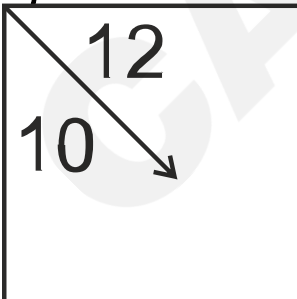

Option 3:

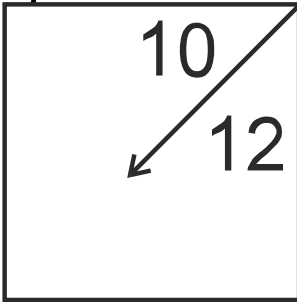

Option 4:

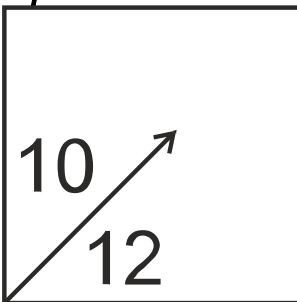

Correct Answer:

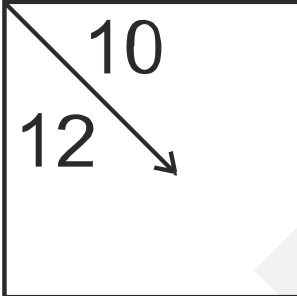

Solution:

Here, the number is increased by 2 in the clockwise direction. On comparing the question figure and all the option figures, the following figure will combine and make the complete pattern -

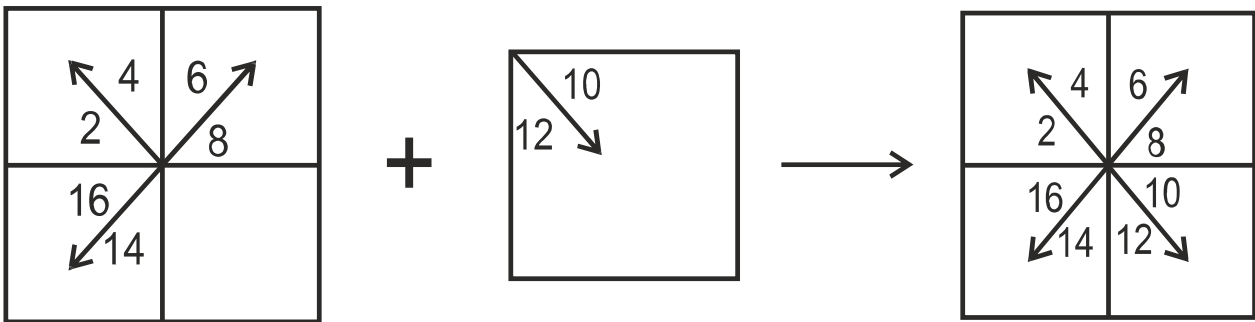

Hence, the **first option** is correct.

**Q.
130**

Directions: Select the option figure, that will replace the question mark (?) in the figure given below to complete the pattern.

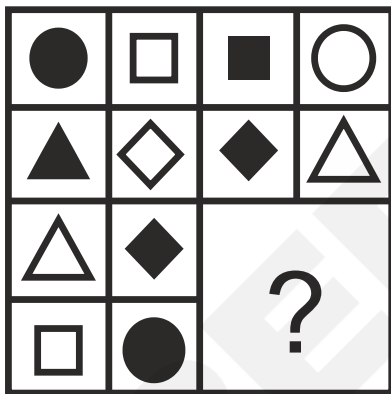

Option 1:

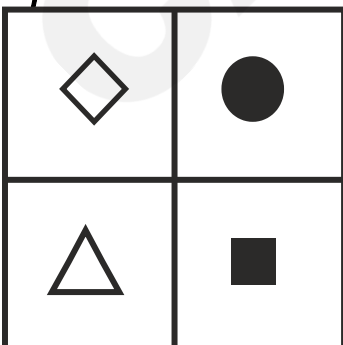

Option 2:

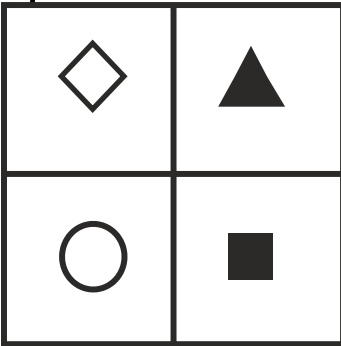

Option 3:

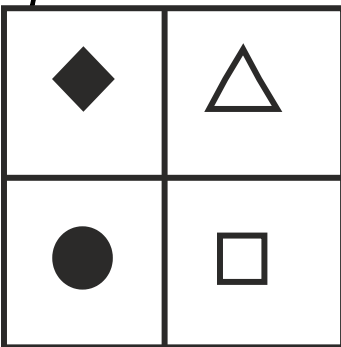

Option 4:

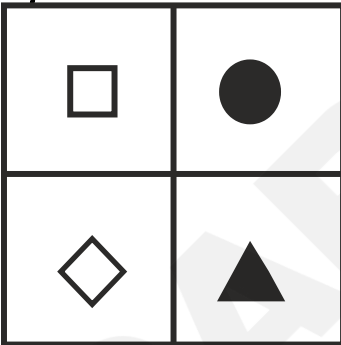

Correct Answer:

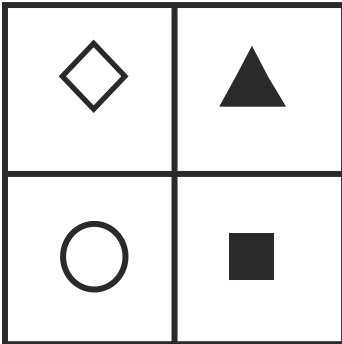

Solution:

Here, the geometrical shapes given in the opposite box are changed from shaded to unshaded and unshaded to shaded. On comparing the question figure and all the answer figures, the following figure will combine and make the complete pattern -

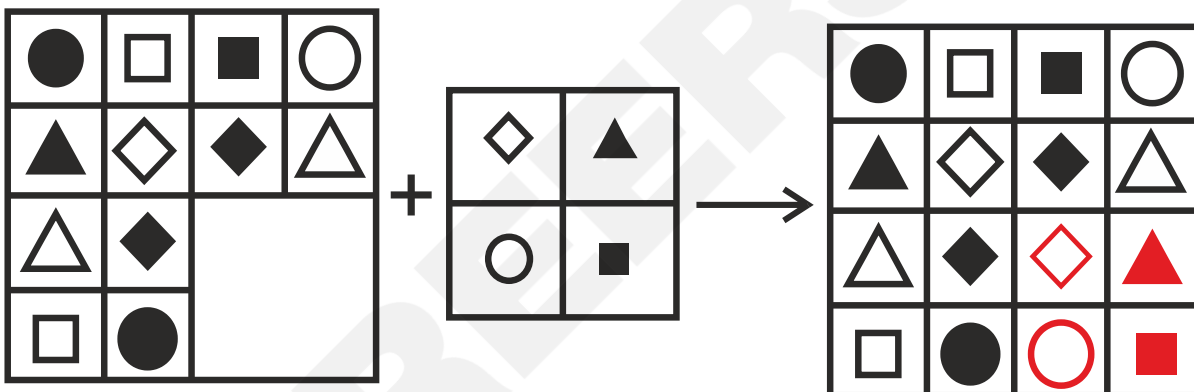

Hence, the **second option** is correct.

Q.
131

Directions: Select the option figure that will replace the question mark (?) in the figure given below to complete the pattern.

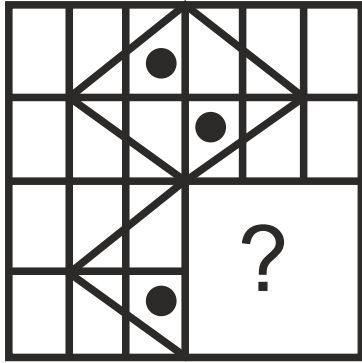

Option 1:

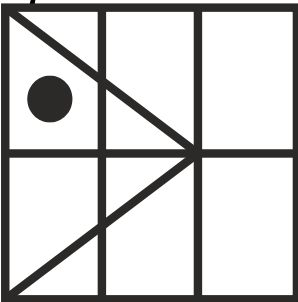

Option 2:

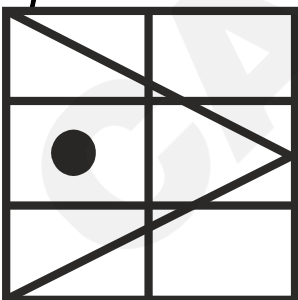

Option 3:

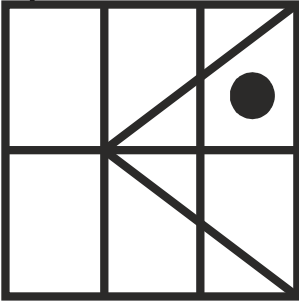

Option 4:

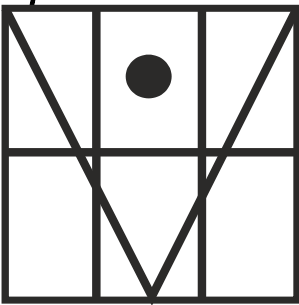

Correct Answer:

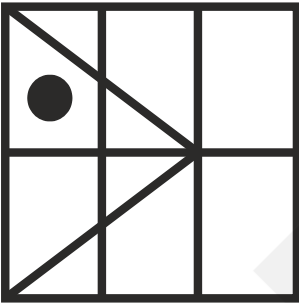

Solution:

On comparing the question figure and all the answer figures, the following figure will combine and make the complete pattern -

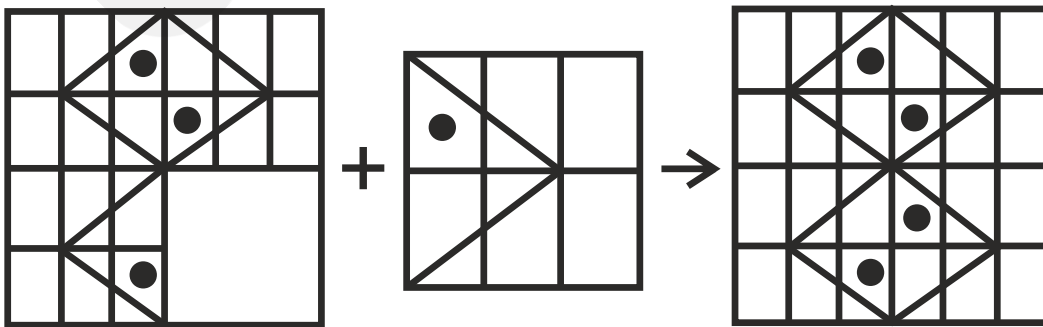

Hence, the **first option** is correct.

**Q.
132**

Directions: Select the option figure that will replace the question mark (?) in the figure given below to complete the pattern (Rotation is not allowed).

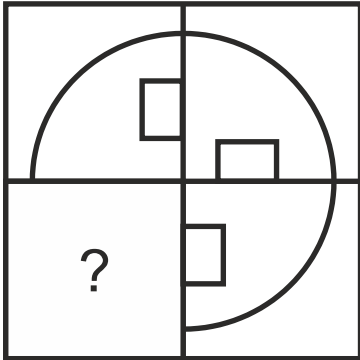

Option 1:

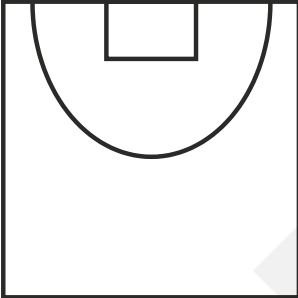

Option 2:

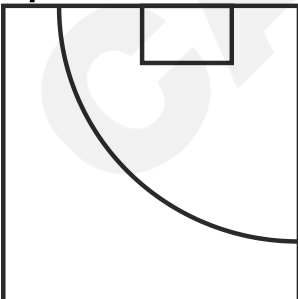

Option 3:

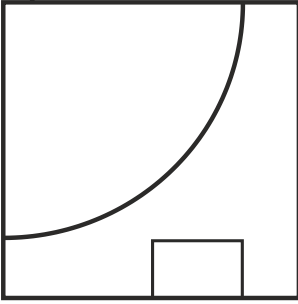

Option 4:

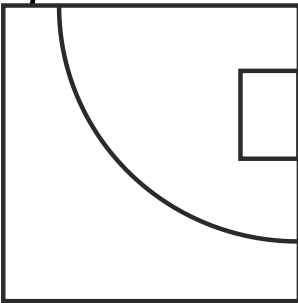

Correct Answer:

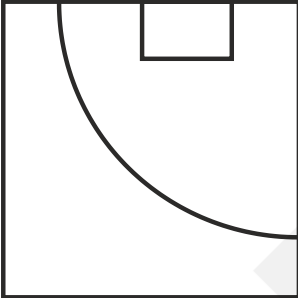

Solution:

Here, each part is rotated by 90° in a clockwise direction. On comparing the question figure and all the answer figures, the following figure will combine and make the complete pattern –

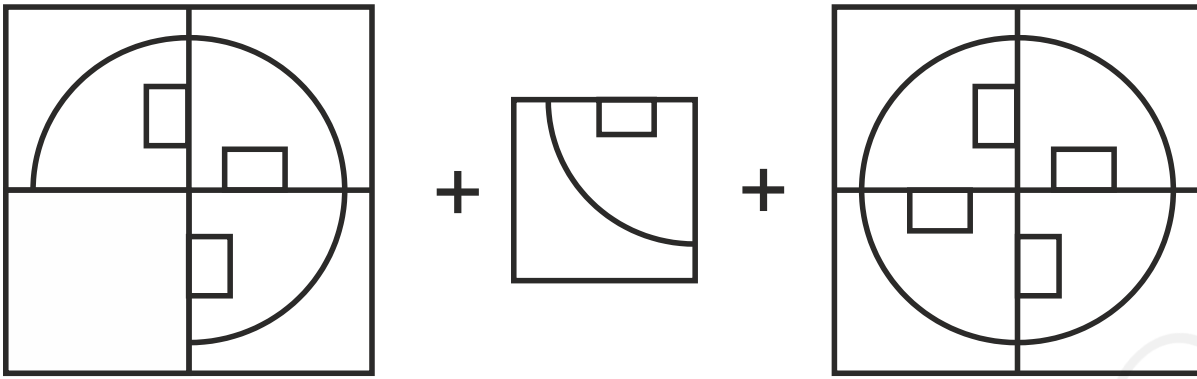

Hence, the **second option** is correct.

Q.
133

Directions: Which answer figure will complete the pattern in the question figure (Rotation is not allowed)?

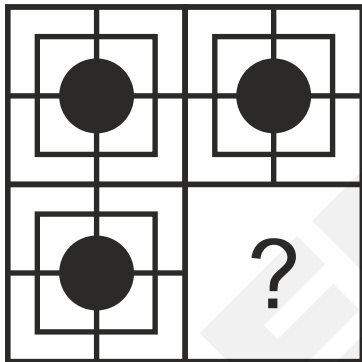

Option 1:

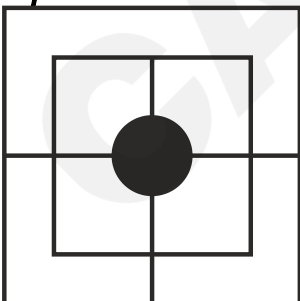

Option 2:

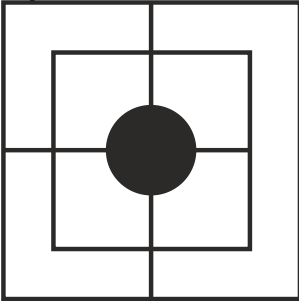

Option 3:

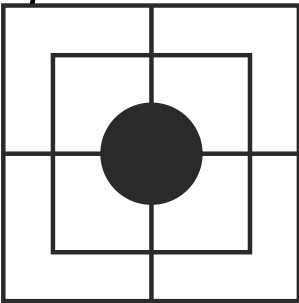

Option 4:

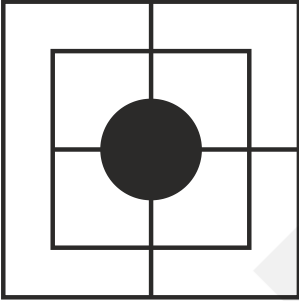

Correct Answer:

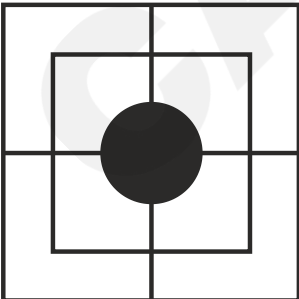

Solution:

On comparing the question figure and all the answer figures, the following figure will combine and make the complete pattern -

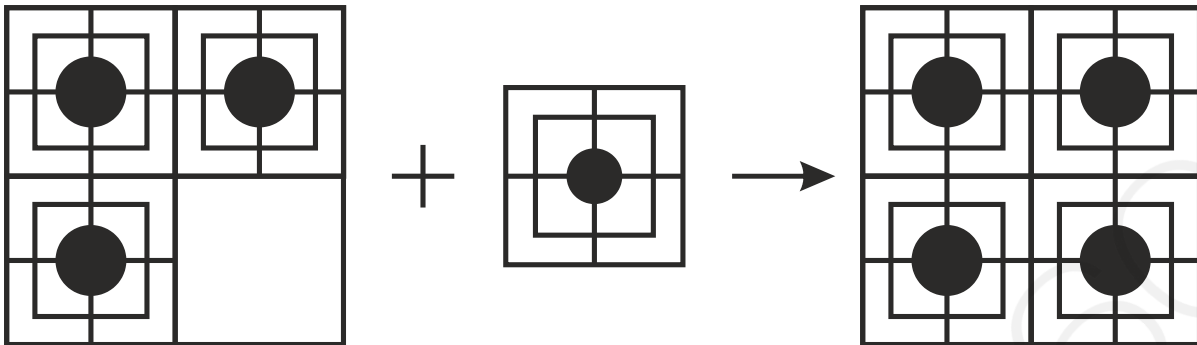

Hence, the **third option** is correct.

**Q.
134**

Directions: Select the option figure that will replace the question mark (?) in the figure given below to complete the pattern. (Rotation is not allowed.)

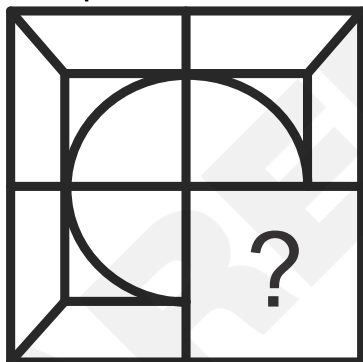

Option 1:

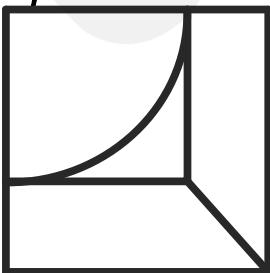

Option 2:

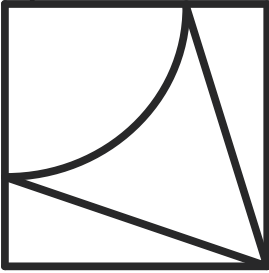

Option 3:

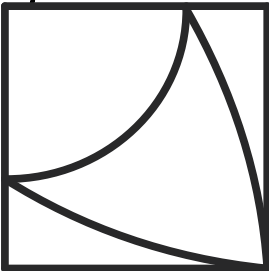

Option 4:

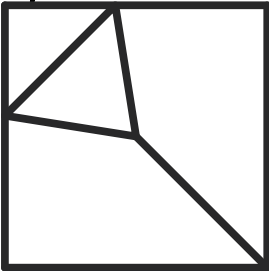

Correct Answer:



Solution:

On comparing the question figure and all the option figures, the following figure will combine and make the complete pattern -

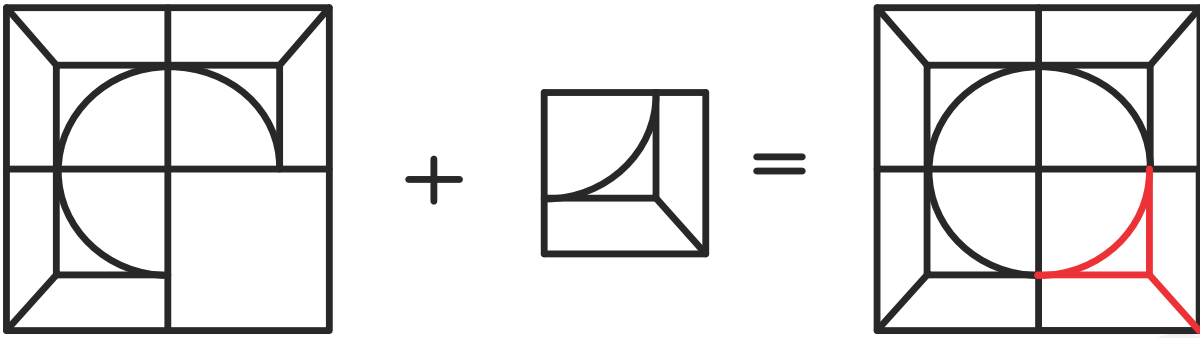

Hence, the **first option** is correct.

Q.
135

Directions: Which answer figure will complete the pattern in the question figure?

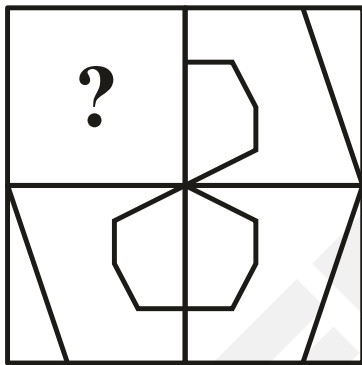

Option 1:

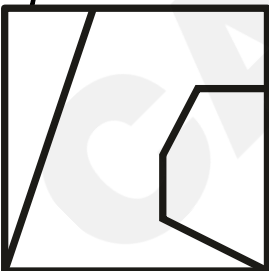

Option 2:



Option 3:

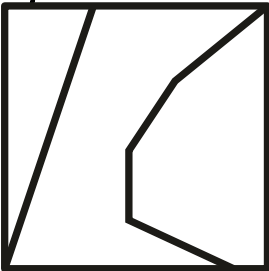

Option 4:

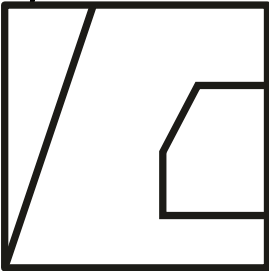

Correct Answer:



Solution:

On comparing the question figure and all the option figures, the following figure will combine and make the complete pattern -

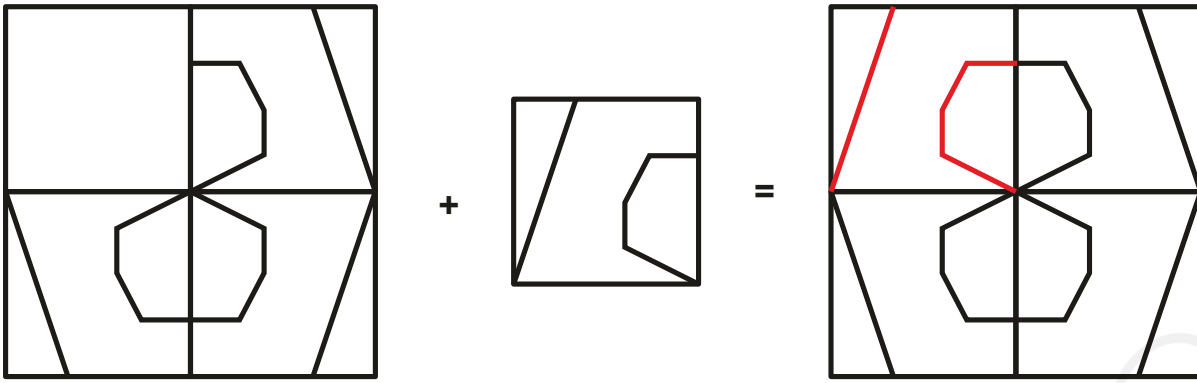

Hence, the **first option** is correct.

Q.
136

Directions: Which answer figure will complete the pattern in the question figure?

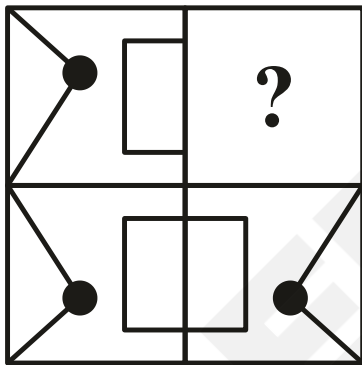

Option 1:

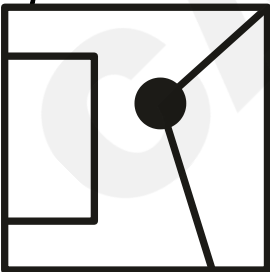

Option 2:

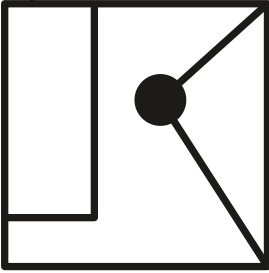

Option 3:

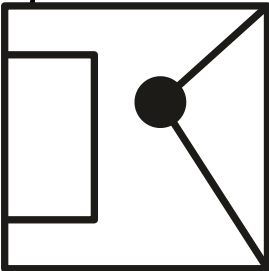

Option 4:

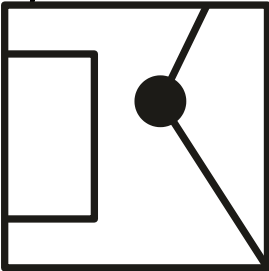

Correct Answer:

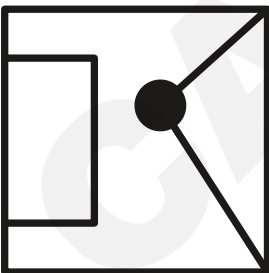

Solution:

On comparing the question figure and all the option figures, the following figure will combine and make the complete pattern -

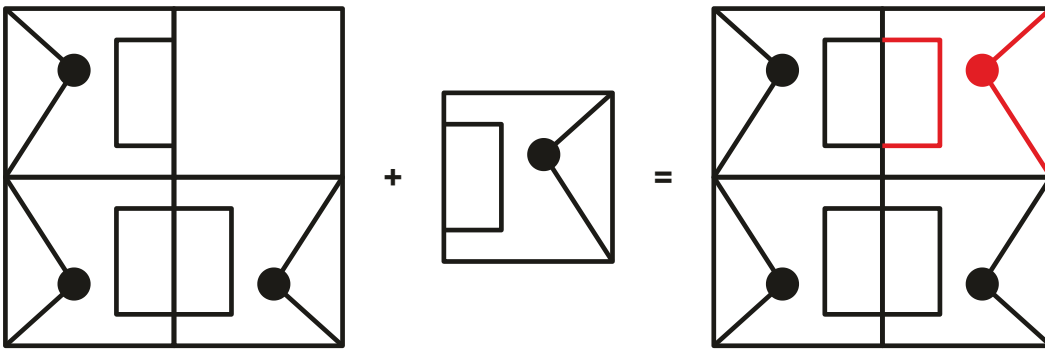

Hence, the **third option** is correct.

**Q.
137**

Directions: Select the option figure that will replace the question mark (?) in the figure given below to complete the pattern. (Rotation is not allowed.)

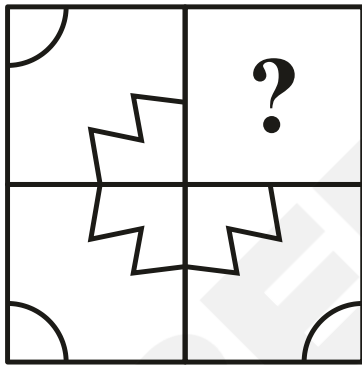

Option 1:



Option 2:

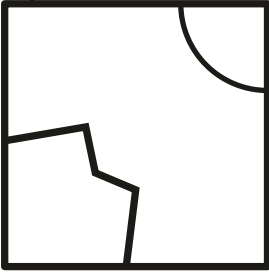

Option 3:

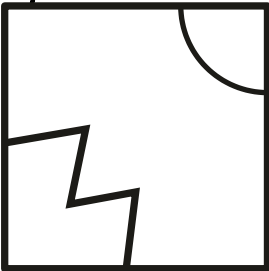

Option 4:

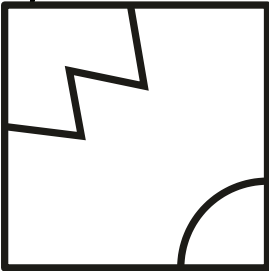

Correct Answer:



Solution:

On comparing the question figure and all the option figures, the following figure will combine and make the complete pattern -

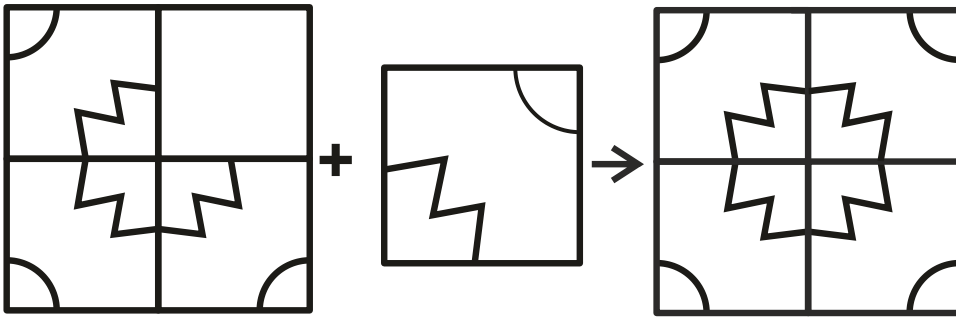

Hence, the **third option** is correct.

Q.
138

Directions: Select the option figure that will replace the question mark (?) in the figure given below to complete the pattern. (Rotation is not allowed.)

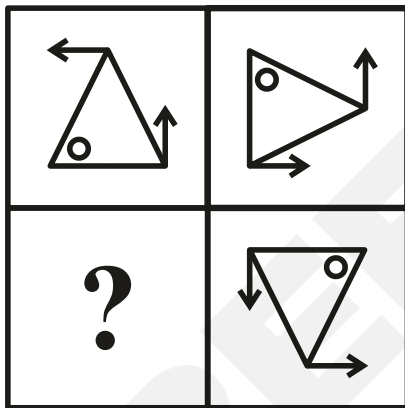

Option 1:

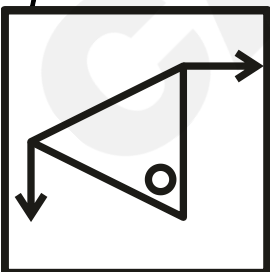

Option 2:

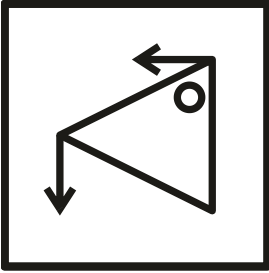

Option 3:

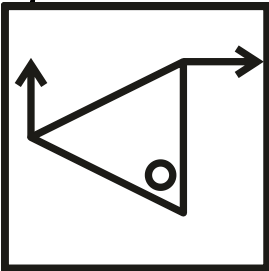

Option 4:

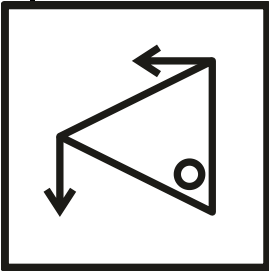

Correct Answer:

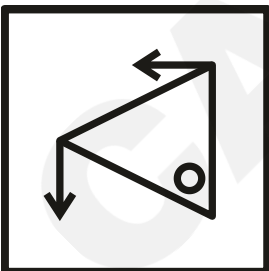

Solution:

Here, the triangle is being rotated in a clockwise direction. On comparing the question figure and all the option figures, the following figure will combine and make the complete pattern –

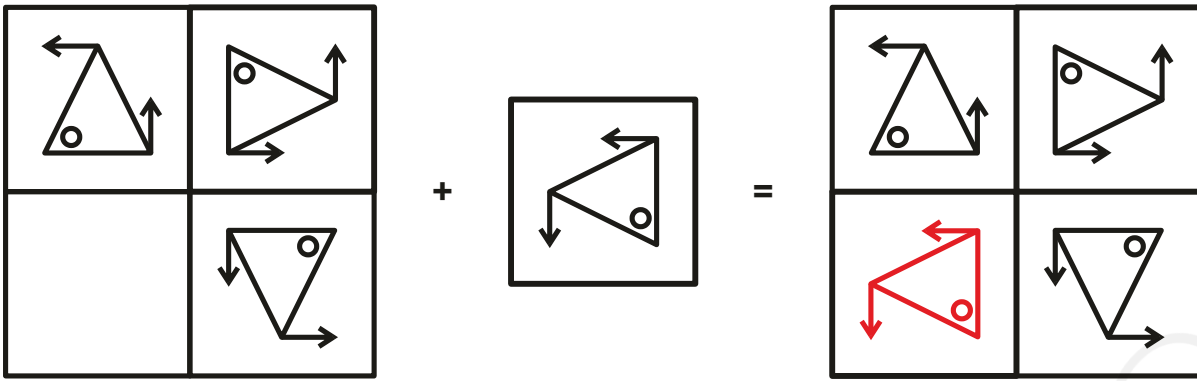

Hence, the **fourth option** is correct.

Q.
139

Directions: Select the option figure that will replace the question mark (?) in the figure given below to complete the pattern. (Rotation is not allowed.)

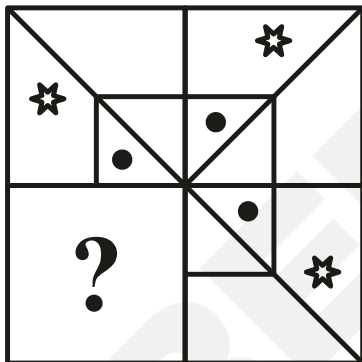

Option 1:

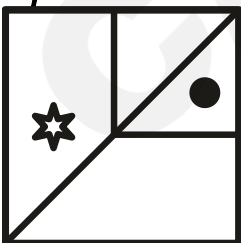

Option 2:

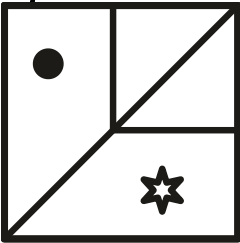

Option 3:

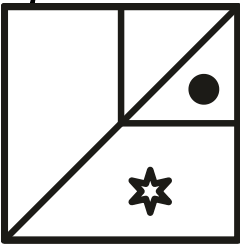

Option 4:

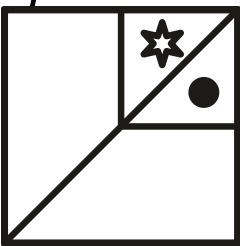

Correct Answer:

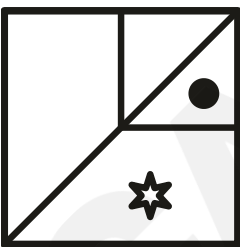

Solution:

On comparing the question figure and all the option figures, the following figure will combine and make the complete pattern –

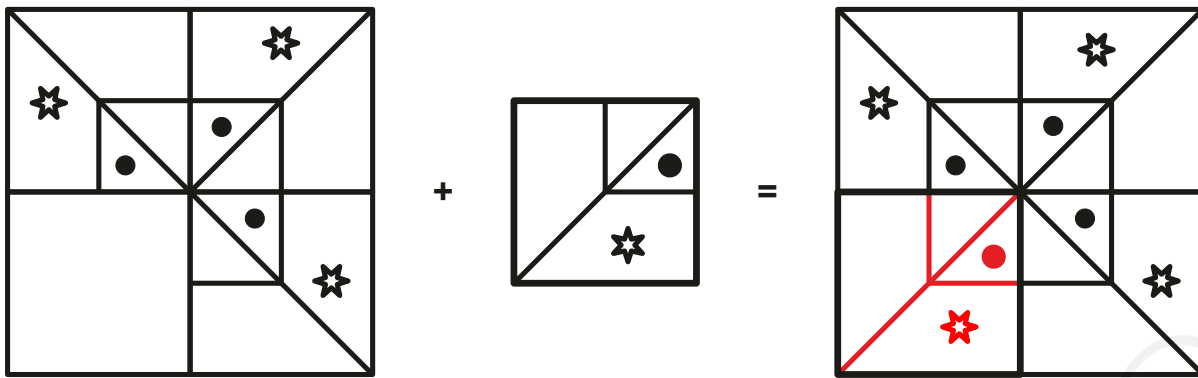

Hence, the **third option** is correct.

Q.
140

Directions: Which answer figure will complete the pattern in the question figure?

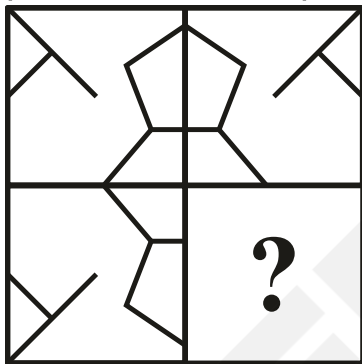

Option 1:

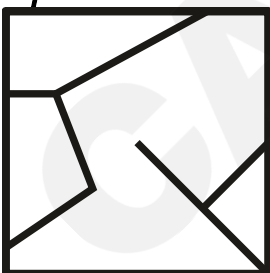

Option 2:

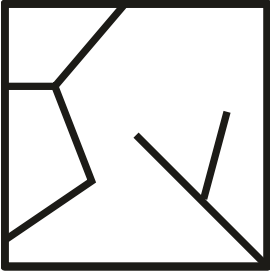

Option 3:

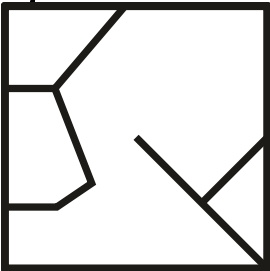

Option 4:

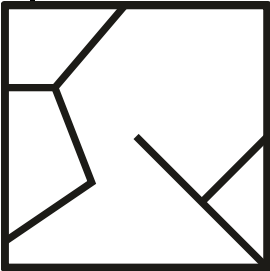

Correct Answer:

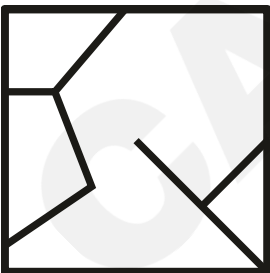

Solution:

On comparing the question figure and all the option figures, the following figure will combine and make the complete pattern -

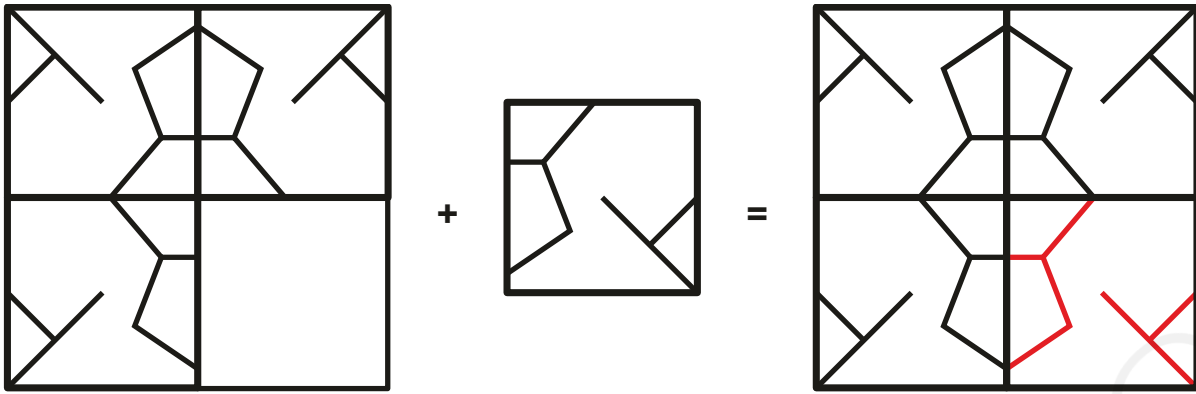

Hence, the **fourth option** is correct.

**Q.
141**

Directions: Select the option figure that will replace the question mark (?) in the figure given below to complete the pattern. (Rotation is not allowed.)

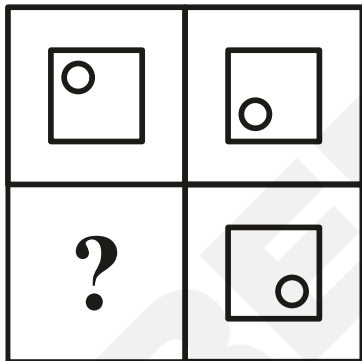

Option 1:

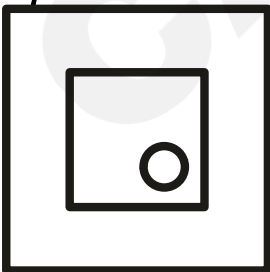

Option 2:

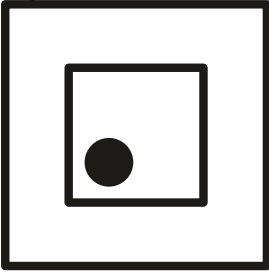

Option 3:

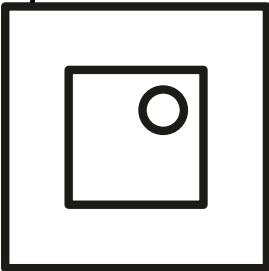

Option 4:

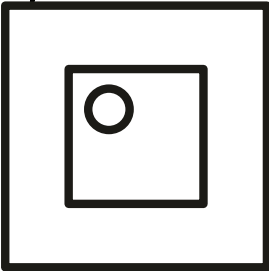

Correct Answer:

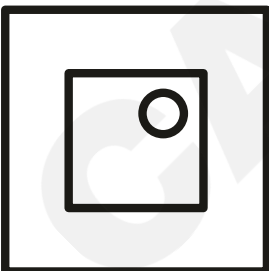

Solution:

On comparing the question figure and all the option figures, the following figure will combine and make the complete pattern -

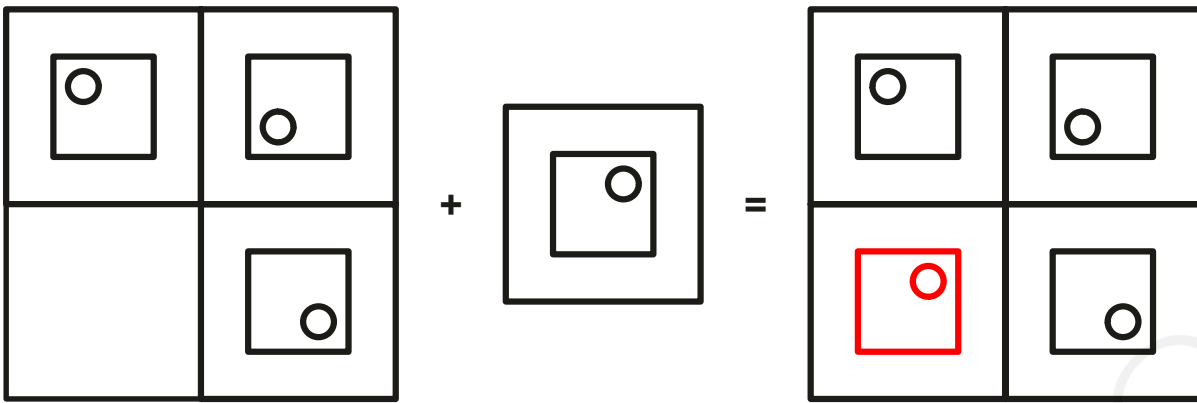

The circle inside the small square is shifting its position from one corner to another in the anticlockwise direction.

Hence, the **third option** is correct.

Q.
142

Directions: Which answer figure will complete the pattern in the question figure?

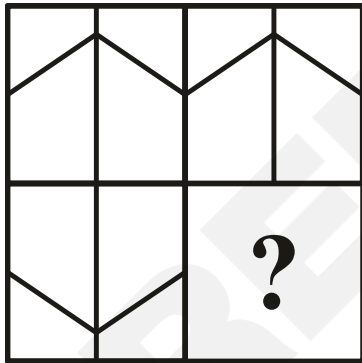

Option 1:

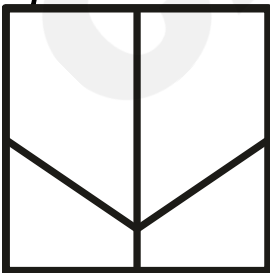

Option 2:

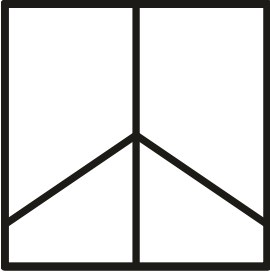

Option 3:

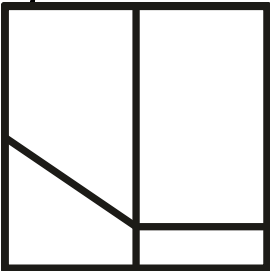

Option 4:

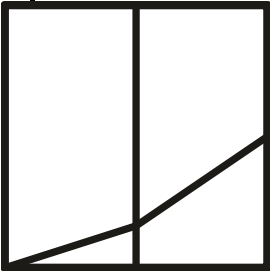

Correct Answer:



Solution:

On comparing the question figure and all the option figures, the following figure will combine and make the complete pattern -

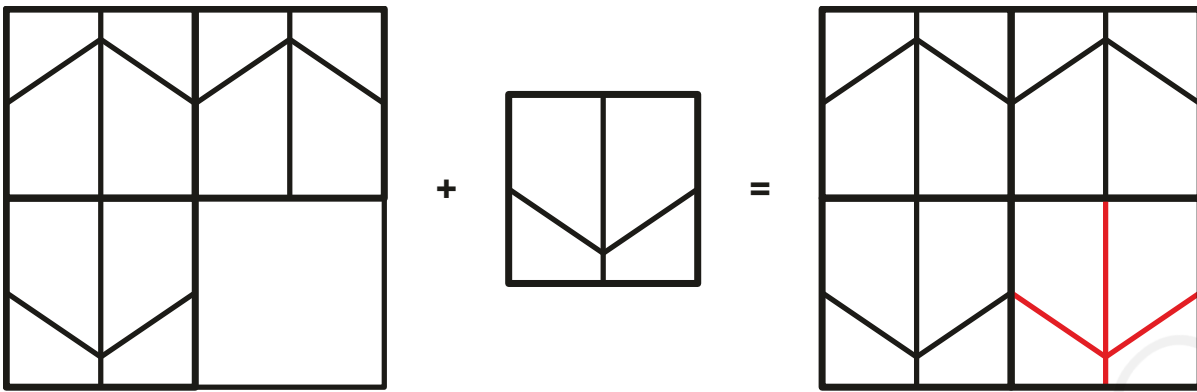

Hence, the **first option** is correct.

**Q.
143**

Directions: Which answer figure will complete the pattern in the question figure?

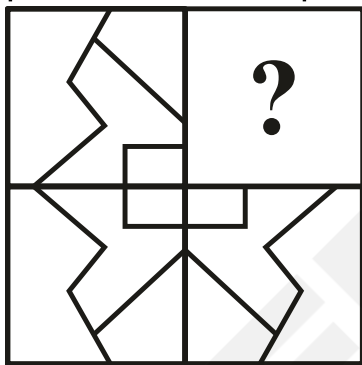

Option 1:

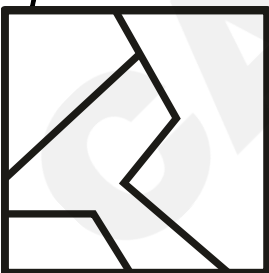

Option 2:

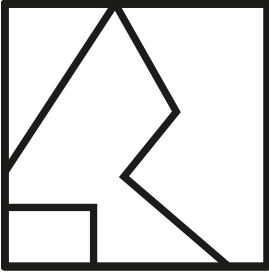

Option 3:

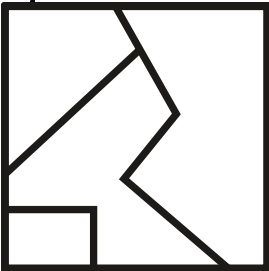

Option 4:

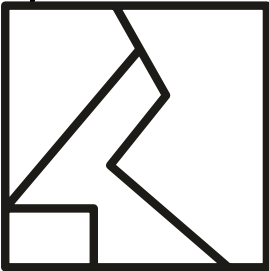

Correct Answer:



Solution:

On comparing the question figure and all the option figures, the following figure will combine and make the complete pattern -

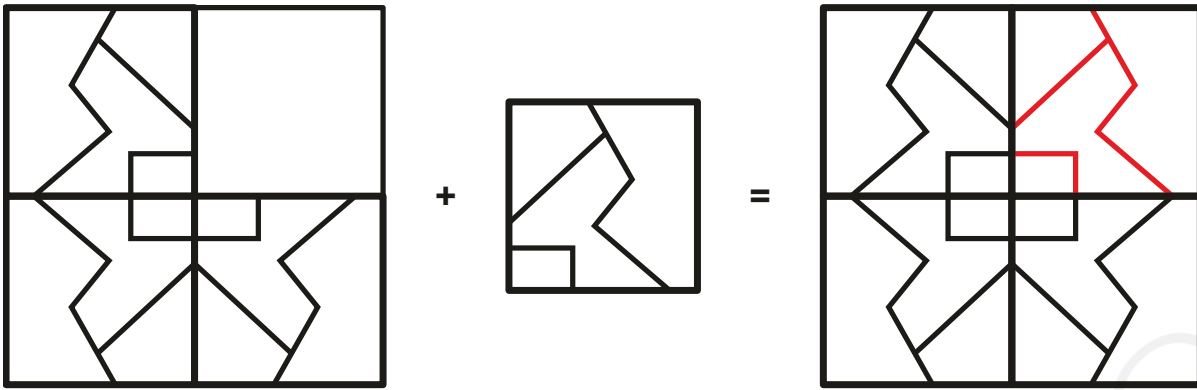

Hence, the **third option** is correct.

**Q.
144**

Directions: Select the option figure that will replace the question mark (?) in the figure given below to complete the pattern. (Rotation is not allowed.)

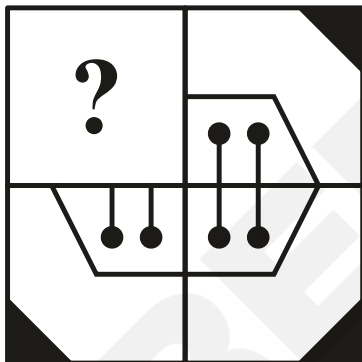

Option 1:

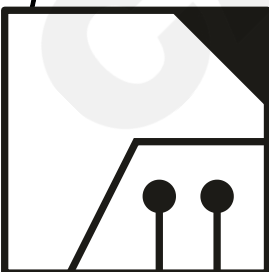

Option 2:

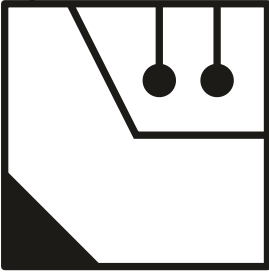

Option 3:

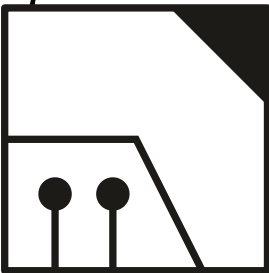

Option 4:

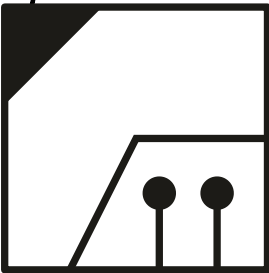

Correct Answer:

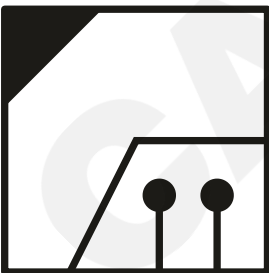

Solution:

On comparing the question figure and all the option figures, the following figure will combine and make the complete pattern -

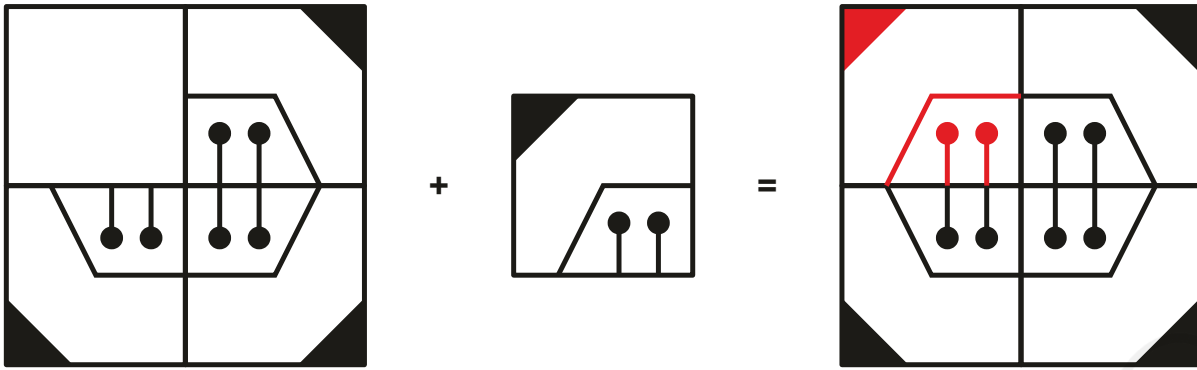

Hence, the **fourth option** is correct.

Q.
145

Directions: Select the option figure that will replace the question mark (?) in the figure given below to complete the pattern.

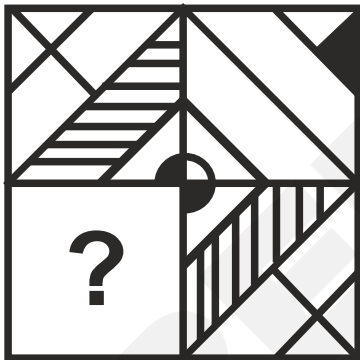

Option 1:



Option 2:



Option 3:

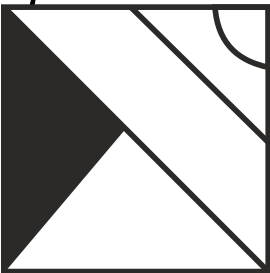

Option 4:



Correct Answer:



Solution:

On comparing the question figure and all the answer figures, the following figure will combine and make the complete pattern –

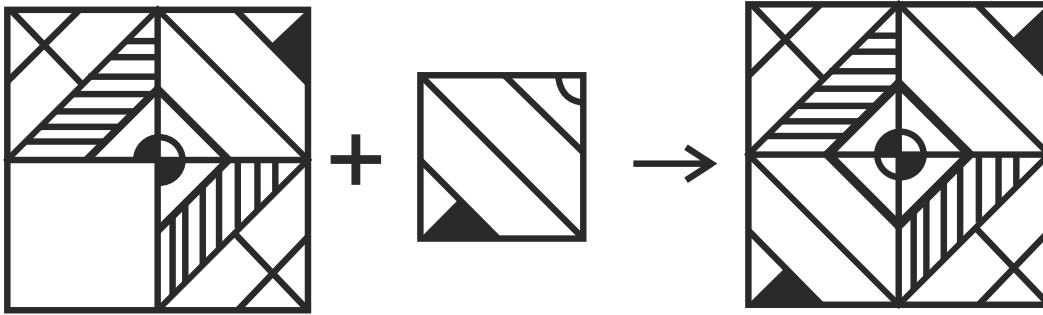

Hence, the **fourth option** is correct.

Q.
146

Directions: Which answer figure will complete the pattern in the question figure?

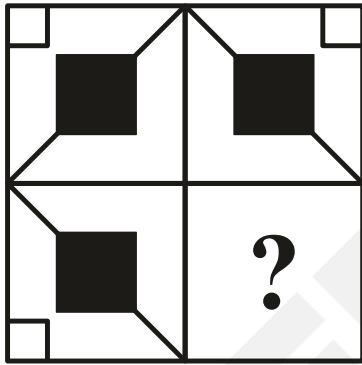

Option 1:

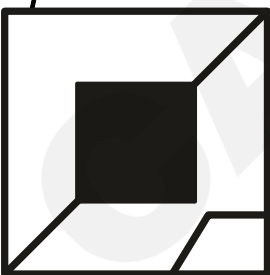

Option 2:

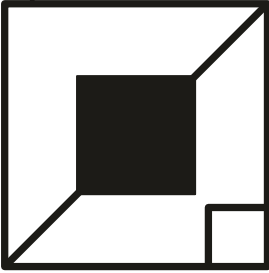

Option 3:

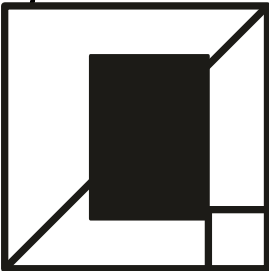

Option 4:

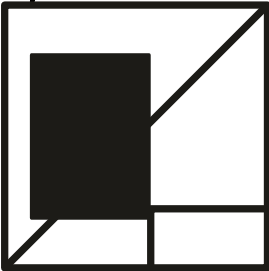

Correct Answer:

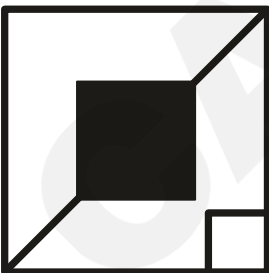

Solution:

On comparing the question figure and all the option figures, the following figure will combine and make the complete pattern -

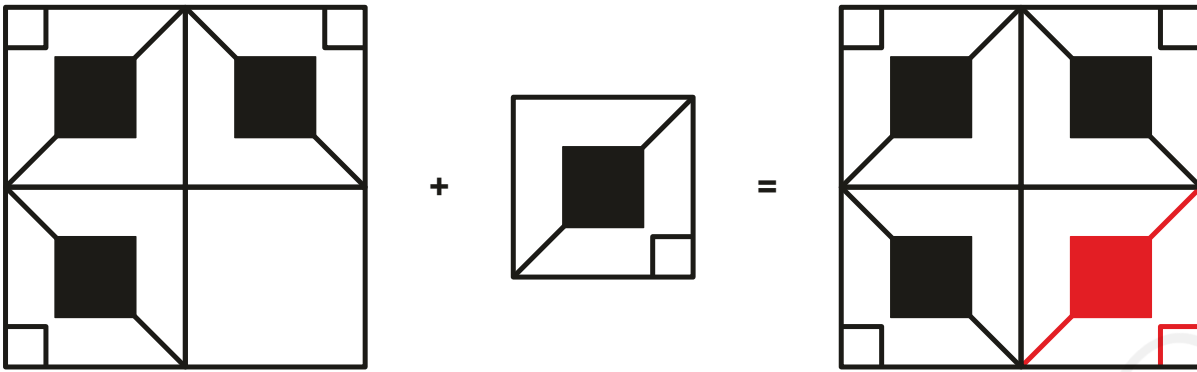

Hence, the **second option** is correct.

Q.
147

Directions: Which answer figure will complete the pattern in the question figure?

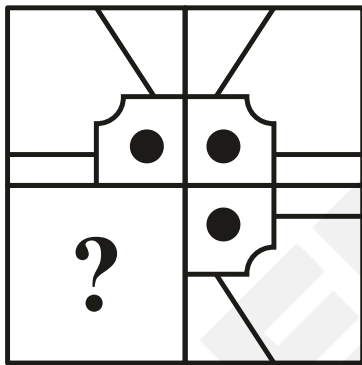

Option 1:

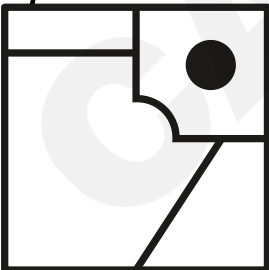

Option 2:

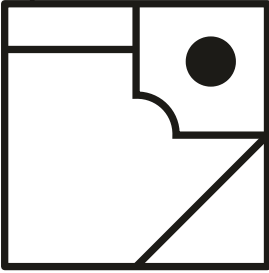

Option 3:

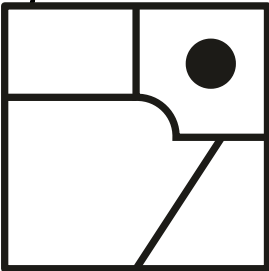

Option 4:

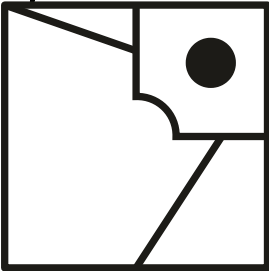

Correct Answer:

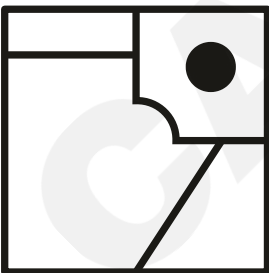

Solution:

On comparing the question figure and all the option figures, the following figure will combine and make the complete pattern -

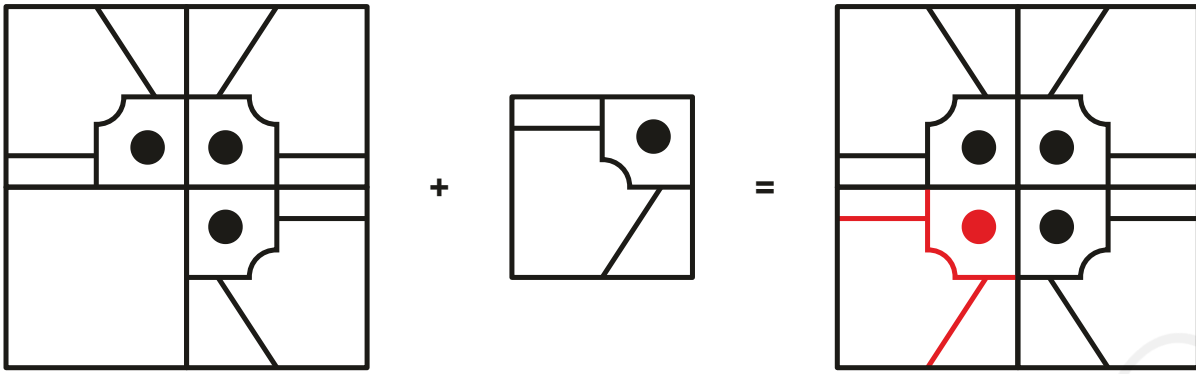

Hence, the **first option** is correct.

**Q.
148**

Directions: Select the option figure that will replace the question mark (?) in the figure given below to complete the pattern. (Rotation is not allowed.)

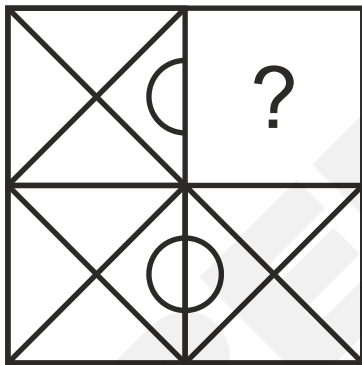

Option 1:

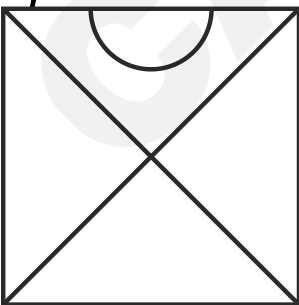

Option 2:

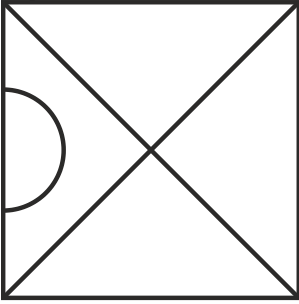

Option 3:

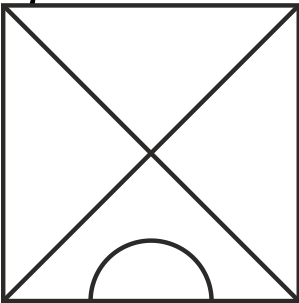

Option 4:

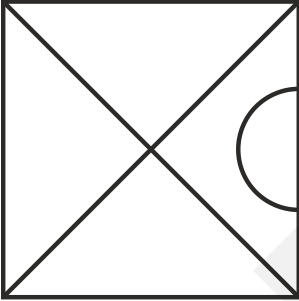

Correct Answer:

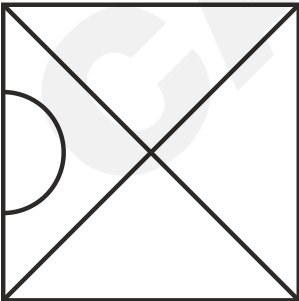

Solution:

On comparing the question figure and all the option figures, the following figure will combine and make the complete pattern -

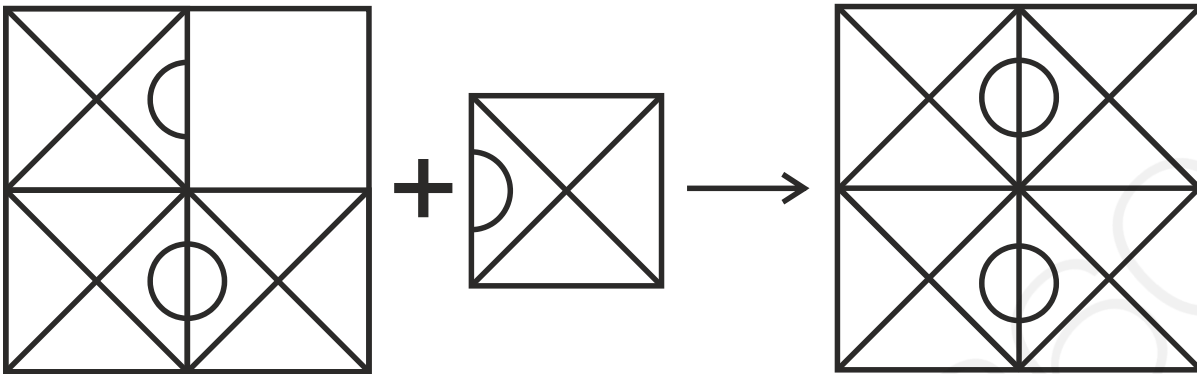

Hence, the **second option** is correct.

**Q.
149**

Directions: Select the option figure that will replace the question mark (?) in the figure given below to complete the pattern. (Rotation is not allowed.)

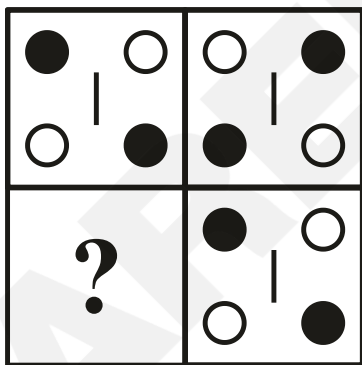

Option 1:

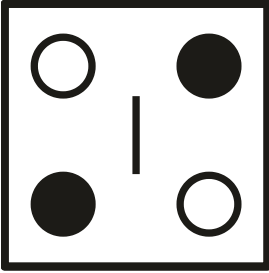

Option 2:

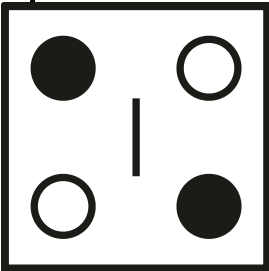

Option 3:

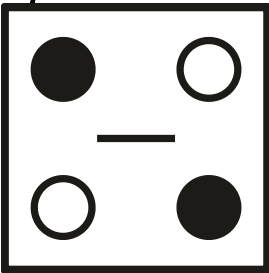

Option 4:

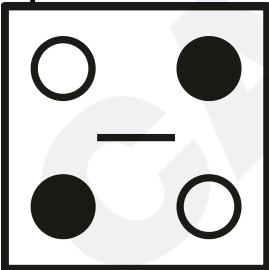

Correct Answer:

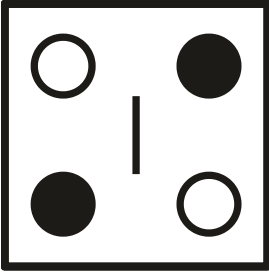

Solution:

On comparing the question figure and all the option figures, the following figure will combine and make the complete pattern -

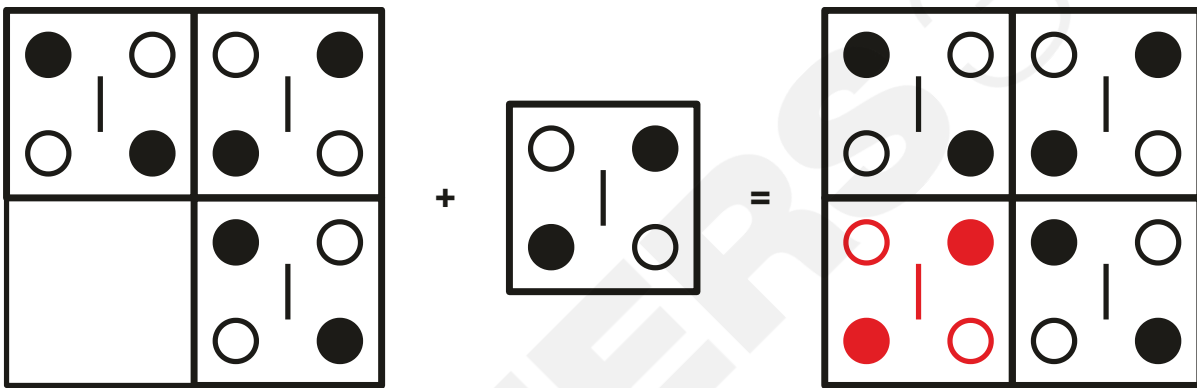

Hence, the **first option** is correct.

Q.
150

Directions: Select the option figure that will replace the question mark (?) in the figure given below to complete the pattern.

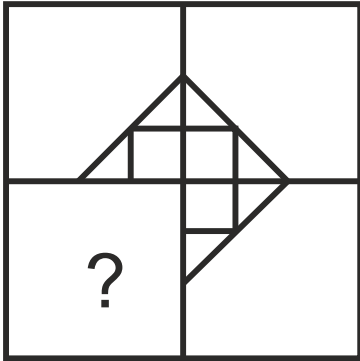

Option 1:

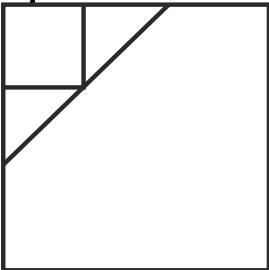

Option 2:

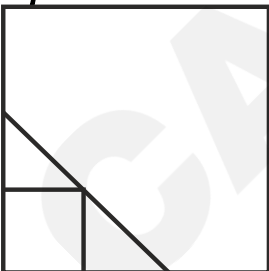

Option 3:

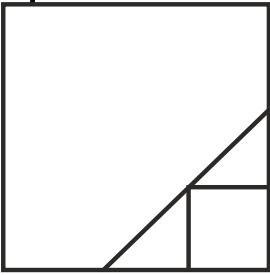

Option 4:

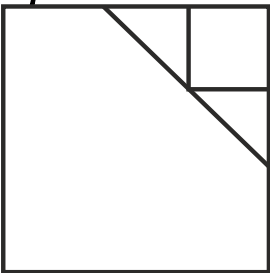

Correct Answer:

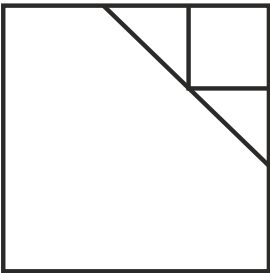

Solution:

On comparing the question figure and all the answer figures, the following figure will combine and make the complete pattern –

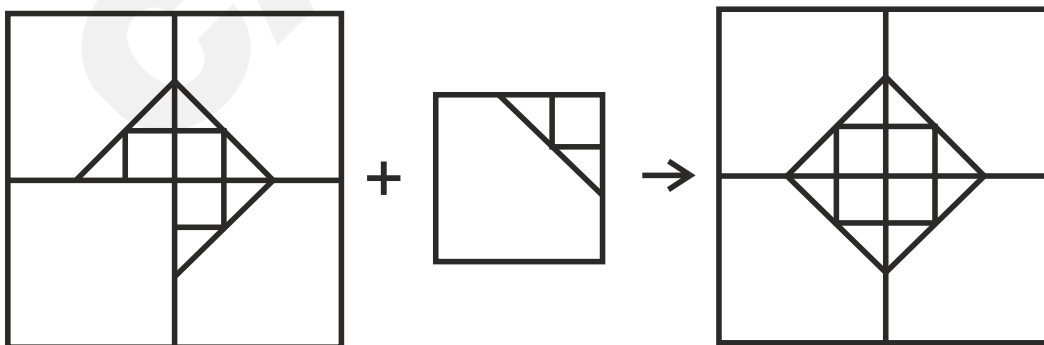

Hence, the **fourth option** is correct.

Q.
151

Directions: Select the option figure that will replace the question mark (?) in the figure given below to complete the pattern.

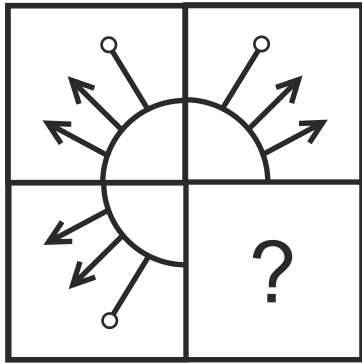

Option 1:

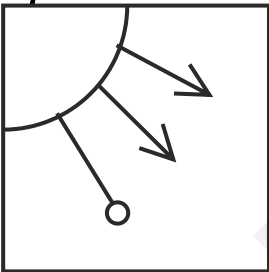

Option 2:

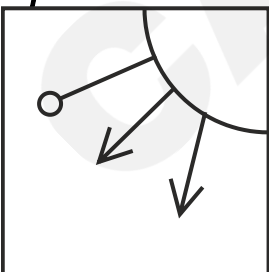

Option 3:

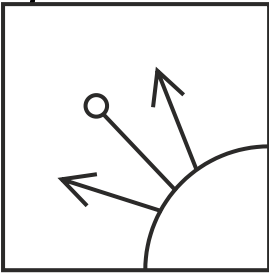

Option 4:

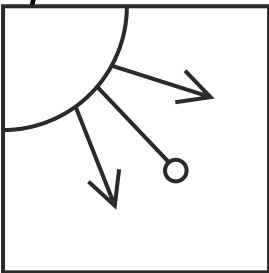

Correct Answer:

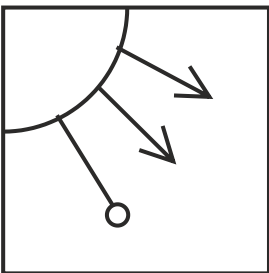

Solution:

On comparing the question figure and all the answer figures, the following figure will combine and make the complete pattern –

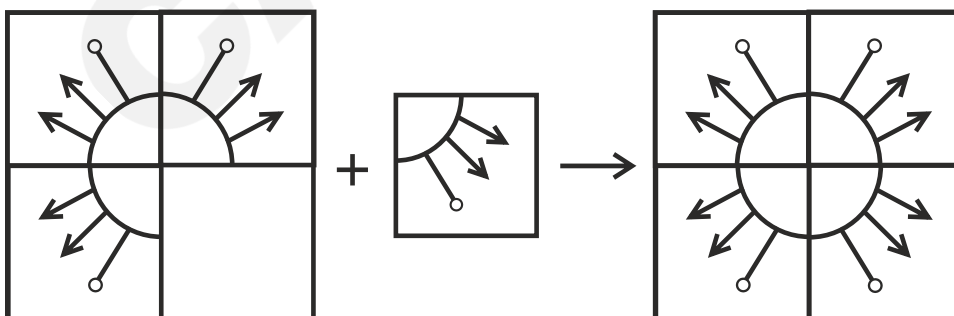

Hence, the **first option** is correct.

Q.
152

Directions: Which answer figure will complete the pattern in the question figure?

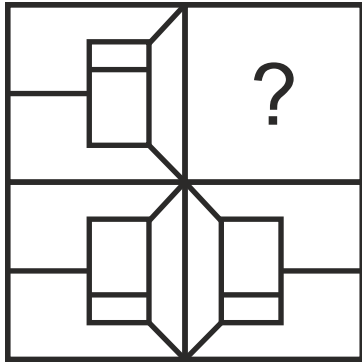

Option 1:

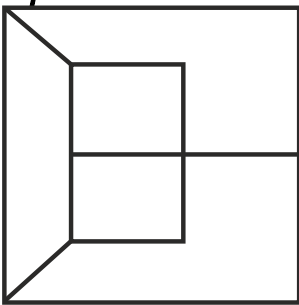

Option 2:

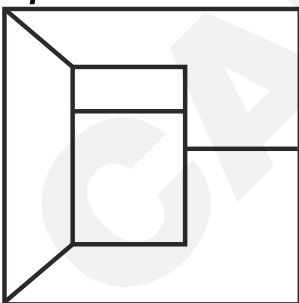

Option 3:

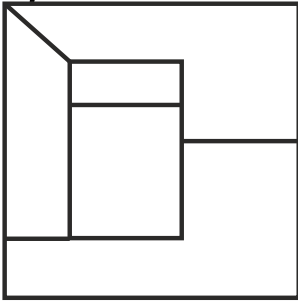

Option 4:

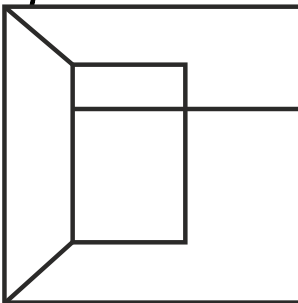

Correct Answer:

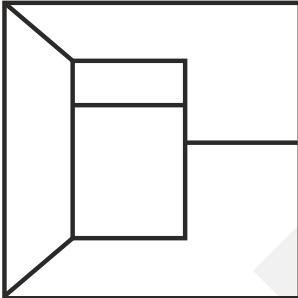

Solution:

On comparing the question figure and all the option figures, the following figure will combine and make the complete pattern –

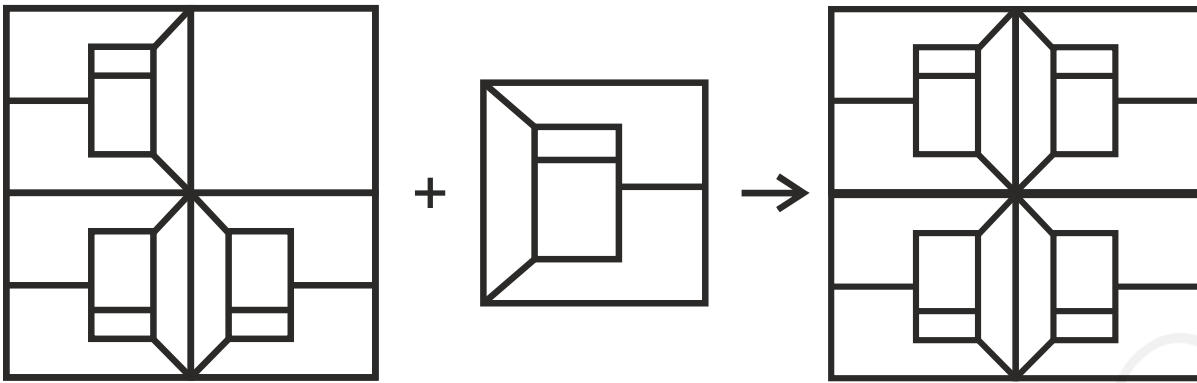

Hence, the **second option** is correct.

**Q.
153**

Directions: Which answer figure will complete the pattern in the question figure?

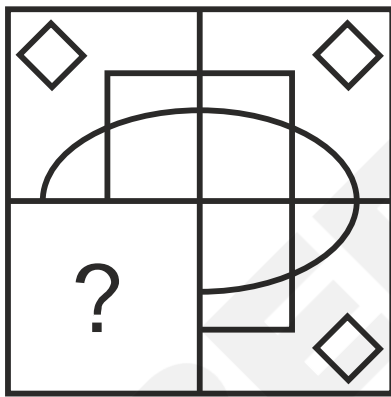

Option 1:

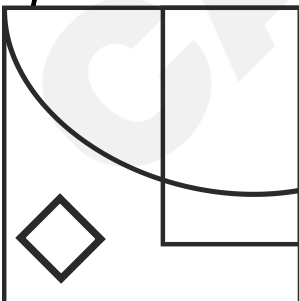

Option 2:

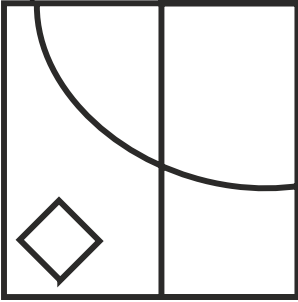

Option 3:

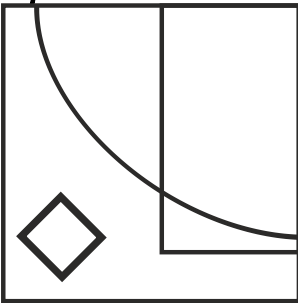

Option 4:

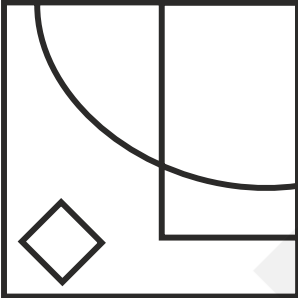

Correct Answer:

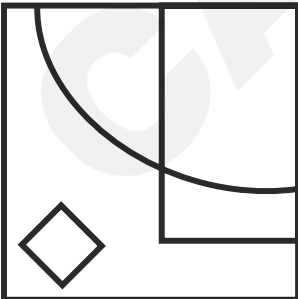

Solution:

On comparing the question figure and all the answer figures, the following figure will combine and make the complete pattern -

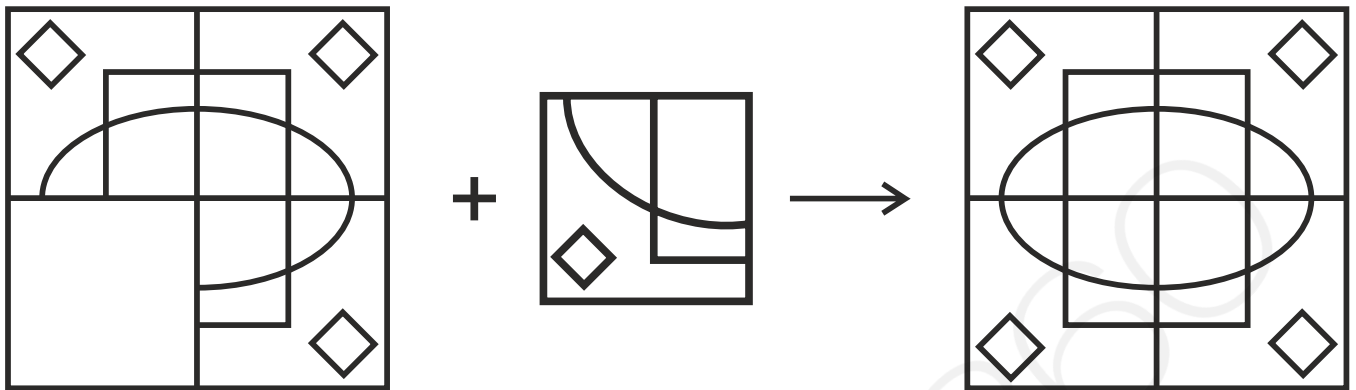

Hence, the **fourth option** is correct.

**Q.
154**

Directions: Which answer figure will complete the pattern in the question figure?

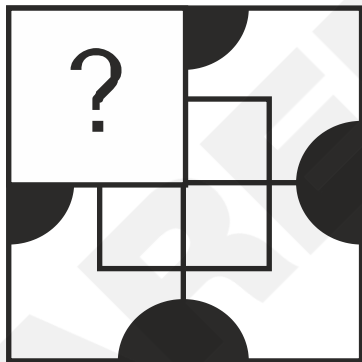

Option 1:

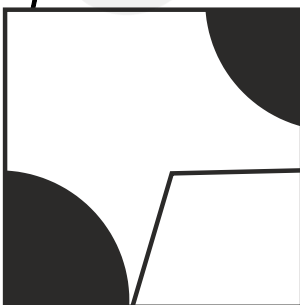

Option 2:

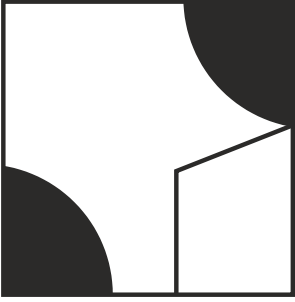

Option 3:

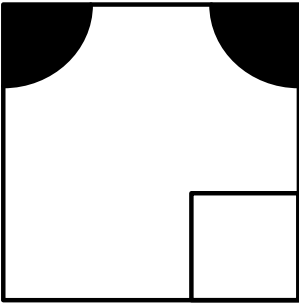

Option 4:



Correct Answer:



Solution:

On comparing the question figure and all the answer figures, the following figure will combine and make the complete pattern -

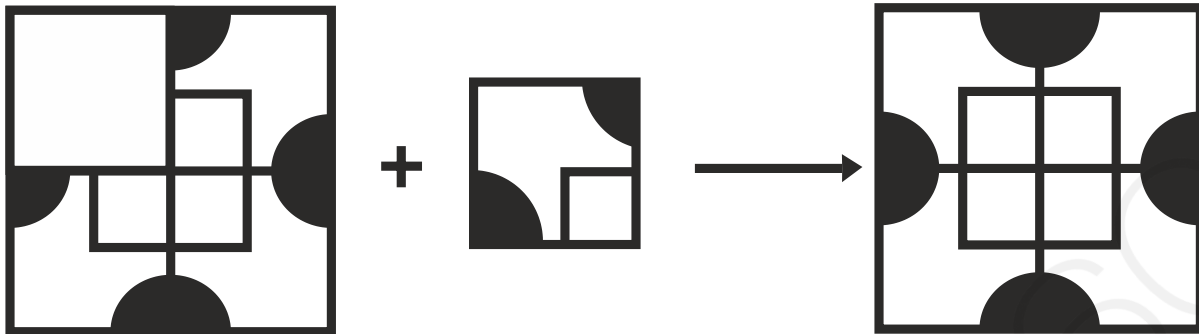

Hence, the **fourth option** is correct.

**Q.
155**

Directions: Select the options figure that will replace the question mark (?) in the figure given below to complete the pattern. (Rotation is not allowed.)

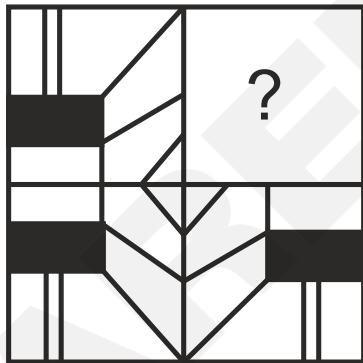

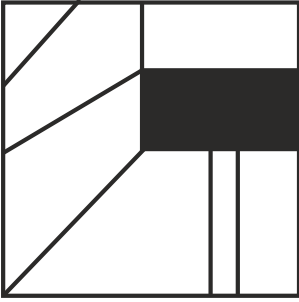
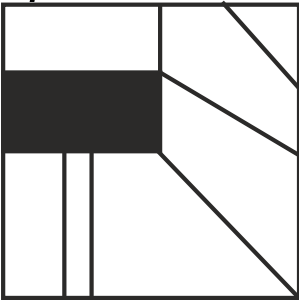
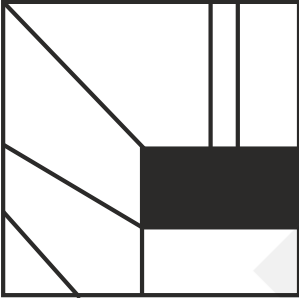
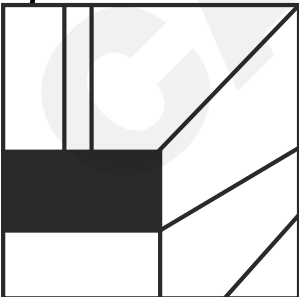
Option 1:**Option 2:****Option 3:****Option 4:**

Correct Answer:

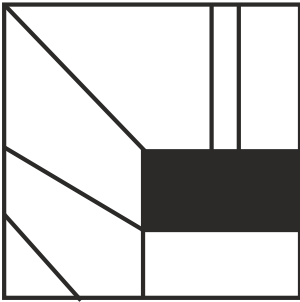

Solution:

On comparing the question figure and all the option figures, the following figure will combine and make the complete pattern -

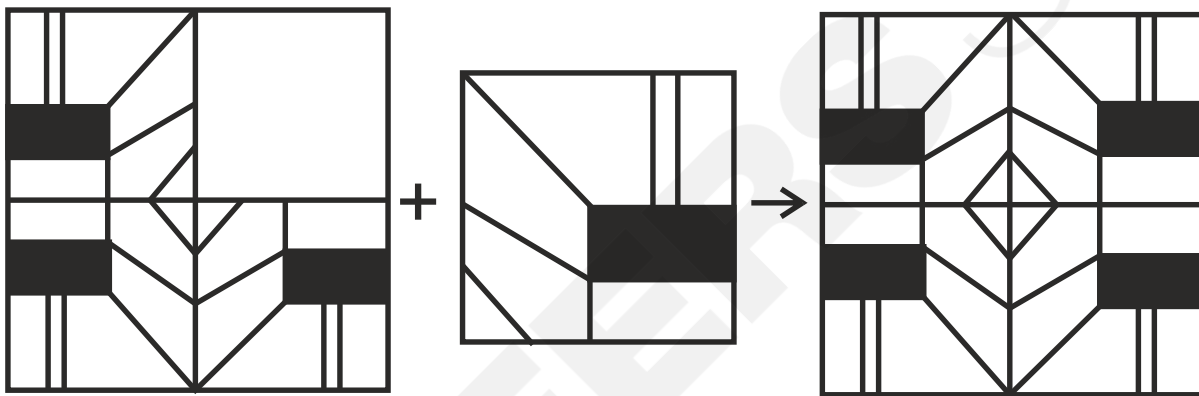

Hence, the **third option** is correct.

Q.
156

Directions: Which answer figure will complete the pattern in the question figure?

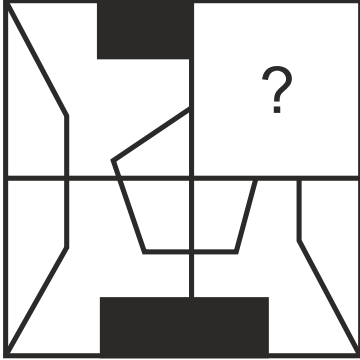

Option 1:



Option 2:

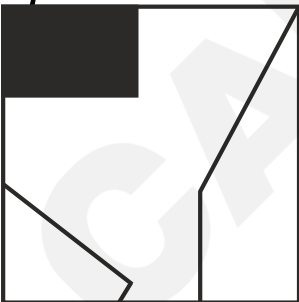

Option 3:

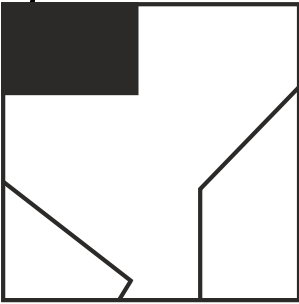

Option 4:

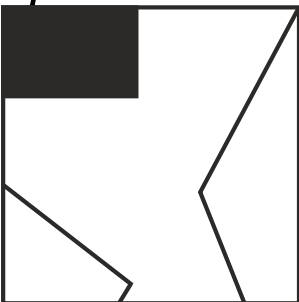

Correct Answer:



Solution:

On comparing the question figure and all the answer figures, the following figure will combine and make the complete pattern –

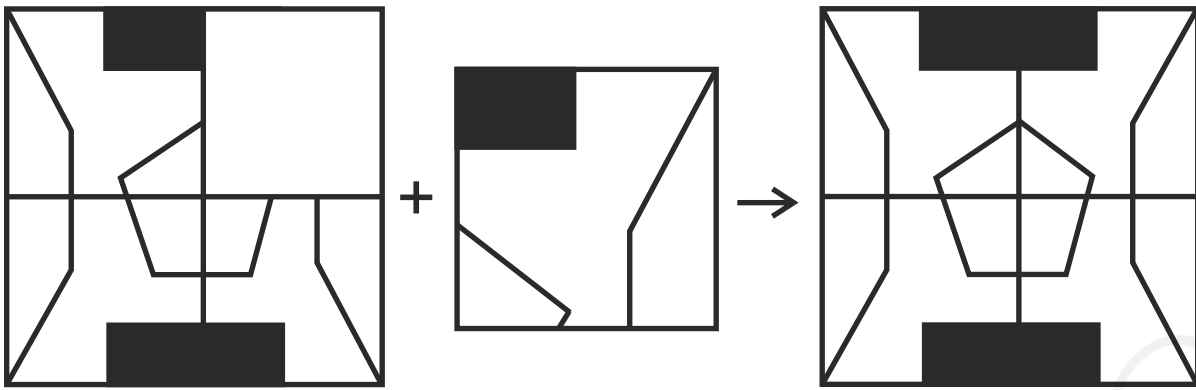

Hence, the **second option** is correct.

**Q.
157**

Directions: Select the option figure that will replace the question mark (?) in the figure given below to complete the pattern (Rotation is not allowed).

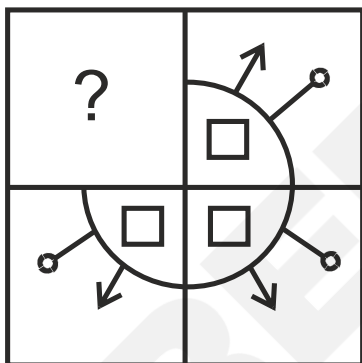

Option 1:

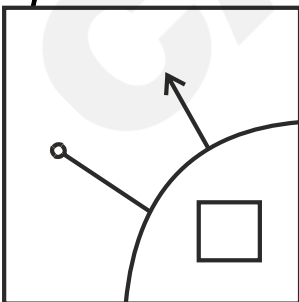

Option 2:

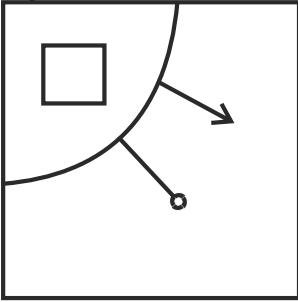

Option 3:

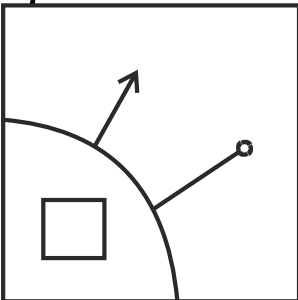

Option 4:

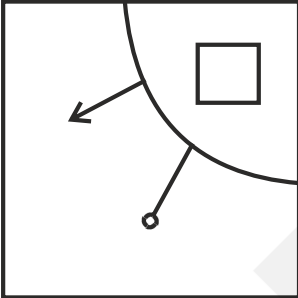

Correct Answer:

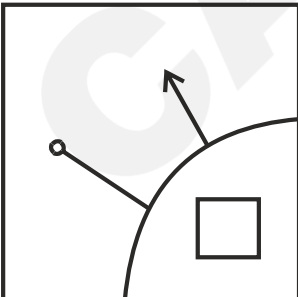

Solution:

On comparing the question figure and all the answer figures, the following figure will combine and make the complete pattern -

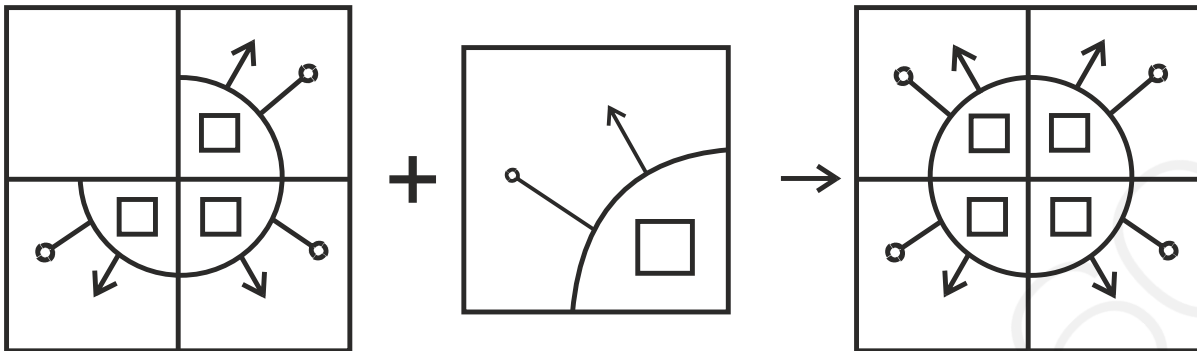

Hence, the **first option** is correct.

**Q.
158**

Directions: Select the option figure that will replace the question mark (?) in the figure given below to complete the pattern. (Rotation is not allowed.)

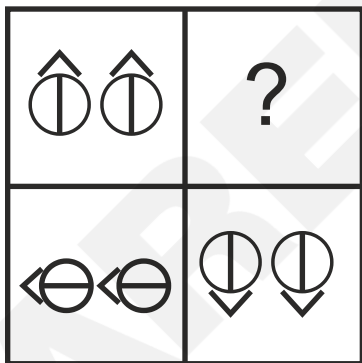

Option 1:

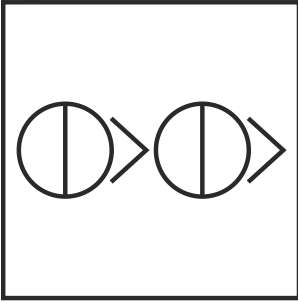

Option 2:

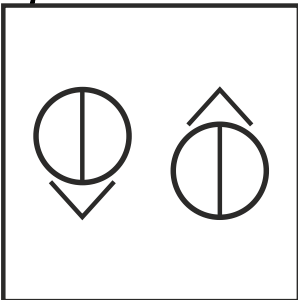

Option 3:

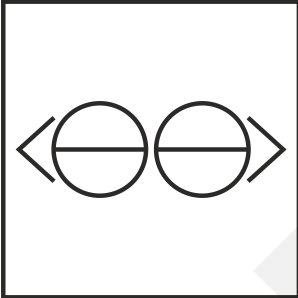

Option 4:

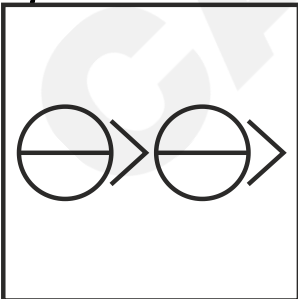

Correct Answer:

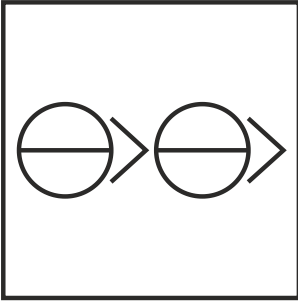

Solution:

On comparing the question figure and all the answer figures, the following figure will combine and make the complete pattern -

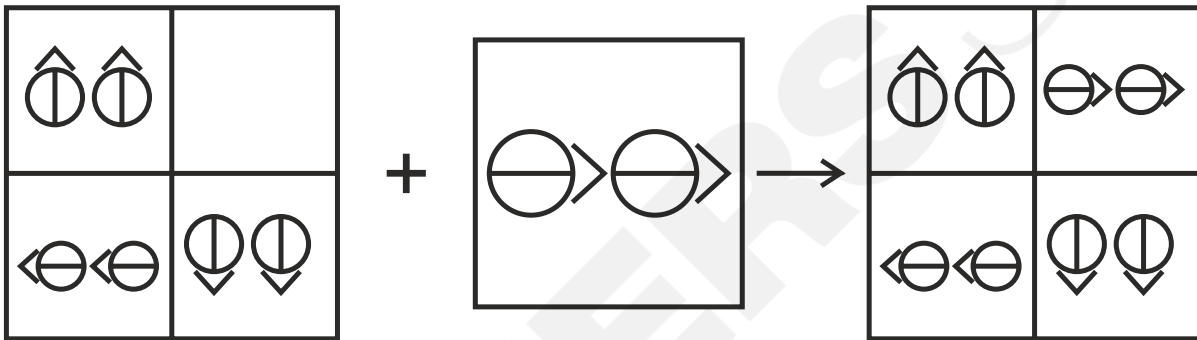

The figure inside the box is being rotated by 90 degrees in the clockwise direction.

Hence, the **fourth option** is correct.

Q.
159

Directions: Which answer figure will complete the pattern in the question figure?

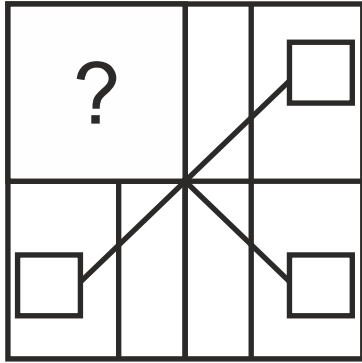

Option 1:

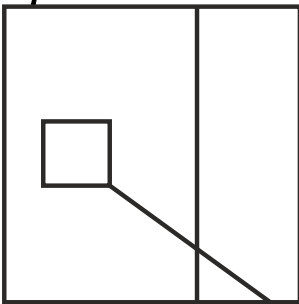

Option 2:

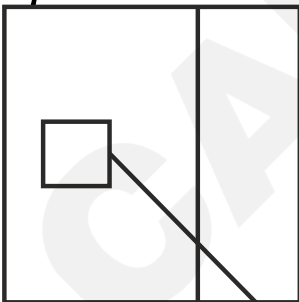

Option 3:

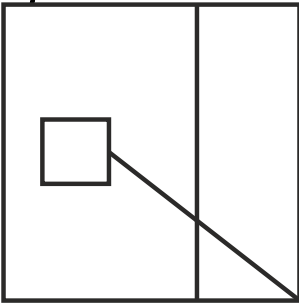

Option 4:

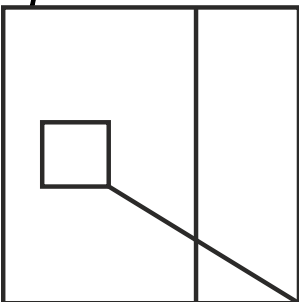

Correct Answer:

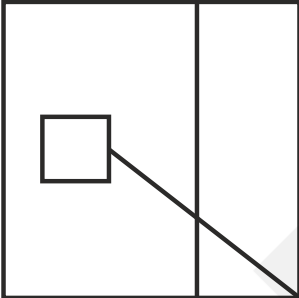

Solution:

On comparing the question figure and all the option figures, the following figure will combine and make the complete pattern -

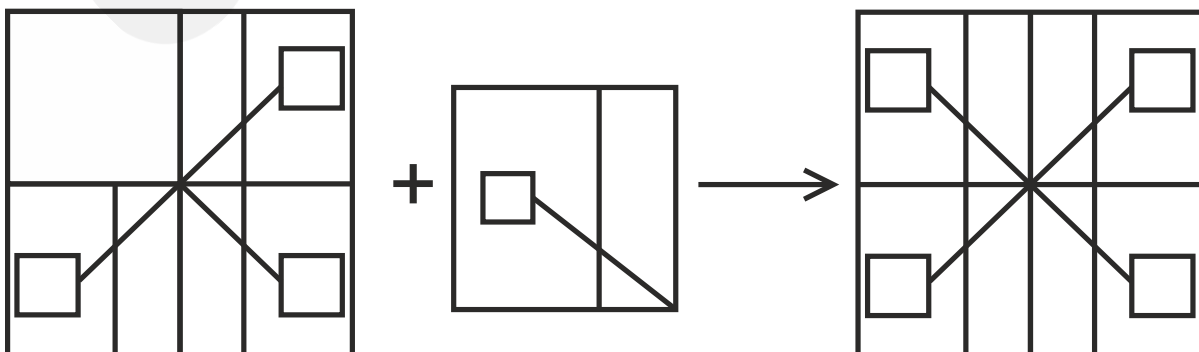

Hence, the **third option** is correct.

Q.
160

Directions: Select the option figure that will replace the question mark (?) in the figure given below to complete the pattern. (Rotation is not allowed.)

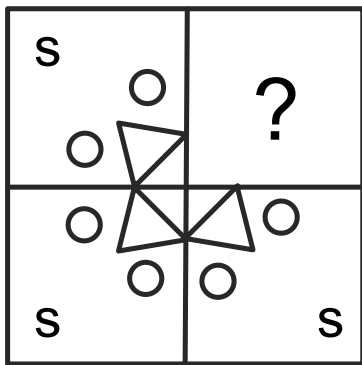

Option 1:

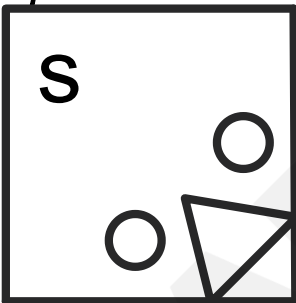

Option 2:

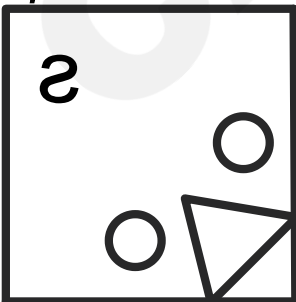

Option 3:

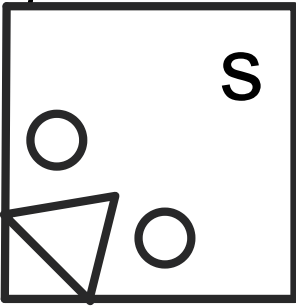

Option 4:

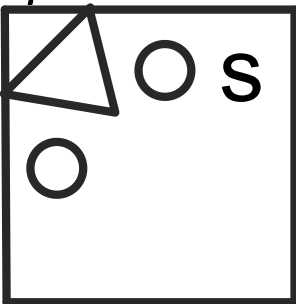

Correct Answer:

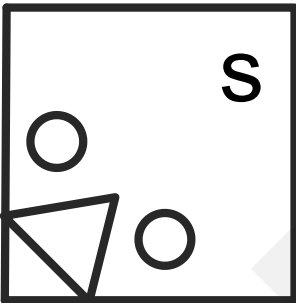

Solution:

On comparing the question figure and all the answer figures, the following figure will combine and make the complete pattern -

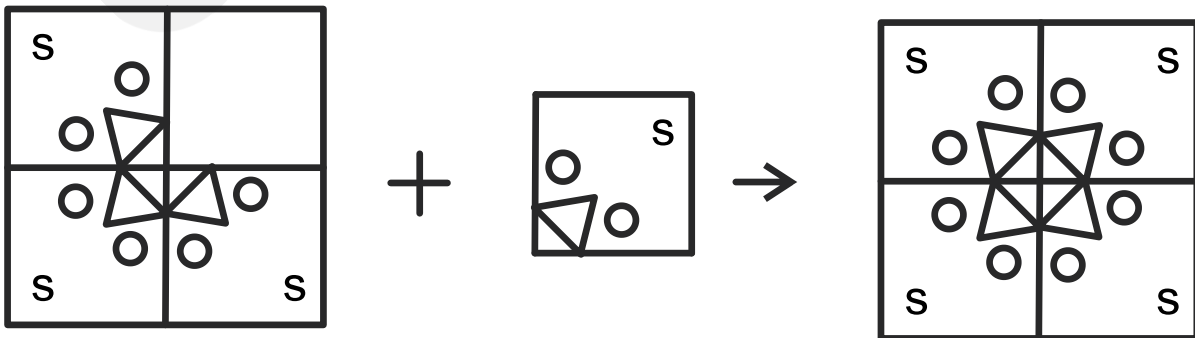

Hence, the **third option** is correct.

**Q.
161**

Directions: Which answer figure will complete the pattern in the question figure?

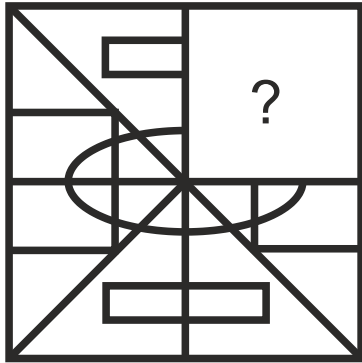

Option 1:

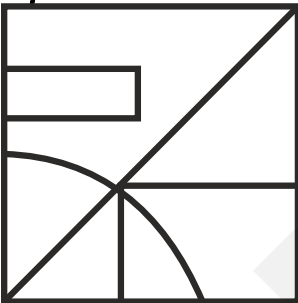

Option 2:

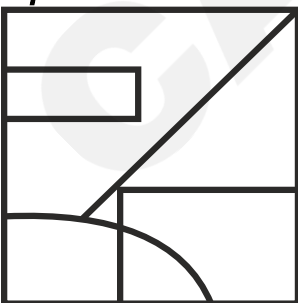

Option 3:

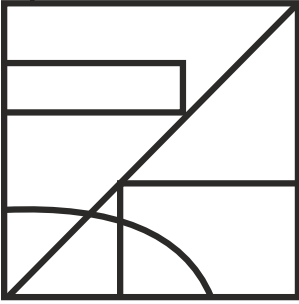

Option 4:

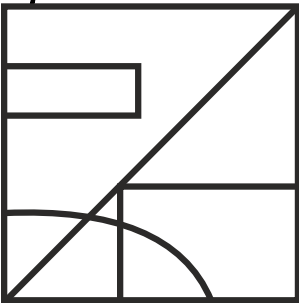

Correct Answer:

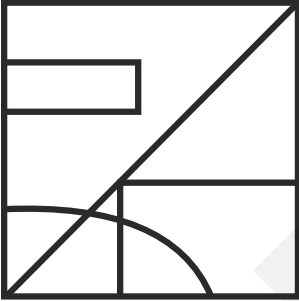

Solution:

On comparing the question figure and all the answer figures, the following figure will combine and make the complete pattern –

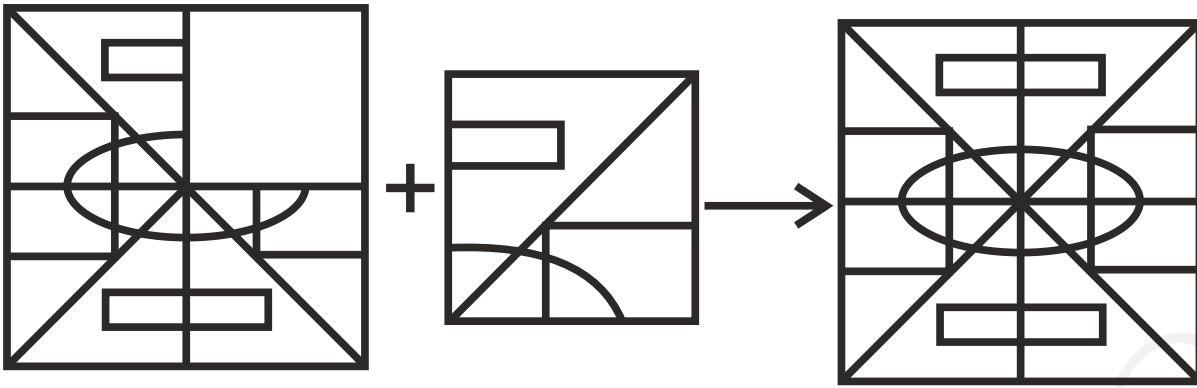

Hence, the **fourth option** is correct.

**Q.
162**

Directions: Select the figure from the options that can replace the question mark (?) and complete the pattern.

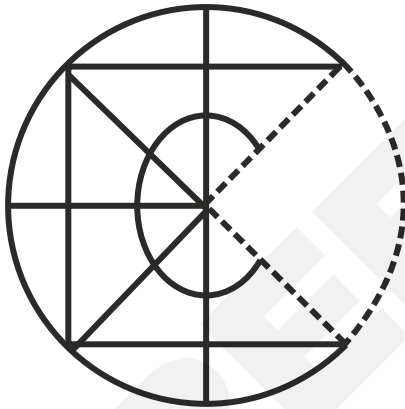

Option 1:

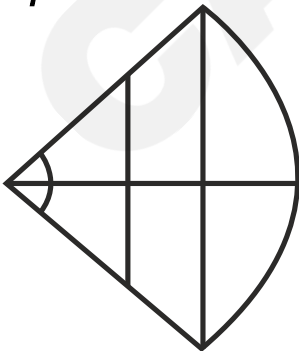

Option 2:

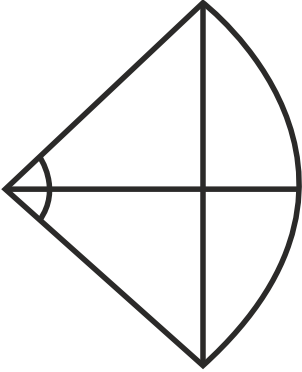

Option 3:

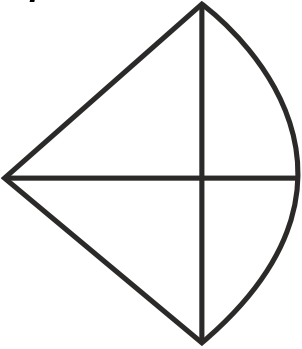

Option 4:

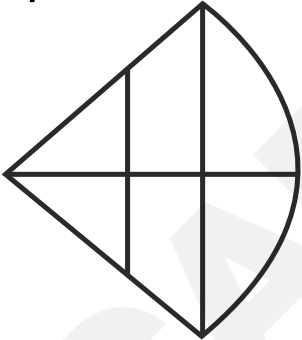

Correct Answer:

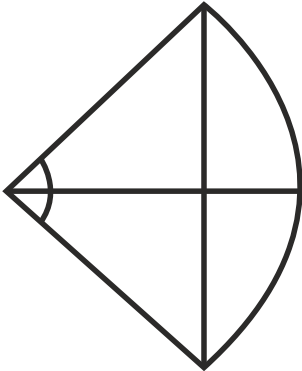

Solution:

On comparing the question figure and all the answer figures, the following figure will combine and make the complete pattern -

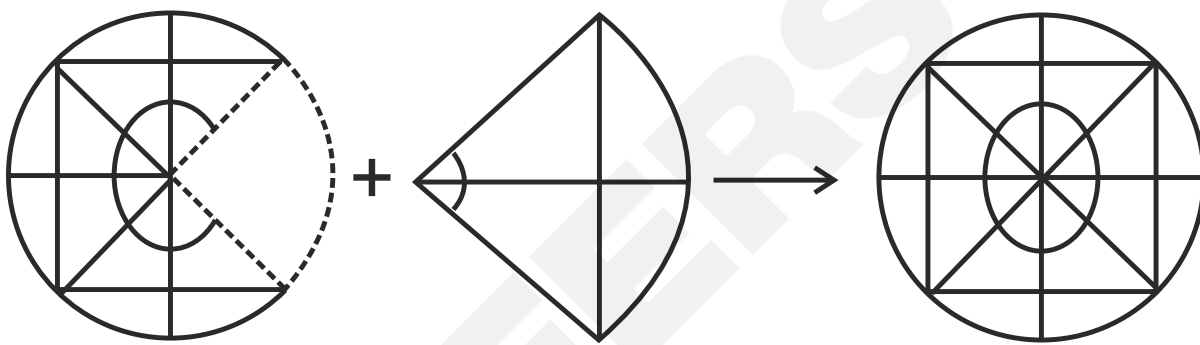

Hence, the **second option** is correct.

Q.
163

Directions: Select the figure from the options that can replace the question mark (?) and complete the given pattern.

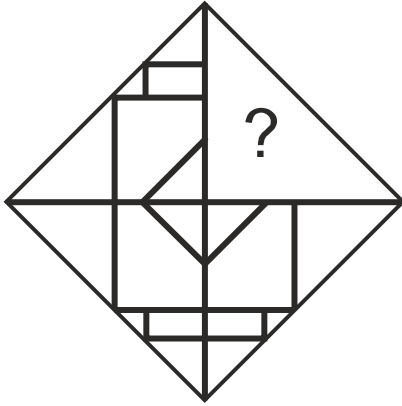

Option 1:

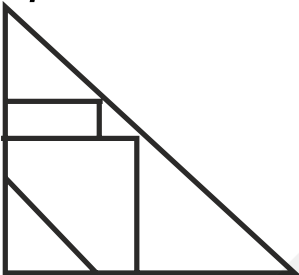

Option 2:

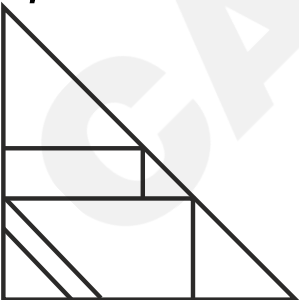

Option 3:

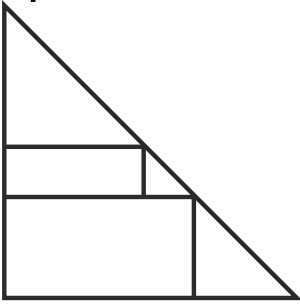

Option 4:

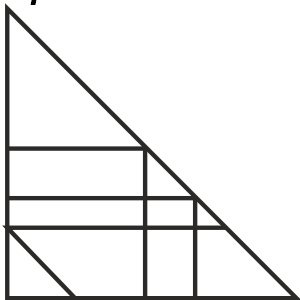

Correct Answer:

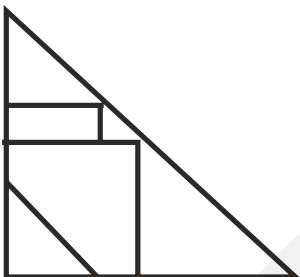

Solution:

On comparing the question figure and all the answer figures, the following figure will combine and make the complete pattern -

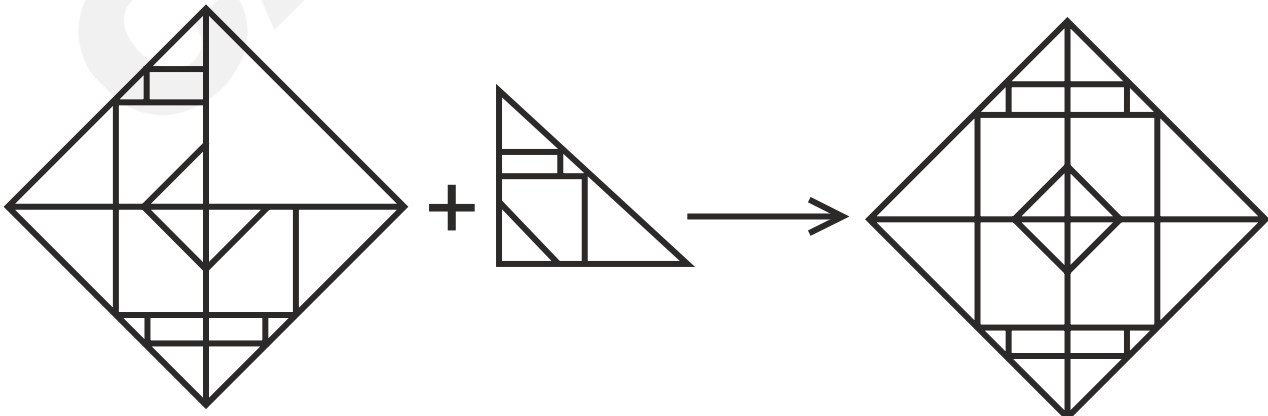

Hence, the **first option** is correct.

**Q.
164**

Directions: Select the figure that will replace the question mark (?) in the given figure to complete the pattern.

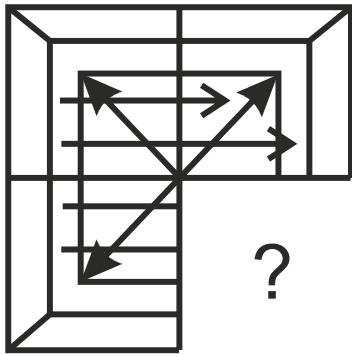

Option 1:

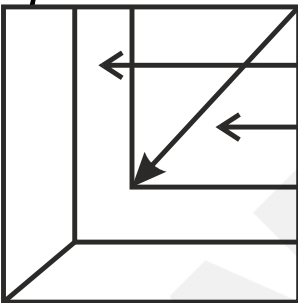

Option 2:

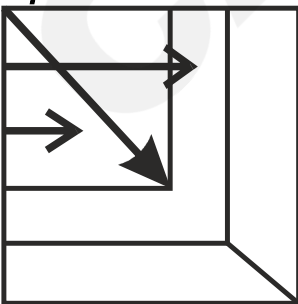

Option 3:

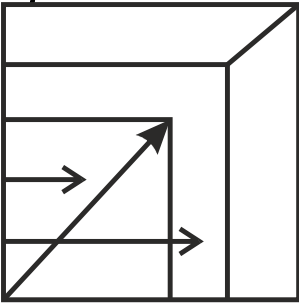

Option 4:

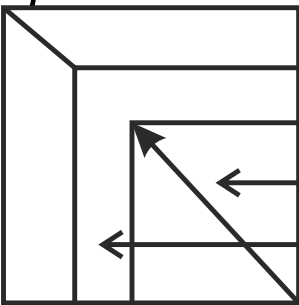

Correct Answer:

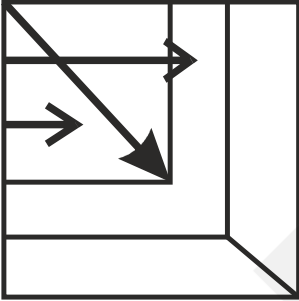

Solution:

On comparing the question figure and all the option figures, the following figure will combine and make the complete pattern -

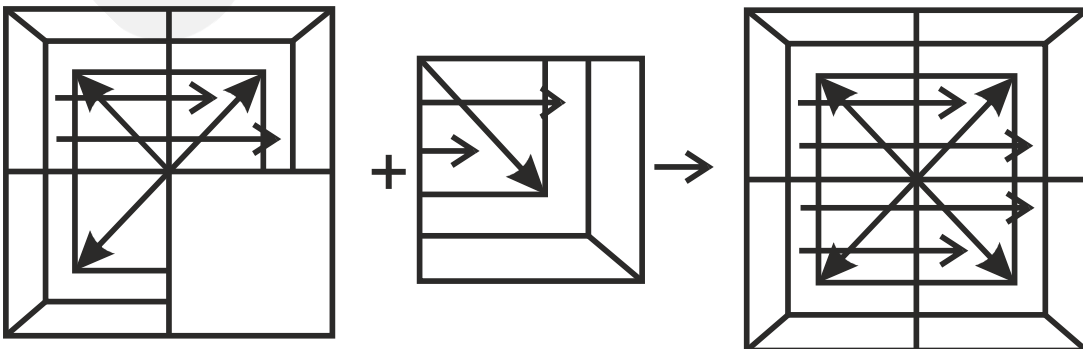

Hence, the **second option** is correct.

Q.
165

Directions: Select the option that will replace the question mark (?) in the figure given below to complete the pattern.

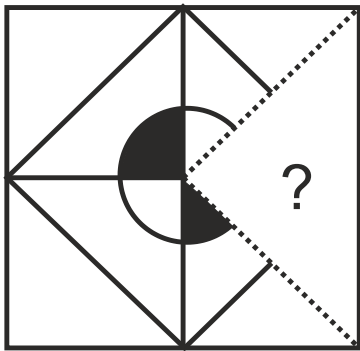

Option 1:

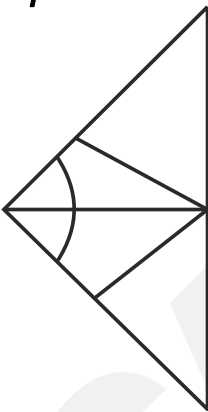

Option 2:

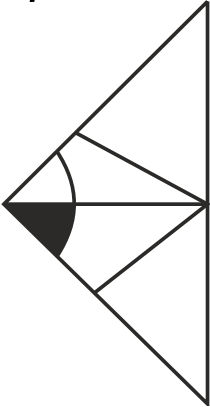

Option 3:

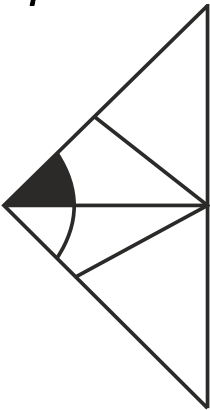

Option 4:

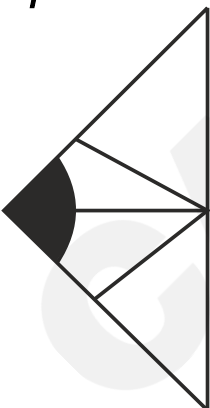

Correct Answer:

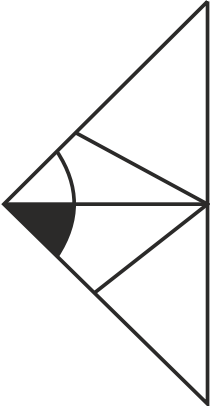

Solution:

On comparing the question figure and all the answer figures, the following figure will combine and make the complete pattern -

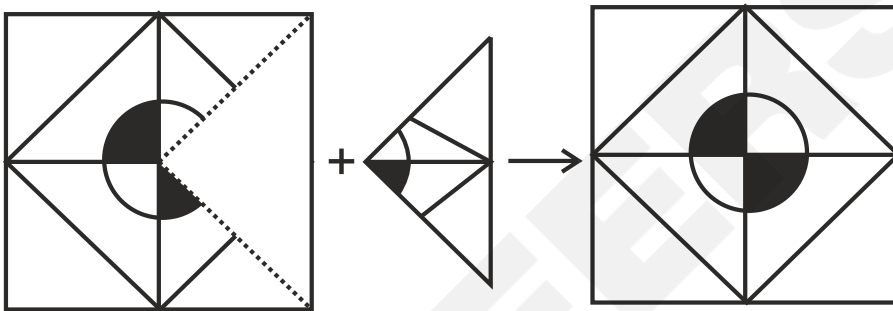

Hence, the **second option** is correct

Q.
166

Directions: Select the option that will replace the question mark (?) in the figure given below to complete the pattern.

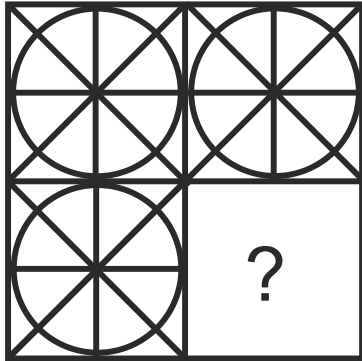

Option 1:

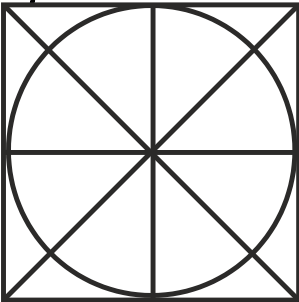

Option 2:

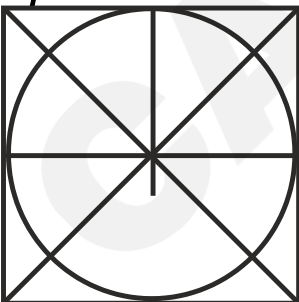

Option 3:

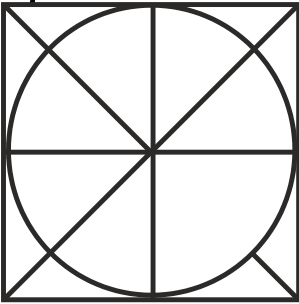

Option 4:

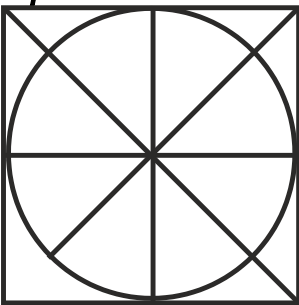

Correct Answer:

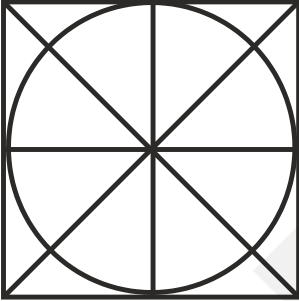

Solution:

On comparing the question figure and all the answer figures, the following figure will combine and make the complete pattern -

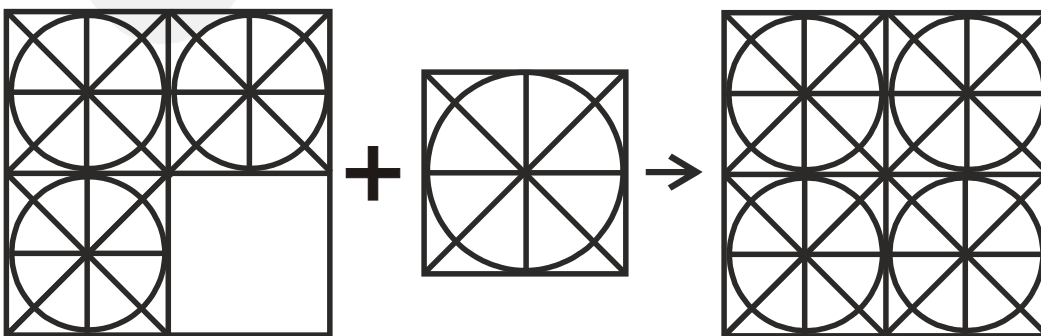

Hence, the **first option** is correct.

**Q.
167**

Directions: Select the figure from the options that can replace the question mark (?) and complete the pattern.

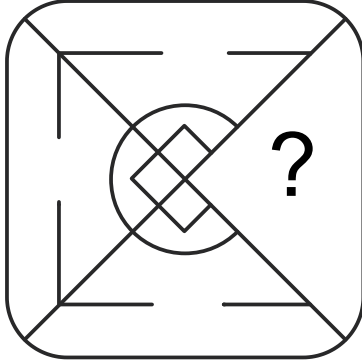

Option 1:

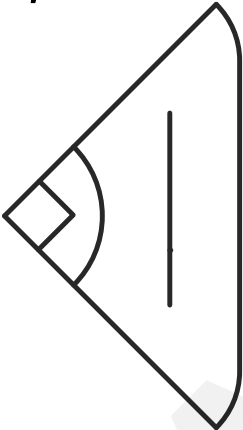

Option 2:

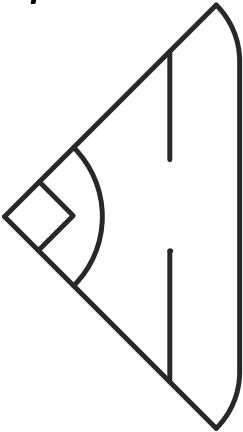

Option 3:

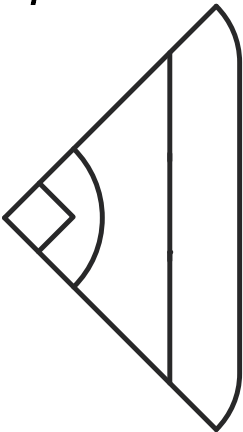

Option 4:

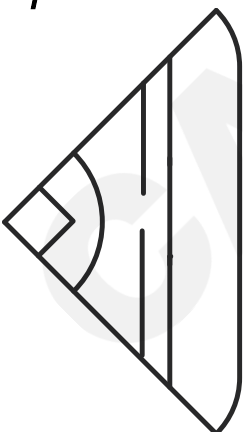

Correct Answer:

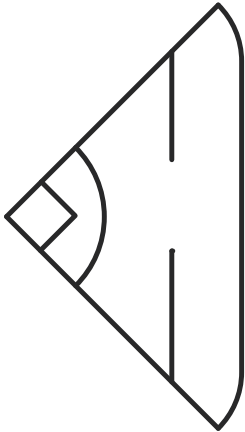

Solution:

On comparing the question figure and all the option figures, the following figure will combine and make the complete pattern -

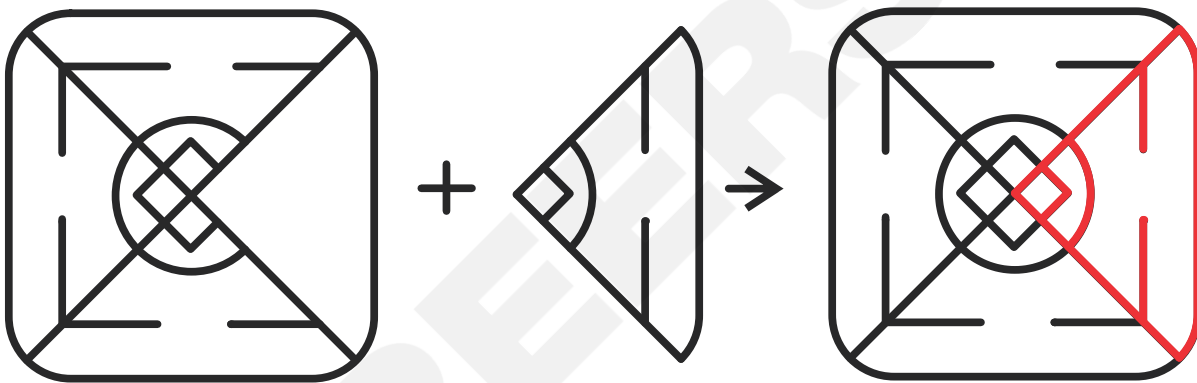

Hence, the **second option** is correct.

Q.
168

Directions: Select the option figure that will replace the question mark (?) in the given figure to complete the pattern.

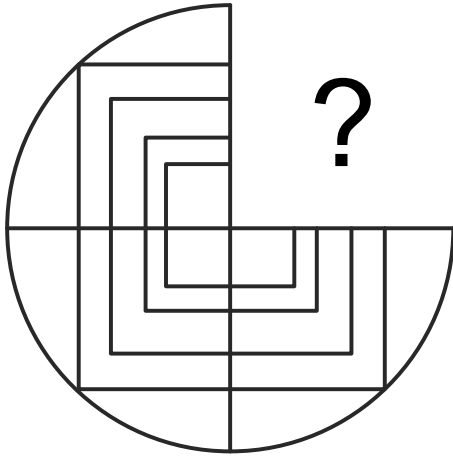

Option 1:

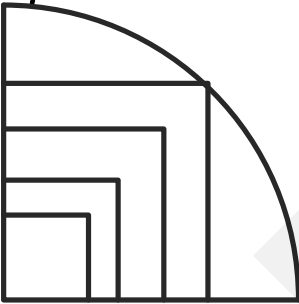

Option 2:

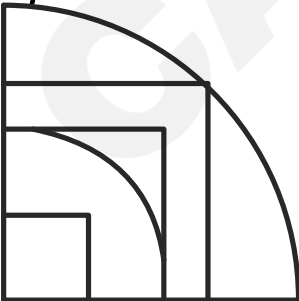

Option 3:

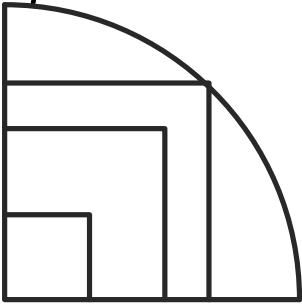

Option 4:

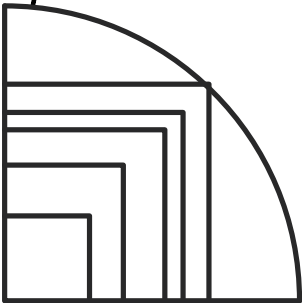

Correct Answer:

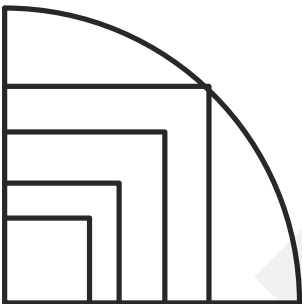

Solution:

On comparing the question figure and all the option figures, the following figure will combine and make the complete pattern -

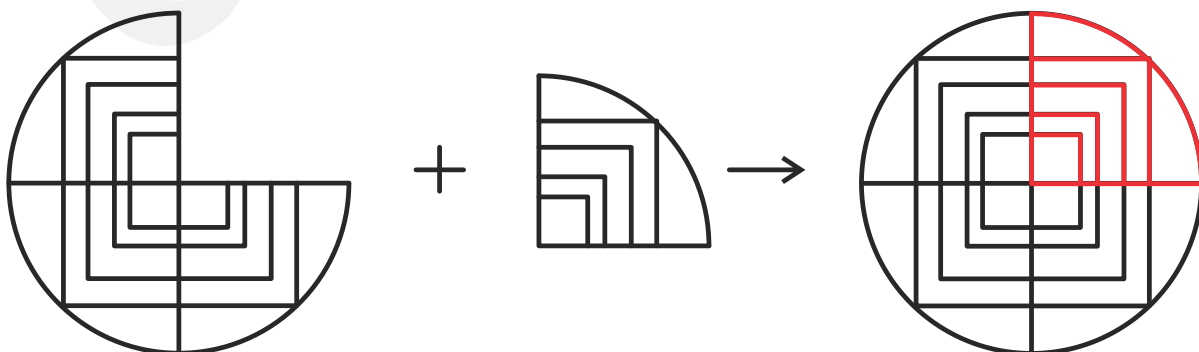

Hence, the **first option** is correct.

**Q.
169**

Directions: Select the figure that will replace the question mark (?) in the given figure to complete the pattern.

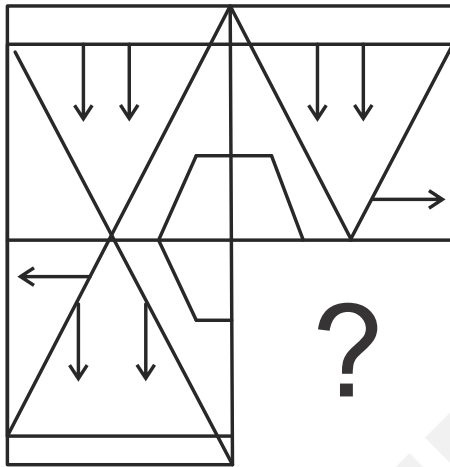

Option 1:

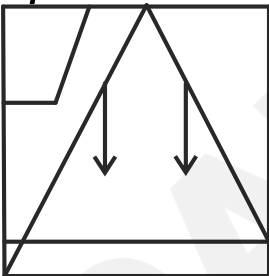

Option 2:

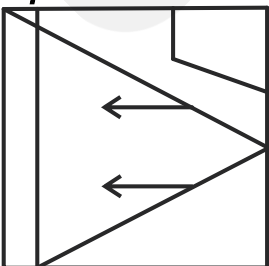

Option 3:

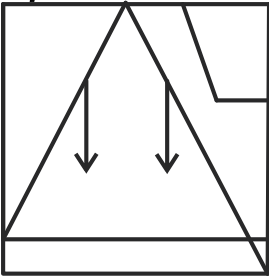

Option 4:

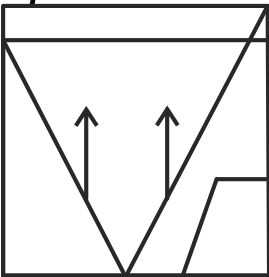

Correct Answer:

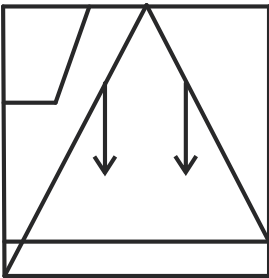

Solution:

On comparing the question figure and all the answer figures, the following figure will combine and make the complete pattern -

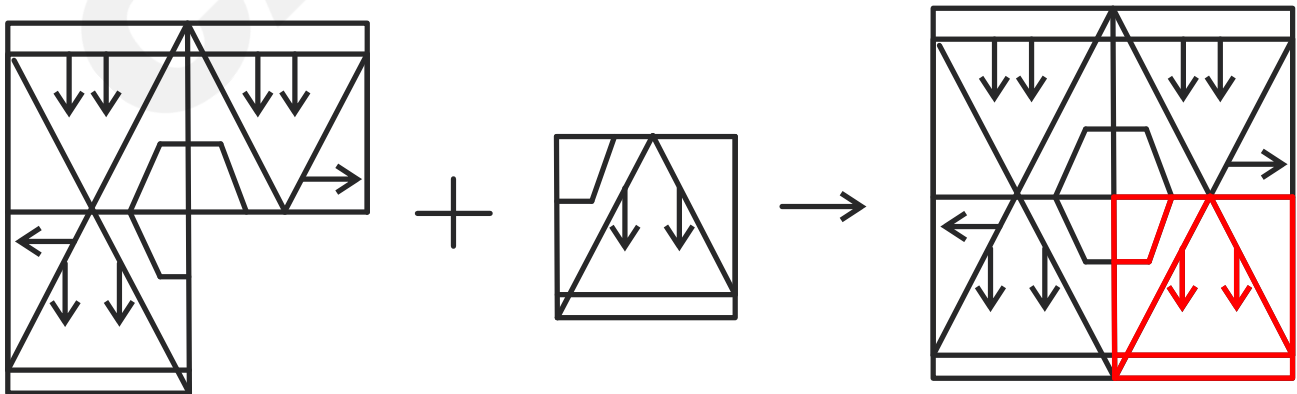

Hence, the **first option** is correct.

Q.
170

Directions: Select the figure from the options that can replace the question mark (?) and complete the pattern.

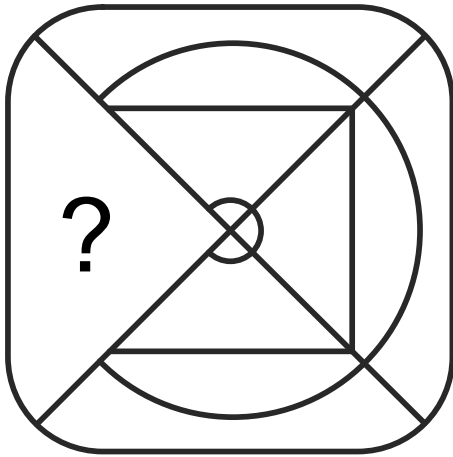

Option 1:

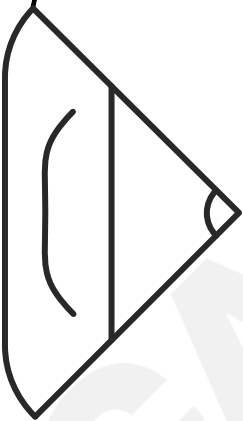

Option 2:

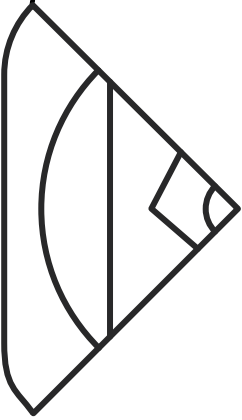

Option 3:

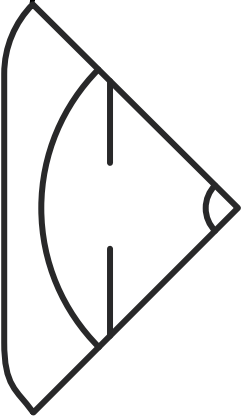

Option 4:

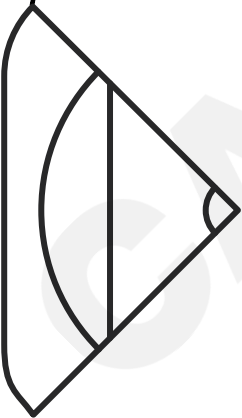

Correct Answer:

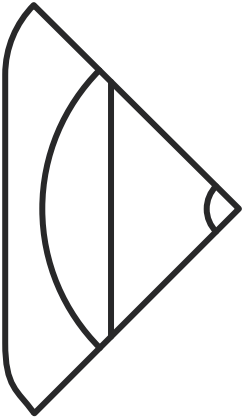

Solution:

On comparing the question figure and all the option figures, the following figure will combine and make the complete pattern -

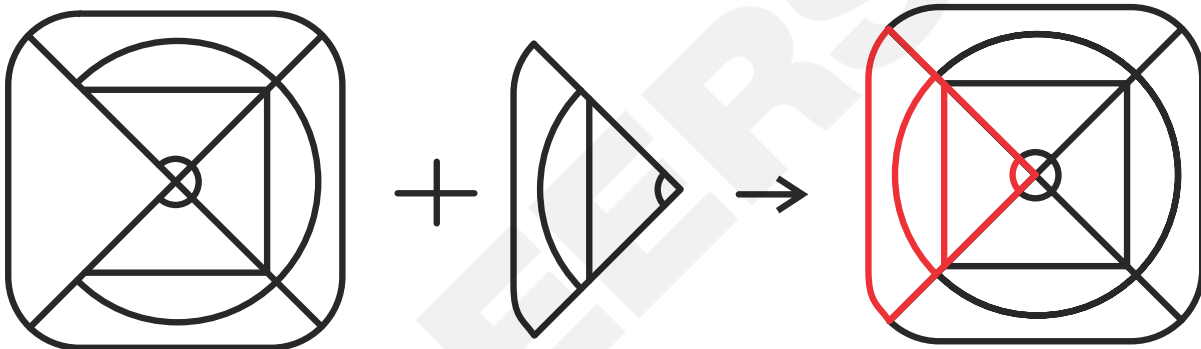

Hence, the **fourth option** is correct.

Q.
171

Directions: Select the option that will replace the question mark (?) in the figure given below to complete the pattern.

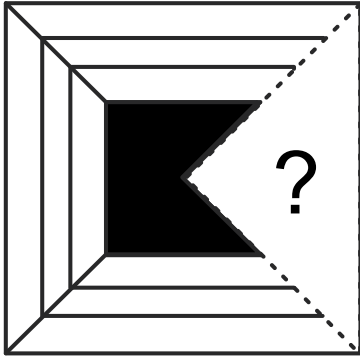

Option 1:

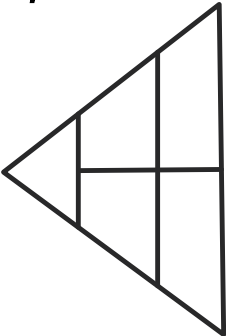

Option 2:

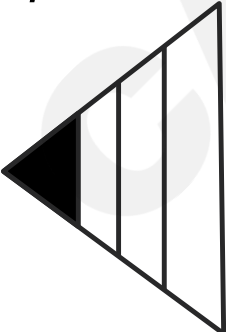

Option 3:

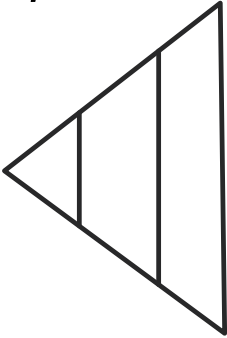

Option 4:

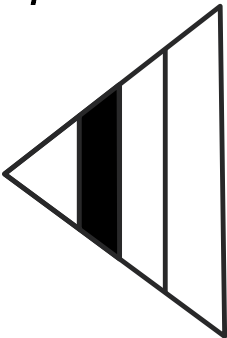

Correct Answer:

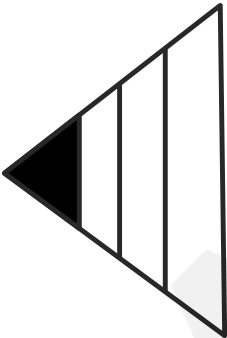

Solution:

On comparing the question figure and all the answer figures, the following figure will combine and make the complete pattern -

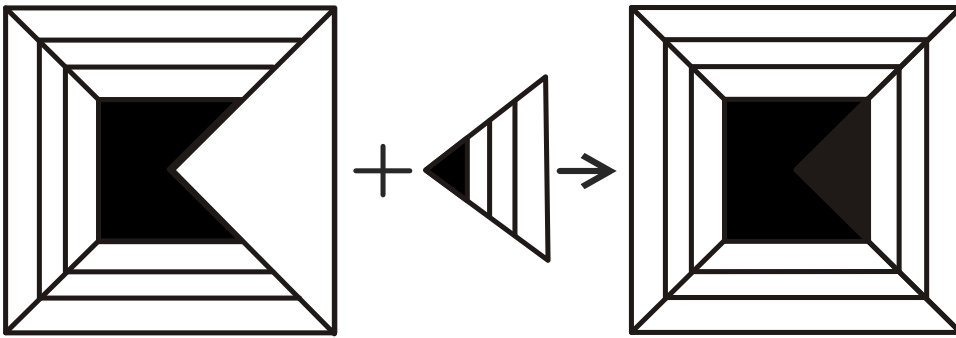

Hence, the **second option** is correct.

Q.
172

Directions: Select the figure from the options that can replace the question mark (?) and complete the pattern.

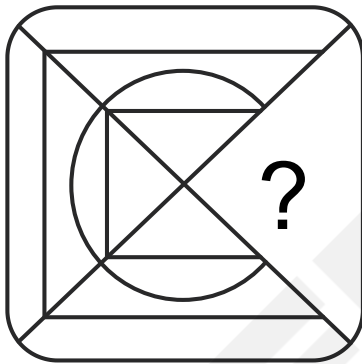

Option 1:

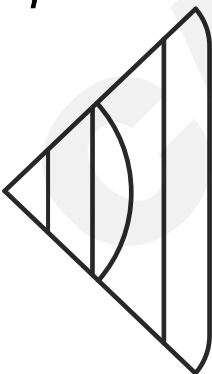

Option 2:

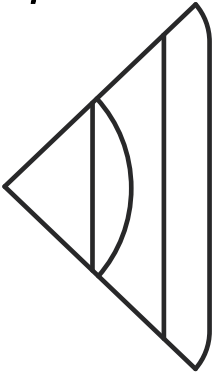

Option 3:

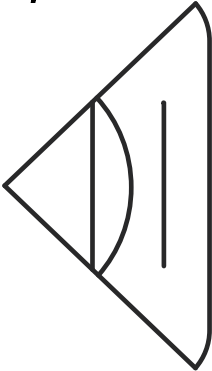

Option 4:

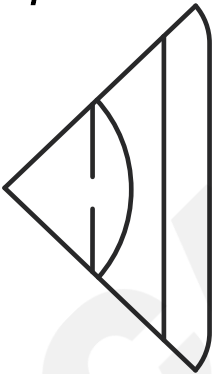

Correct Answer:

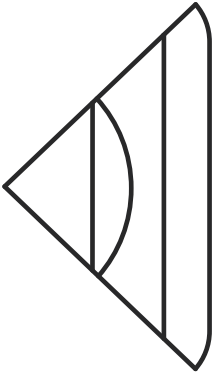

Solution:

On comparing the question figure and all the answer figures, the following figure will combine and make the complete pattern -

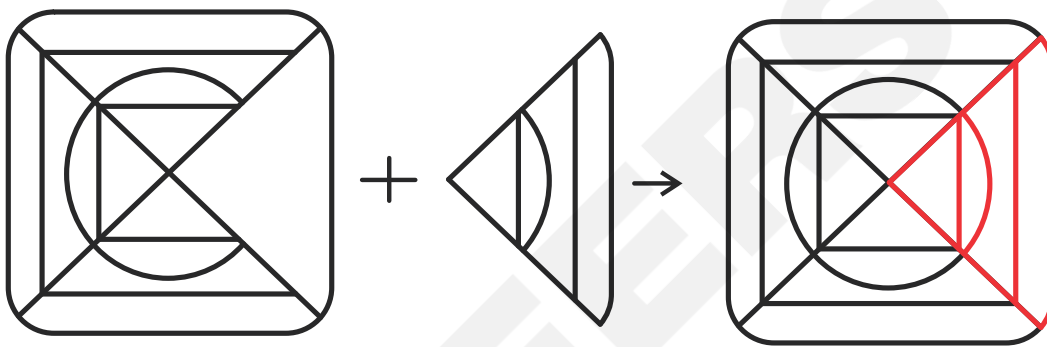

Hence, the **second option** is correct.

Q.
173

Directions: Select the option that will replace the question mark (?) in the figure given below to complete the pattern.

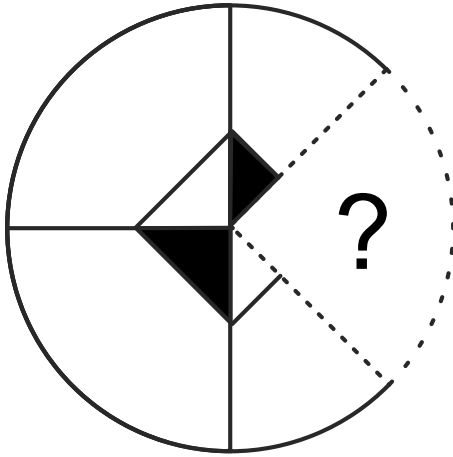

Option 1:

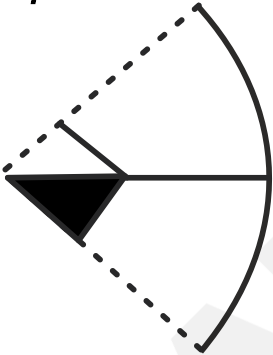

Option 2:

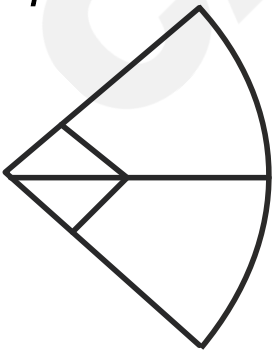

Option 3:

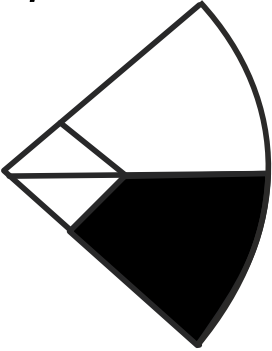

Option 4:

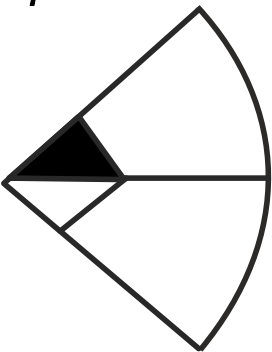

Correct Answer:

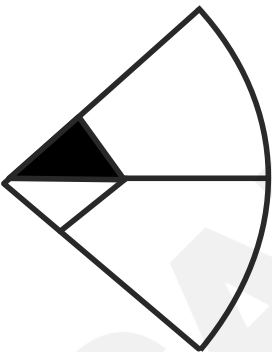

Solution:

On comparing the question figure and all the answer figures, the following figure will combine and make the complete pattern -

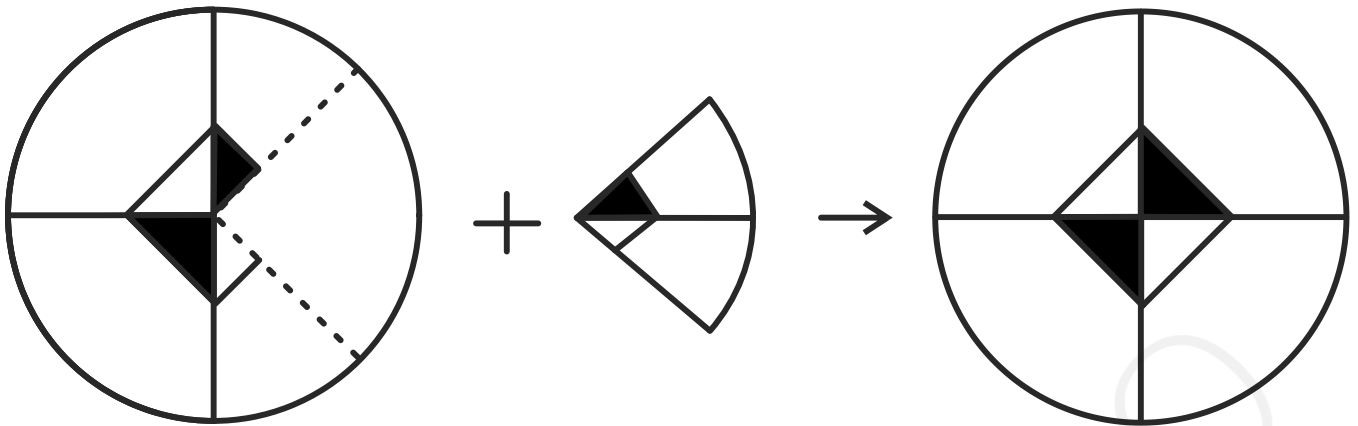

Hence, the **fourth option** is correct.

Q.
174

Directions: Select the figure from the given options that can replace the question mark (?) and complete the pattern (rotation is not allowed).

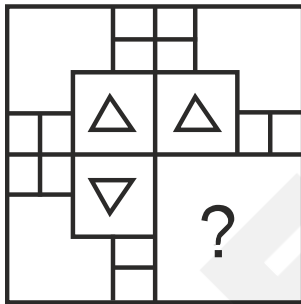

Option 1:

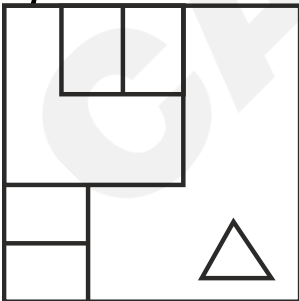

Option 2:

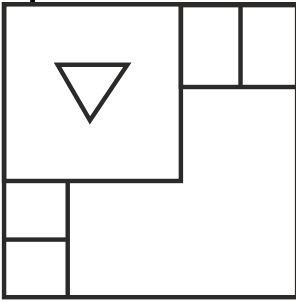

Option 3:

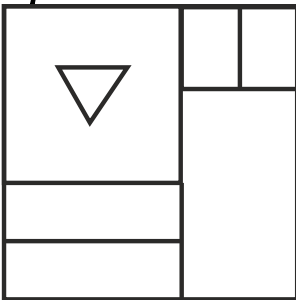

Option 4:

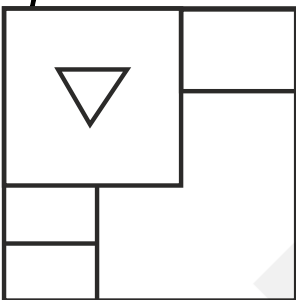

Correct Answer:

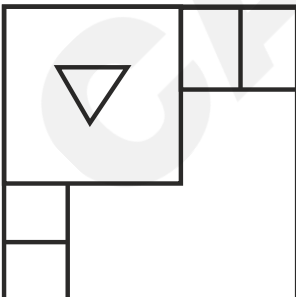

Solution:

On comparing the question figure and all the answer figures, the following figure will combine and make the complete pattern –

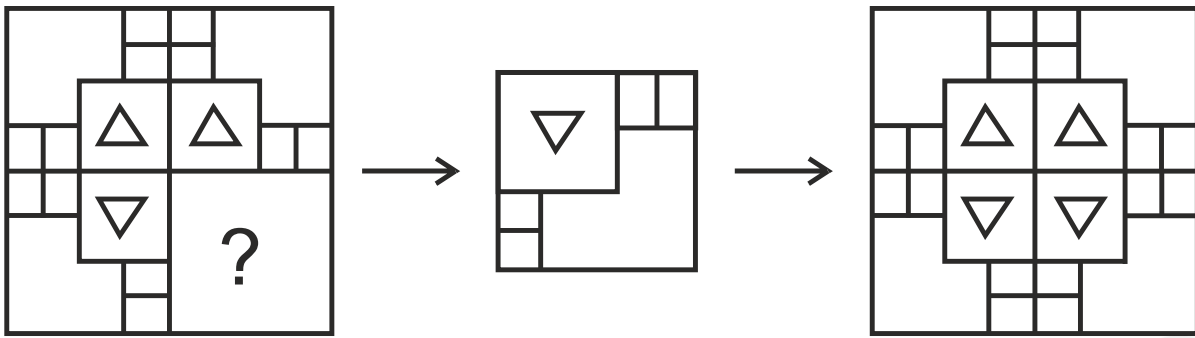

Hence, the **second option** is correct.

**Q.
175**

Directions: Select the figure from the options that can replace the question mark (?) and complete the pattern (rotation is NOT allowed).

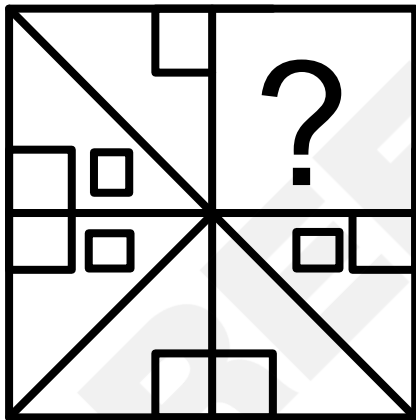

Option 1:

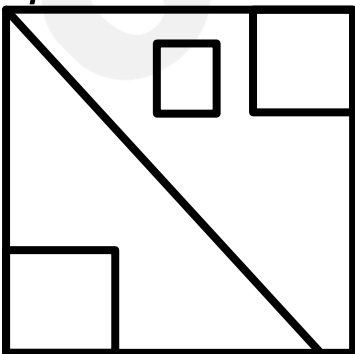

Option 2:

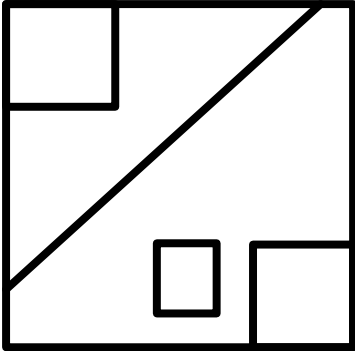

Option 3:

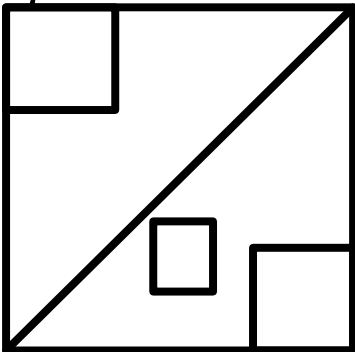

Option 4:

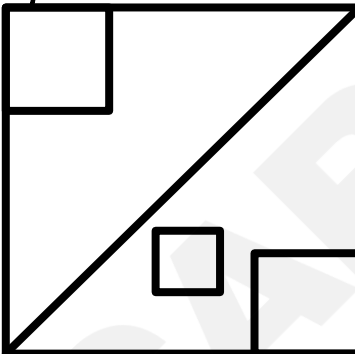

Correct Answer:

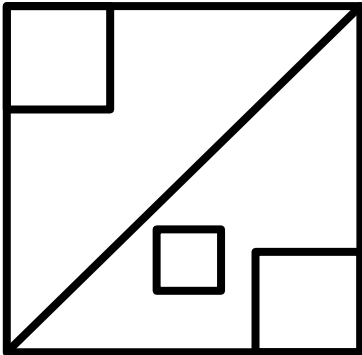

Solution:

On comparing the question figure and all the answer figures, the following figure will combine and make the complete pattern -

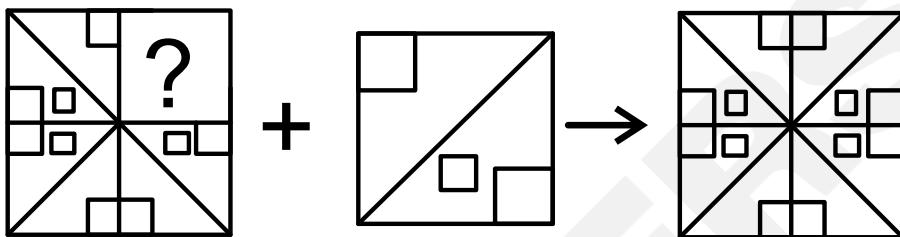

Hence, the **fourth option** is correct.

**Q.
176**

Directions: Select the figure from the options that can replace the question mark (?) and complete the given pattern. (Rotation is not allowed)

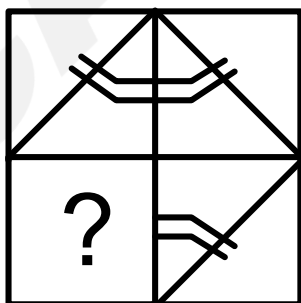

Option 1:

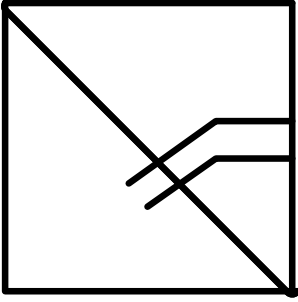

Option 2:

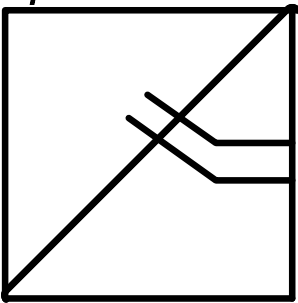

Option 3:

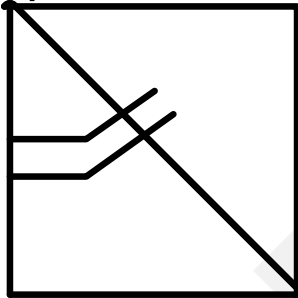

Option 4:

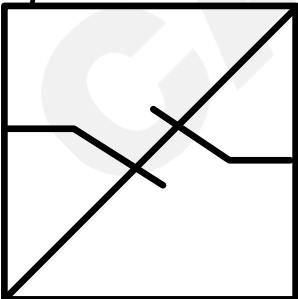

Correct Answer:

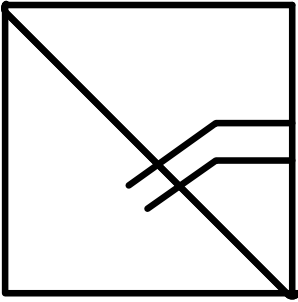

Solution:

On comparing the question figure and all the answer figures, the following figure will combine and make the complete pattern -

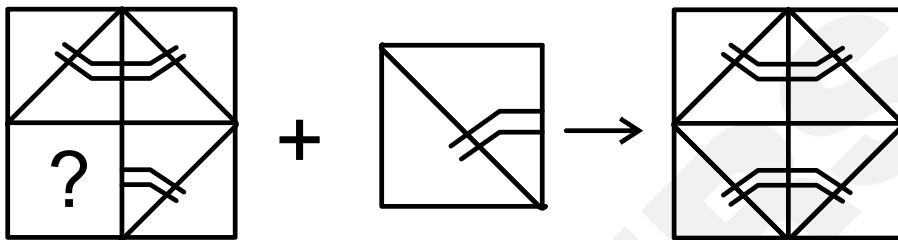

Hence, the **first option** is correct.

**Q.
177**

Directions: Select the option that can replace the question mark (?) in the given figure and complete the pattern.

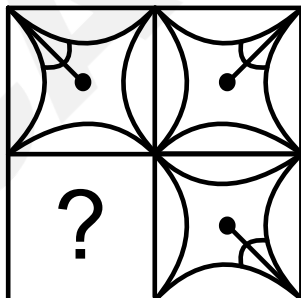

Option 1:

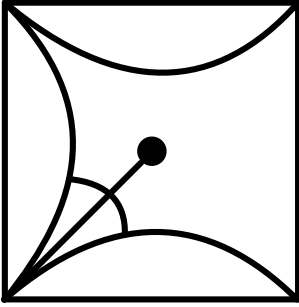

Option 2:

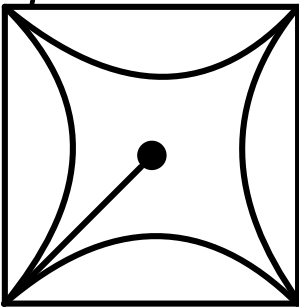

Option 3:

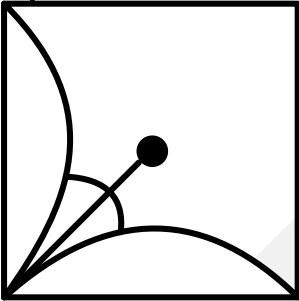

Option 4:

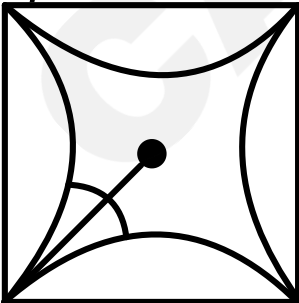

Correct Answer:

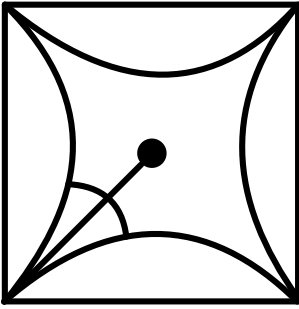

Solution:

On comparing the question figure and all the answer figures, the following figure will combine and make the complete pattern -

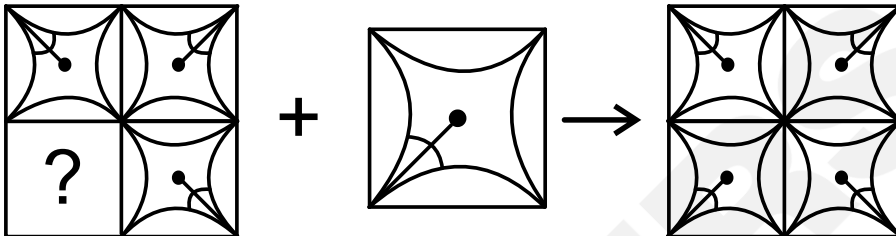

Hence, the **fourth option** is correct.

Q.
178

Directions: Select the figure from the options that can replace the question mark (?) and complete the pattern (rotation is NOT allowed).

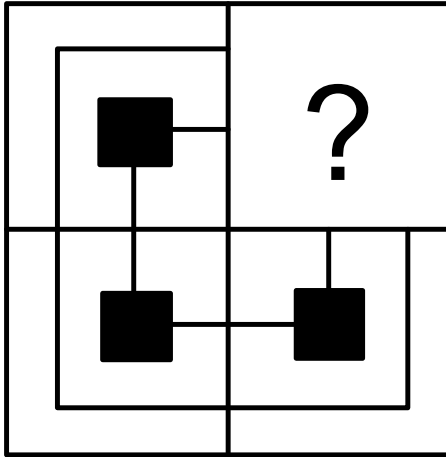

Option 1:

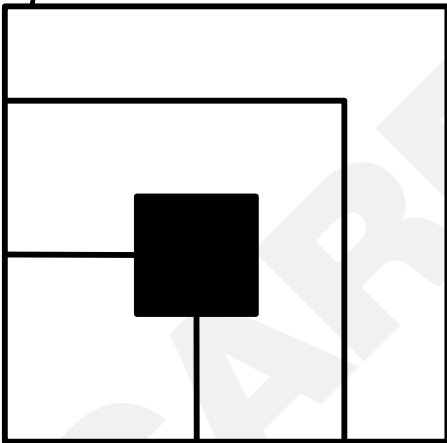

Option 2:

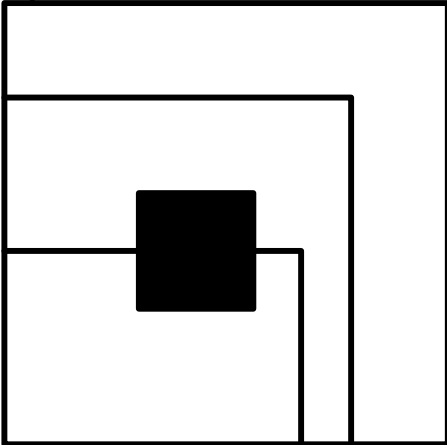

Option 3:

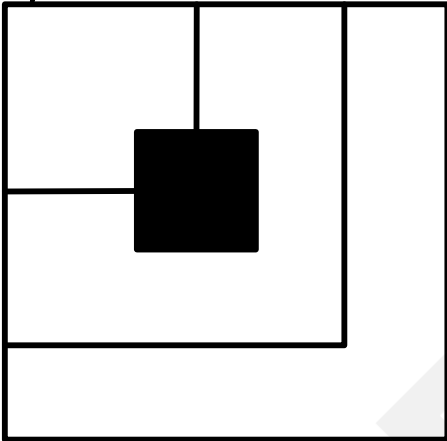

Option 4:

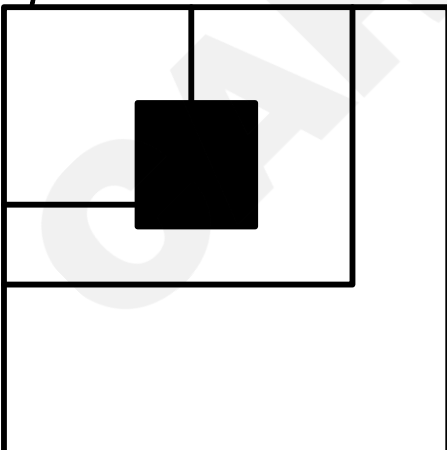

Correct Answer:

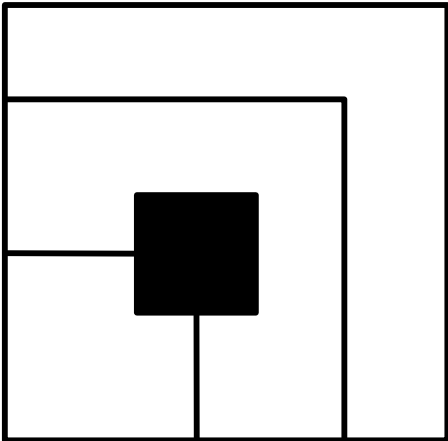

Solution:

On comparing the question figure and all the answer figures, the following figure will combine and make the complete pattern -

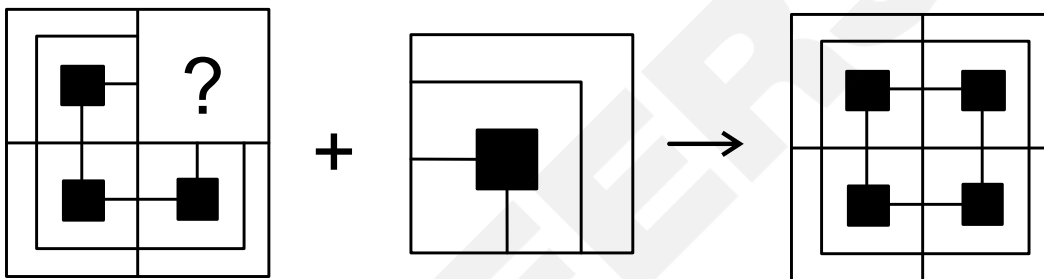

Hence, the **first option** is correct.

Q.
179

Directions: Select the figure from the given options that can replace the question mark (?) and complete the pattern.

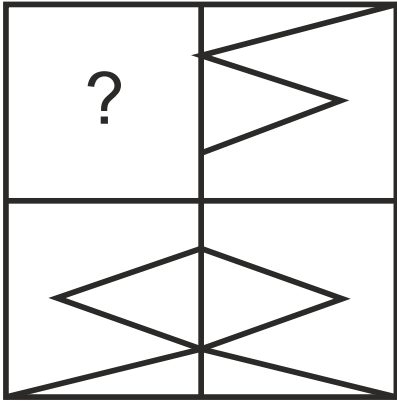

Option 1:

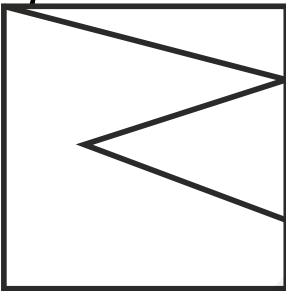

Option 2:

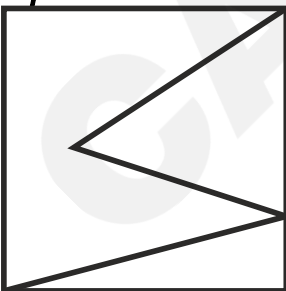

Option 3:

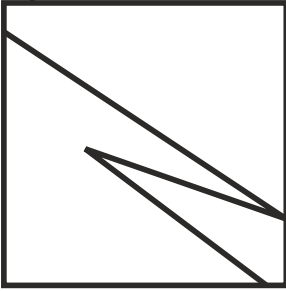

Option 4:

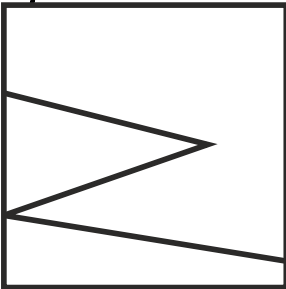

Correct Answer:

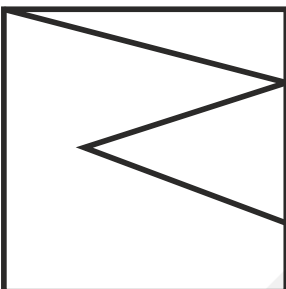

Solution:

On comparing the question figure and all the answer figures, the following figure will combine and make the complete pattern -

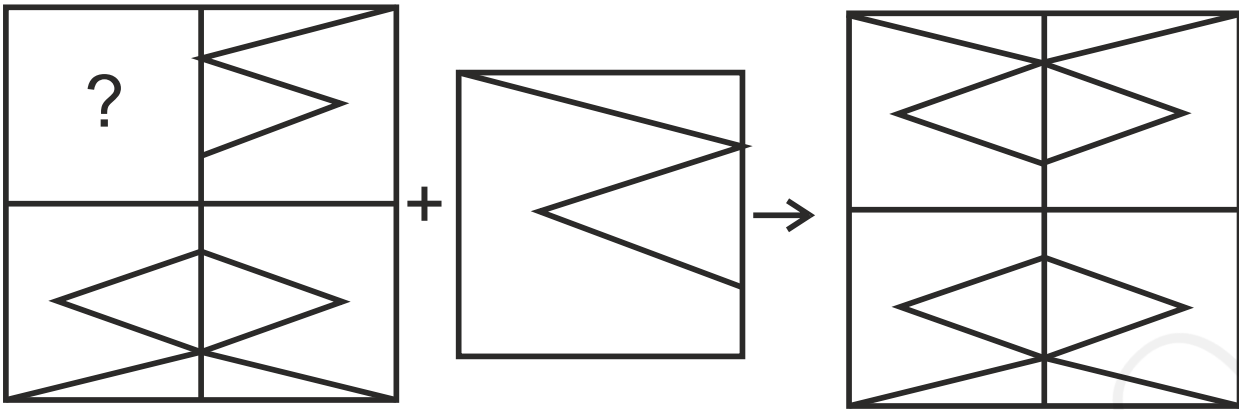

Hence, the **first option** is correct.

**Q.
180**

Directions: Select the figure from the options that can replace the question mark (?) and complete the given pattern.

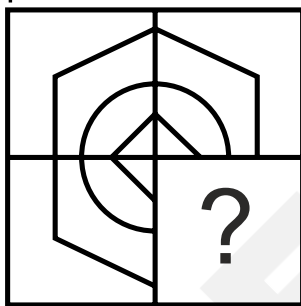

Option 1:

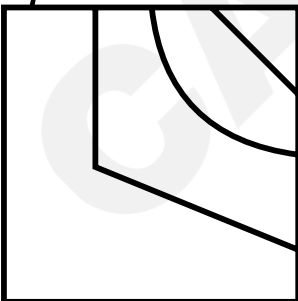

Option 2:

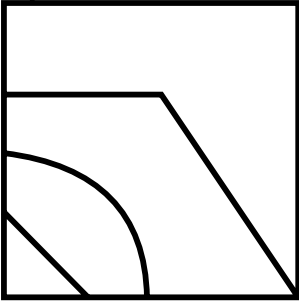

Option 3:

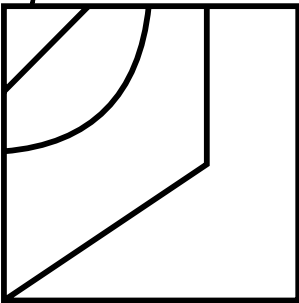

Option 4:

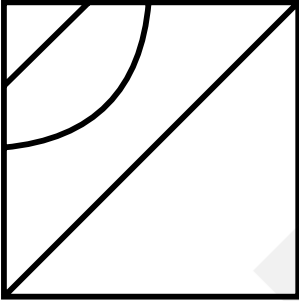

Correct Answer:

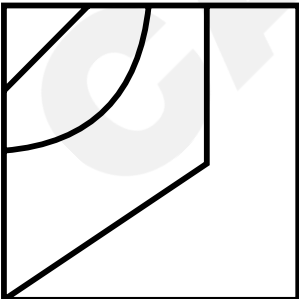

Solution:

On comparing the question figure and all the answer figures, the following figure will combine and make the complete pattern -

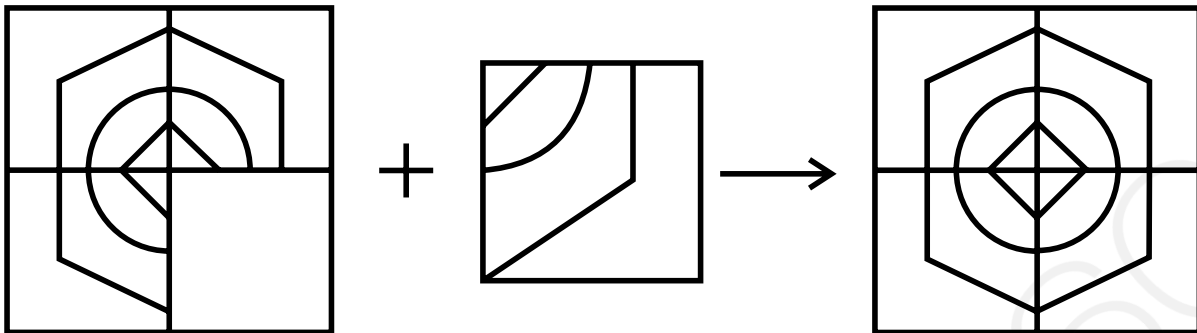

Hence, the **third option** is correct.

Q.
181

Directions: Select the figure from the options that can replace the question mark (?) and complete the pattern.
(Rotation is not allowed)

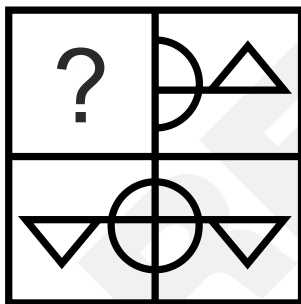

Option 1:

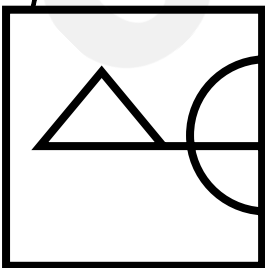

Option 2:

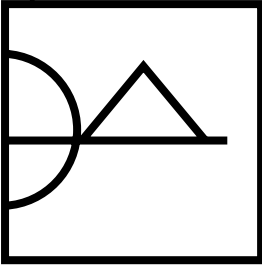

Option 3:

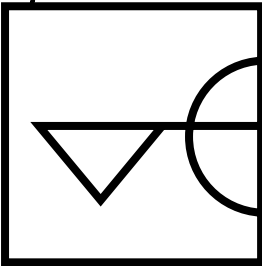

Option 4:

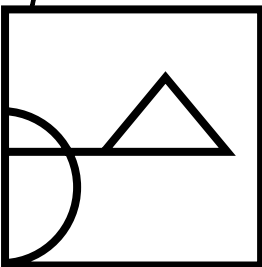

Correct Answer:

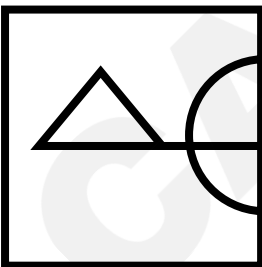

Solution:

On comparing the question figure and all the answer figures, the following figure will combine and make the complete pattern –

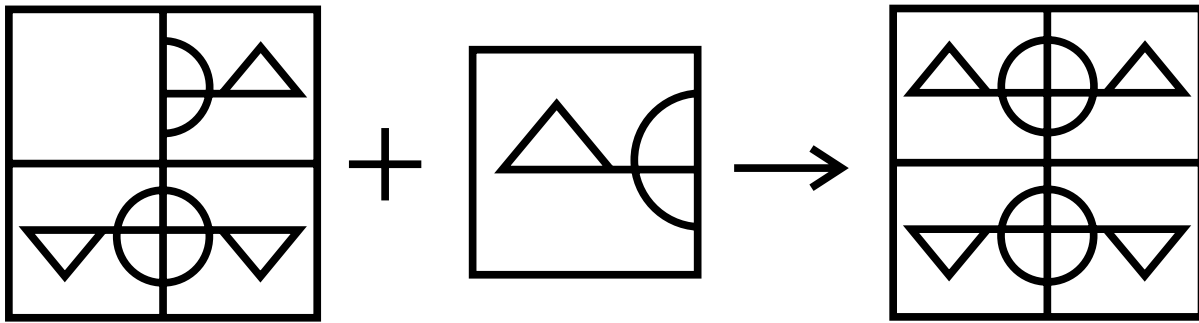

Hence, the **first option** is correct.

**Q.
182**

Directions: Select the figure from the options that can replace the question mark (?) and complete the given pattern.

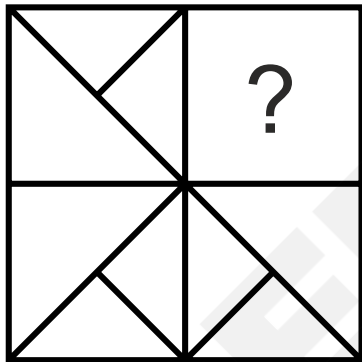

Option 1:

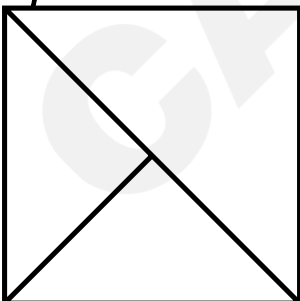

Option 2:

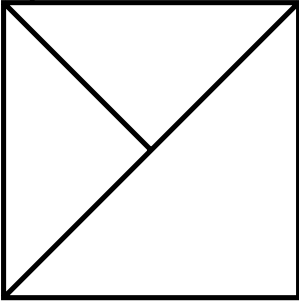

Option 3:

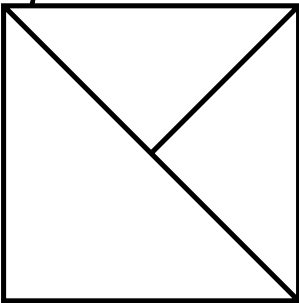

Option 4:

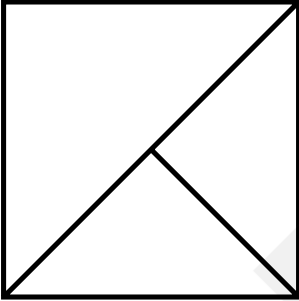

Correct Answer:

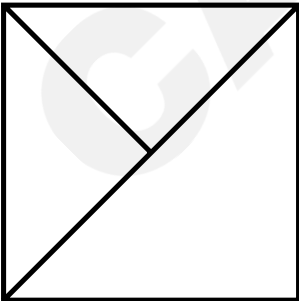

Solution:

On comparing the question figure and all the answer figures, the following figure will combine and make the complete pattern -

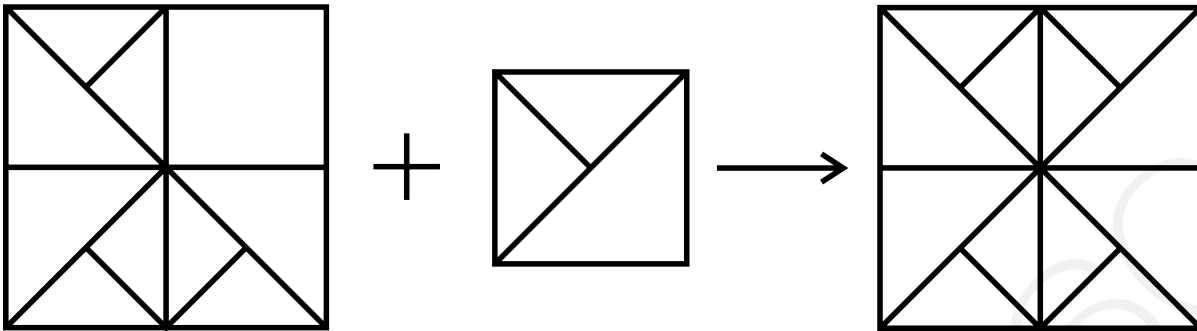

Hence, the **second option** is correct.

Q.
183

Directions: Select the figure from the options that can replace the question mark (?) and complete the pattern.

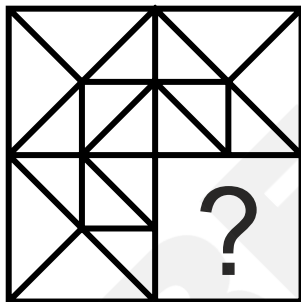

Option 1:

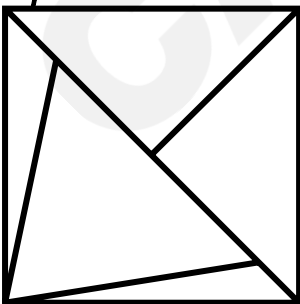

Option 2:

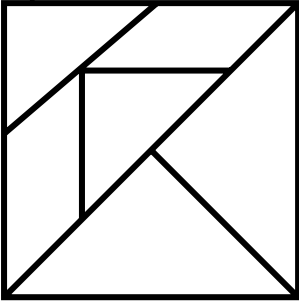

Option 3:

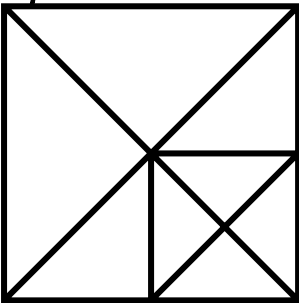

Option 4:

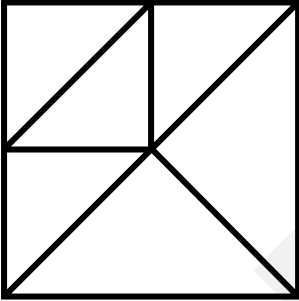

Correct Answer:

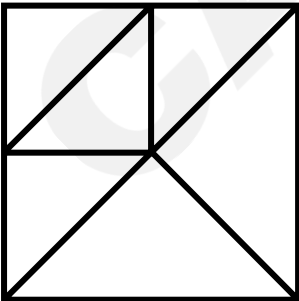

Solution:

On comparing the question figure and all the answer figures, the following figure will combine and make the complete pattern -

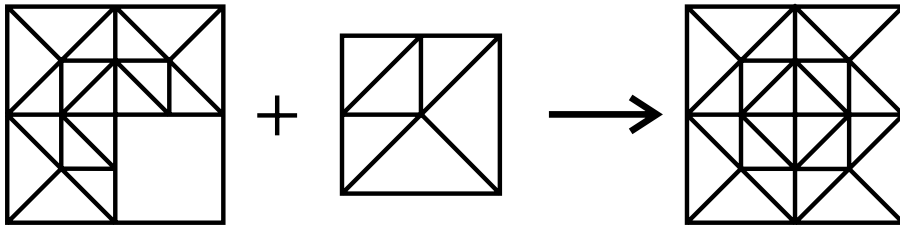

Hence, the **fourth option** is correct.

**Q.
184**

Directions: Select the figure from the options that can replace the question mark (?) and complete the pattern (rotation is not allowed).

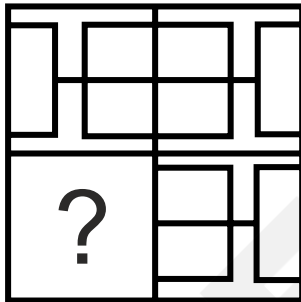

Option 1:

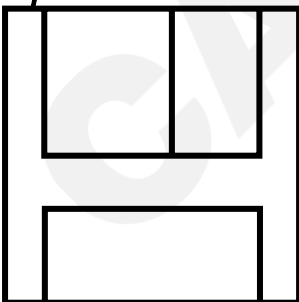

Option 2:

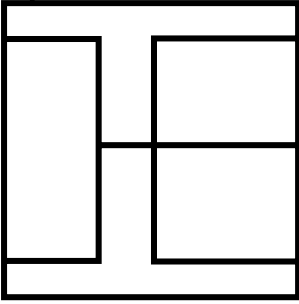

Option 3:

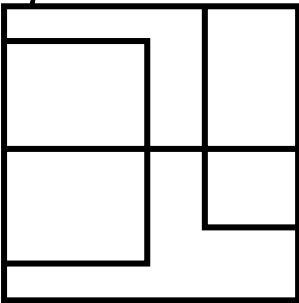

Option 4:

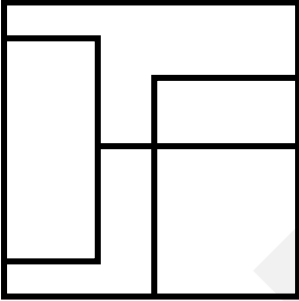

Correct Answer:

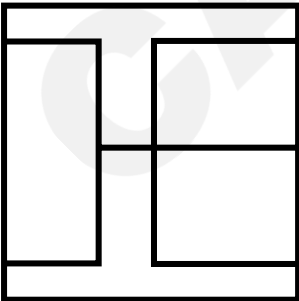

Solution:

On comparing the question figure and all the answer figures, the following figure will combine and make the complete pattern -

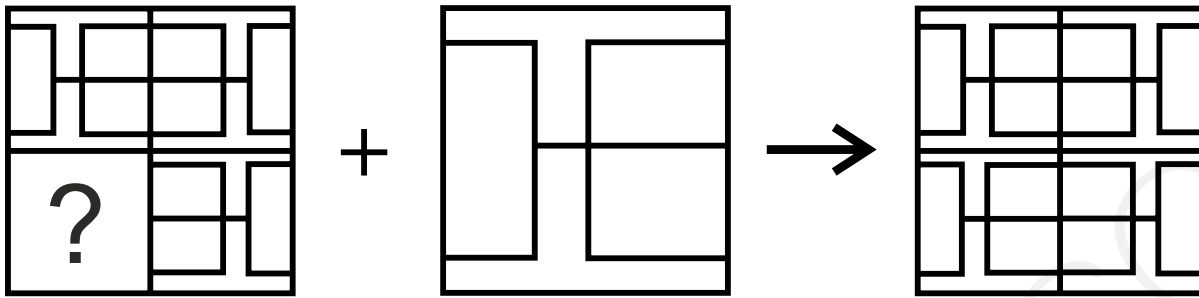

Hence, the **second option** is correct.

Q. 185

Directions: Select the figure from the options that can replace the question mark (?) and complete the pattern (rotation not allowed).

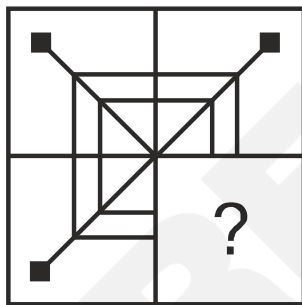

Option 1:

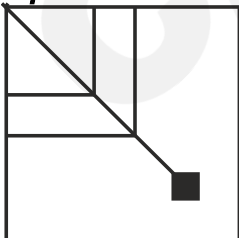

Option 2:

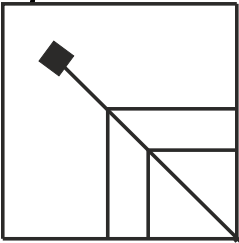

Option 3:

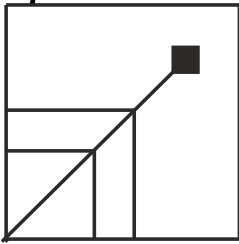

Option 4:

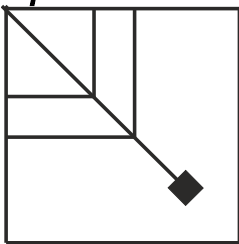

Correct Answer:

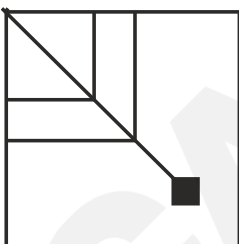

Solution:

On comparing the question figure and all the answer figures, the following figure will combine and make the complete pattern –

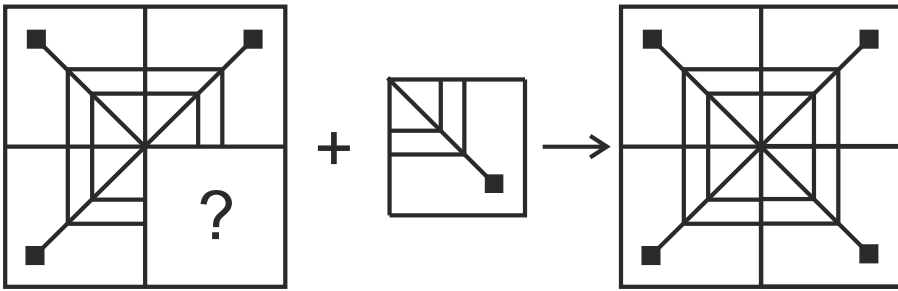

Hence, the **first option** is correct.

Q.
186

Directions: Select the figure from the options that can replace the question mark (?) and complete the given pattern.

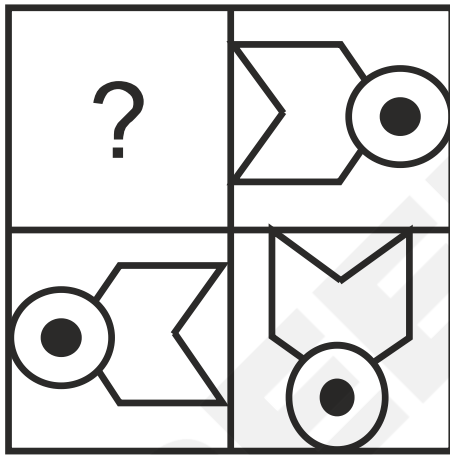

Option 1:

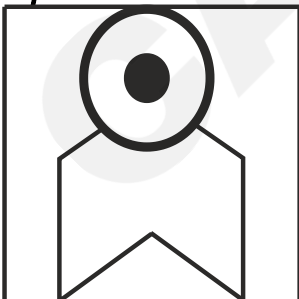

Option 2:

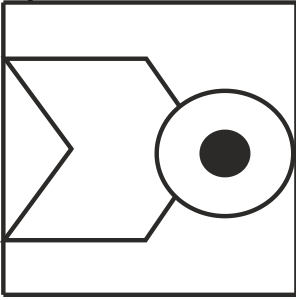

Option 3:

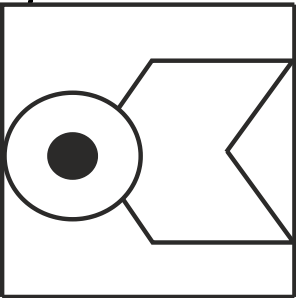

Option 4:

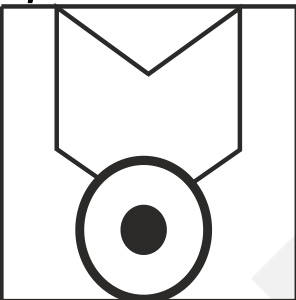

Correct Answer:

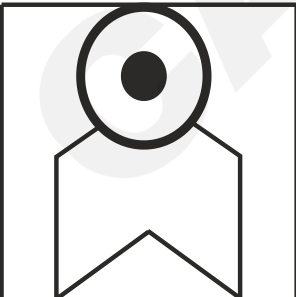

Solution:

In the given figure, rotate the head of the figure in the clockwise direction to complete the figure. On comparing the question figure and all the answer figures, the following figure will combine and make the complete pattern.

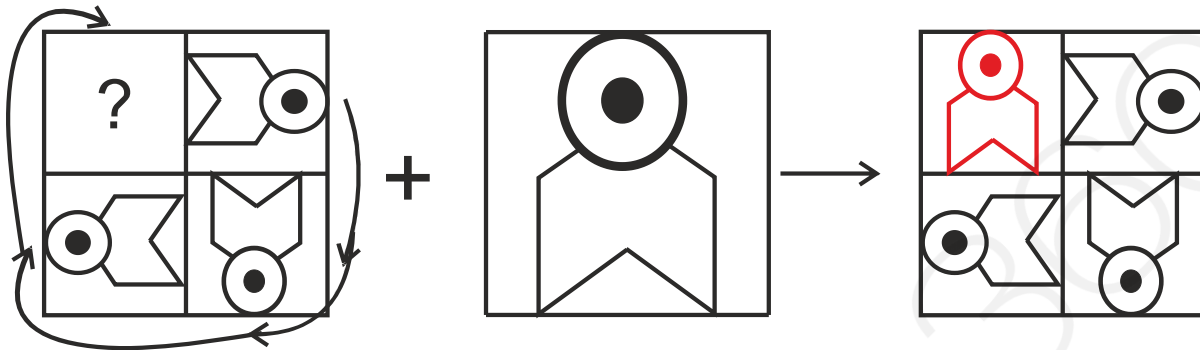

Hence, the **first option** is correct.

**Q.
187**

Directions: Select the figure from the options that can replace the question mark (?) and complete the pattern.
(Rotation is not allowed)

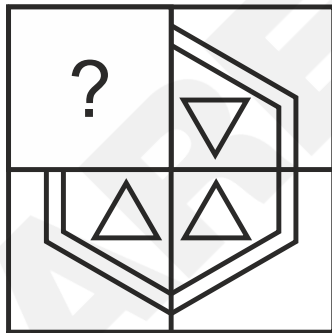

Option 1:

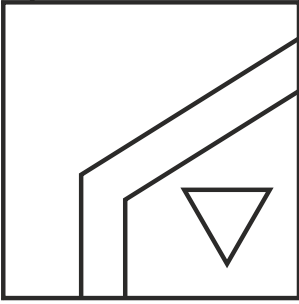

Option 2:

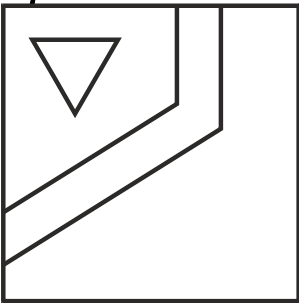

Option 3:

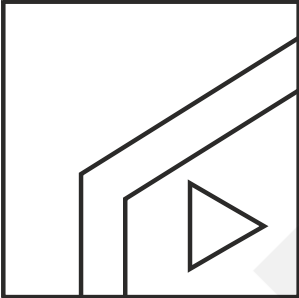

Option 4:

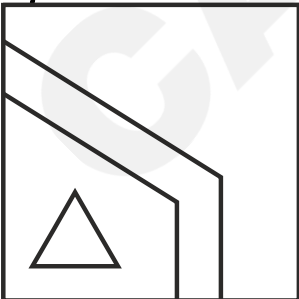

Correct Answer:

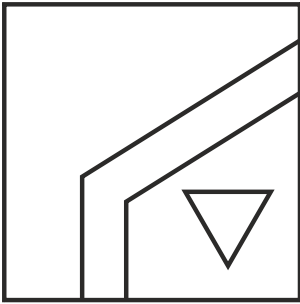

Solution:

On comparing the question figure and all the answer figures, the following figure will combine and make the complete pattern -

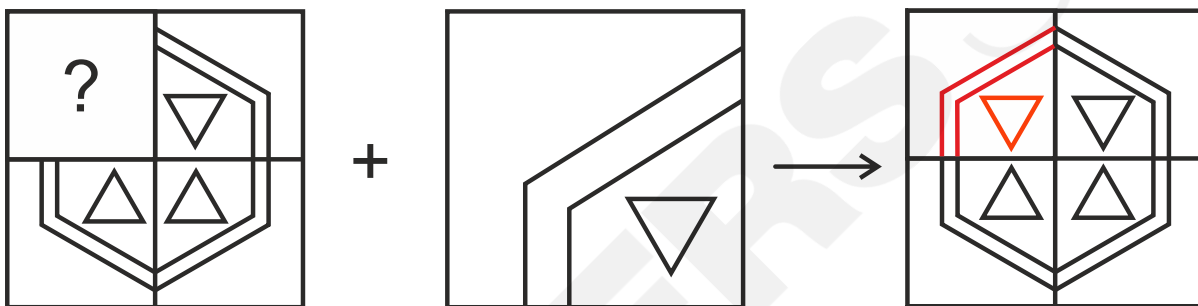

Hence, the **first option** is correct.

**Q.
188**

Directions: Select the figure from the options that can replace the question mark (?) and complete the pattern (Rotation is not allowed).

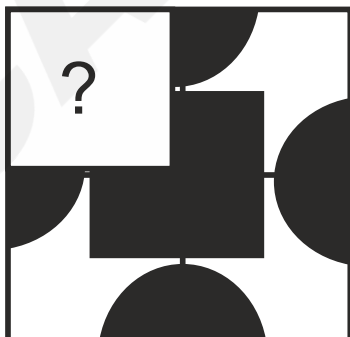

Option 1:



Option 2:



Option 3:

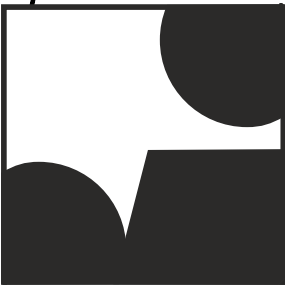

Option 4:



Correct Answer:



Solution:

On comparing the question figure and all the answer figures, the following figure will combine and make the complete pattern -

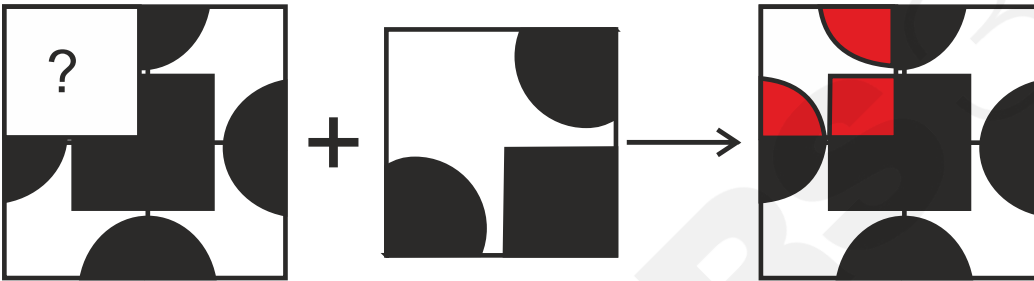

Hence, the **second option** is correct.

**Q.
189**

Directions: Select the figure from the options that can replace the question mark (?) and complete the given pattern.

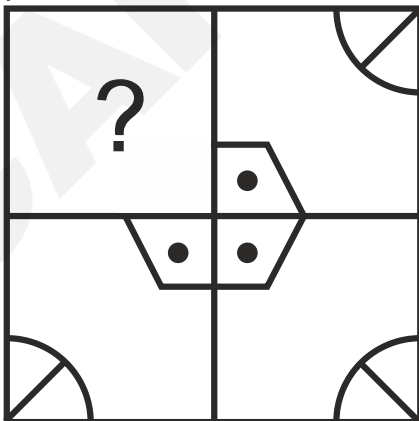

Option 1:

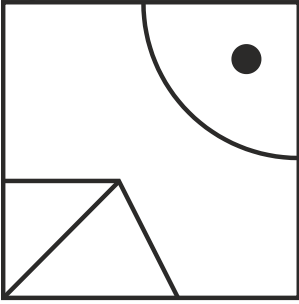

Option 2:

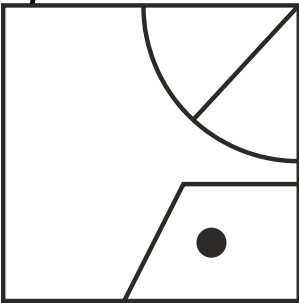

Option 3:

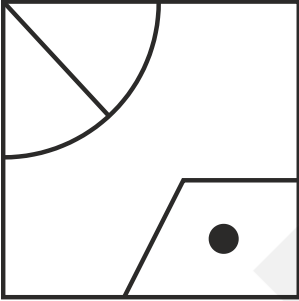

Option 4:

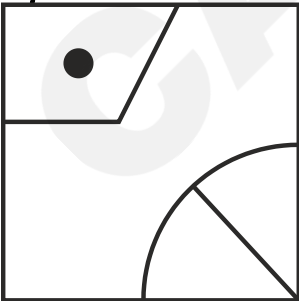

Correct Answer:

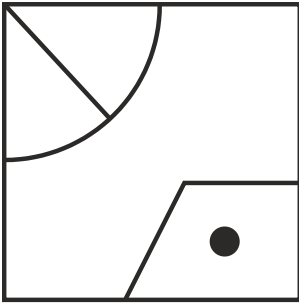

Solution:

On comparing the question figure and all the answer figures, the following figure will combine and make the complete pattern -

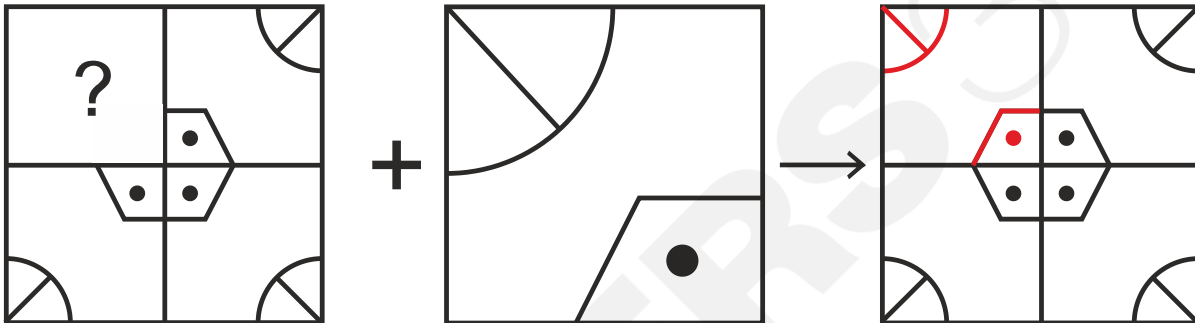

Hence, the **third option** is correct.

**Q.
190**

Directions: Select the figure from the options that can replace the question mark (?) and complete the pattern (rotation is NOT allowed).

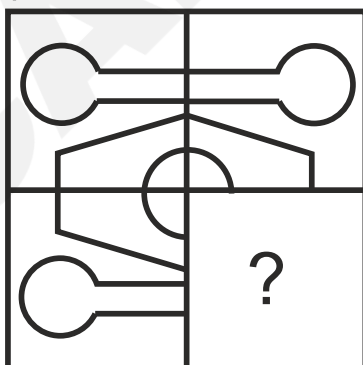

Option 1:

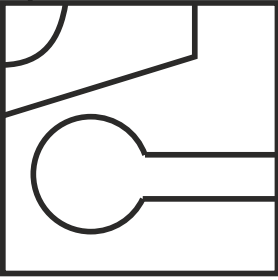

Option 2:

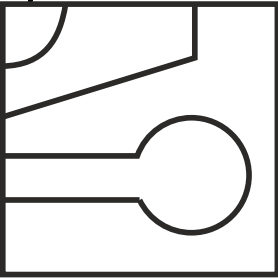

Option 3:

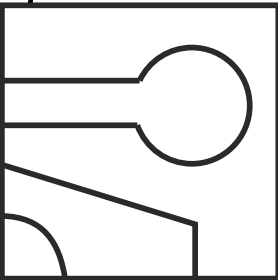

Option 4:

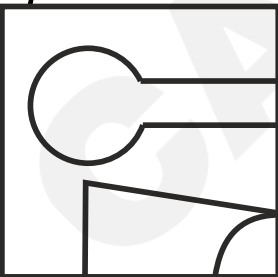

Correct Answer:

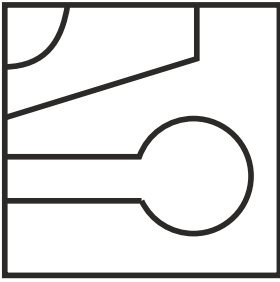

Solution:

On comparing the question figure and all the answer figures, the following figure will combine and make the complete pattern -



Hence, the **second option** is correct.

**Q.
191**

Directions: Select the figure from the options that can replace the question mark (?) and complete the pattern (rotation is NOT allowed).

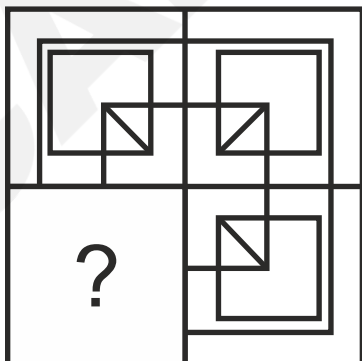

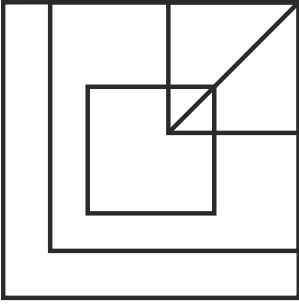
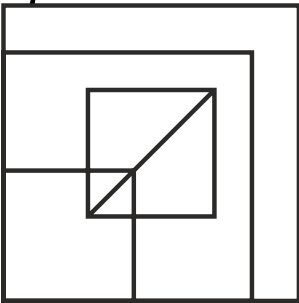
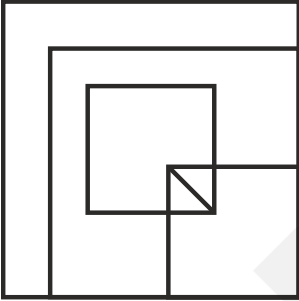
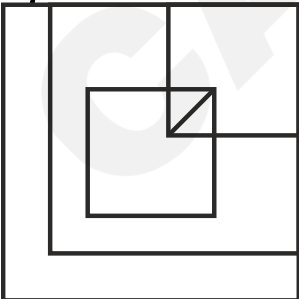
Option 1:*Option 2:**Option 3:**Option 4:*

Correct Answer:

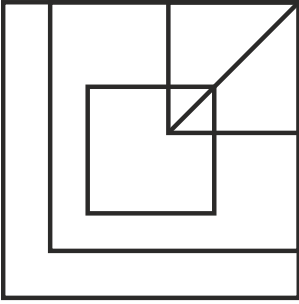

Solution:

On comparing the question figure and all the answer figures, the following figure will combine and make the complete pattern -

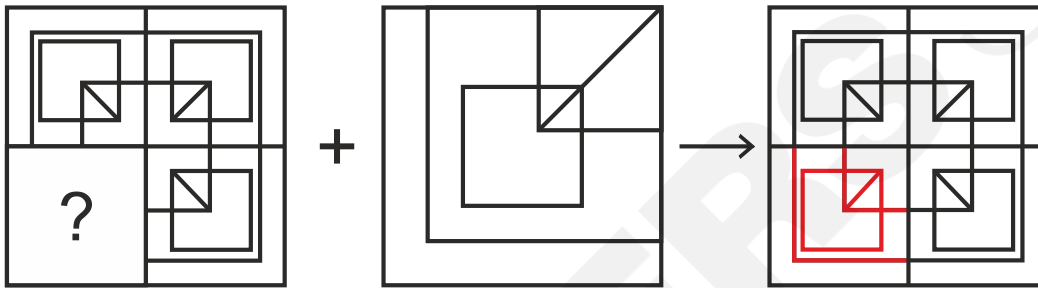

Hence, the **first option** is correct.

**Q.
192**

Directions: Select the figure from the options that can replace the question mark (?) and complete the pattern (rotation is not allowed).

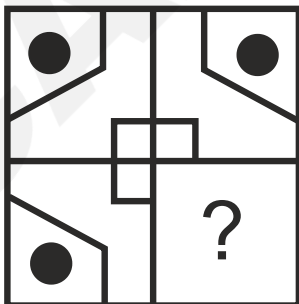

Option 1:

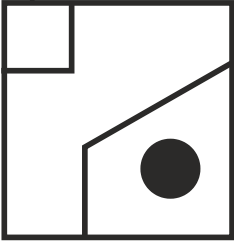

Option 2:

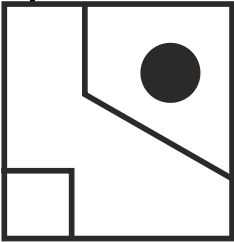

Option 3:

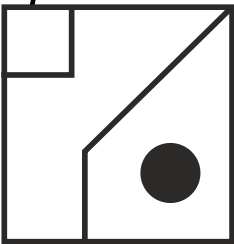

Option 4:

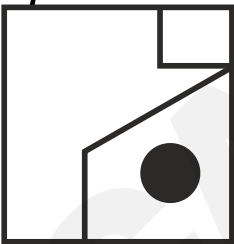

Correct Answer:

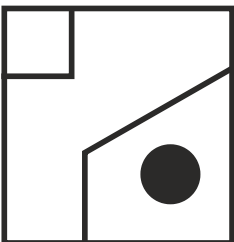

Solution:

On comparing the question figure and all the answer figures, the following figure will combine and make the complete pattern –

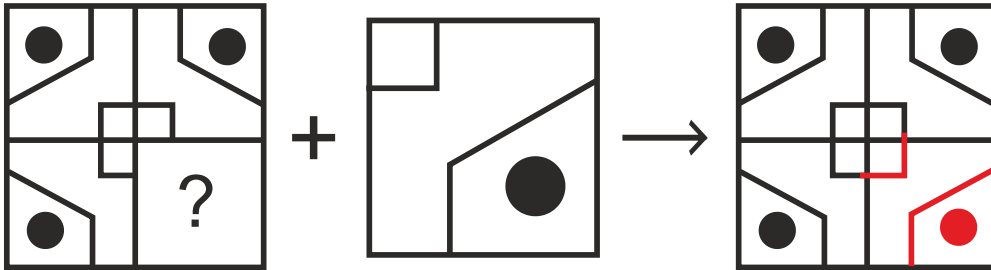

Hence, the **first option** is correct.

Q.
193

Directions: Select the figure from the options that can replace the question mark (?) and complete the pattern.

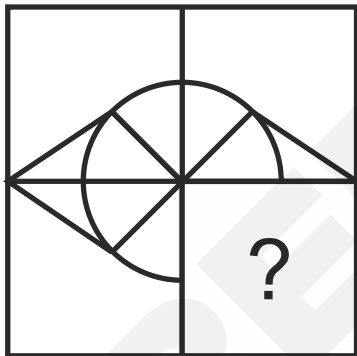

Option 1:

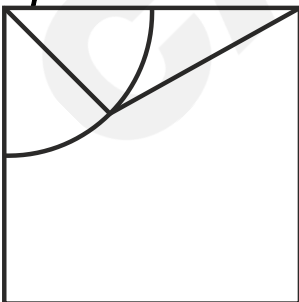

Option 2:

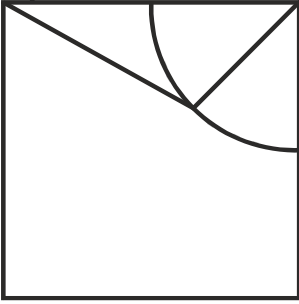

Option 3:

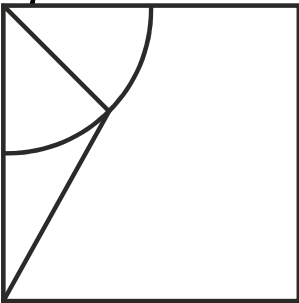

Option 4:

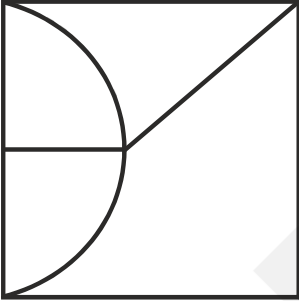

Correct Answer:

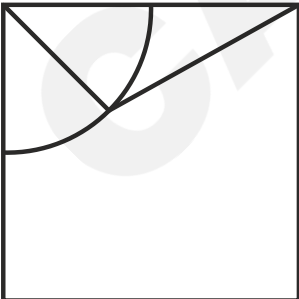

Solution:

On comparing the question figure and all the answer figures, the following figure will combine and make the complete pattern -

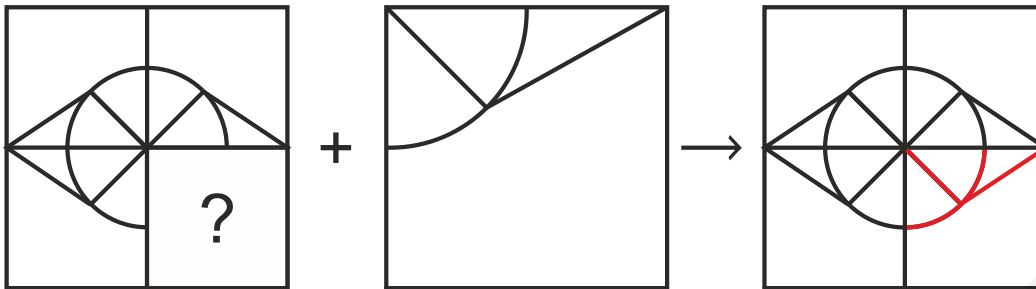

Hence, the **first option** is correct.

Q. 194

Directions: Select the figure from the options that can replace the question mark (?) and complete the pattern. (rotation is not allowed)

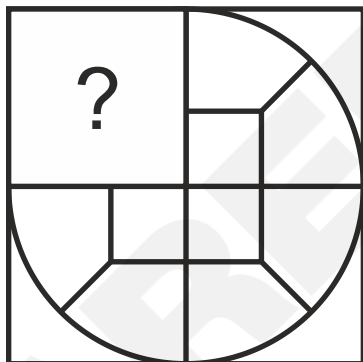

Option 1:

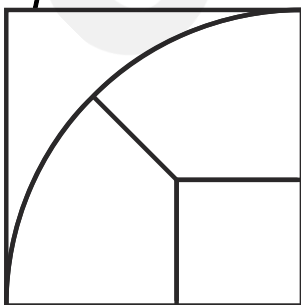

Option 2:

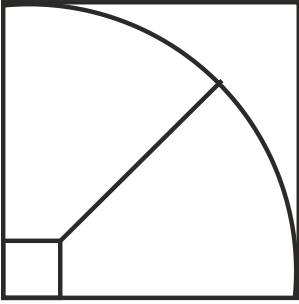

Option 3:

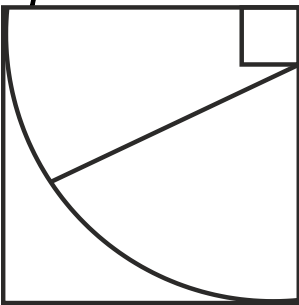

Option 4:

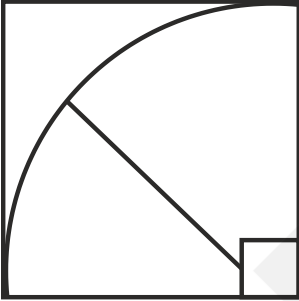

Correct Answer:

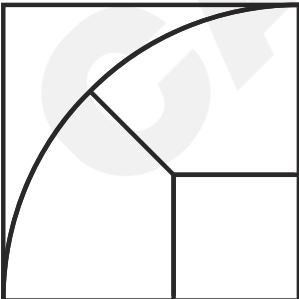

Solution:

On comparing the question figure and all the answer figures, the following figure will combine and make the complete pattern -

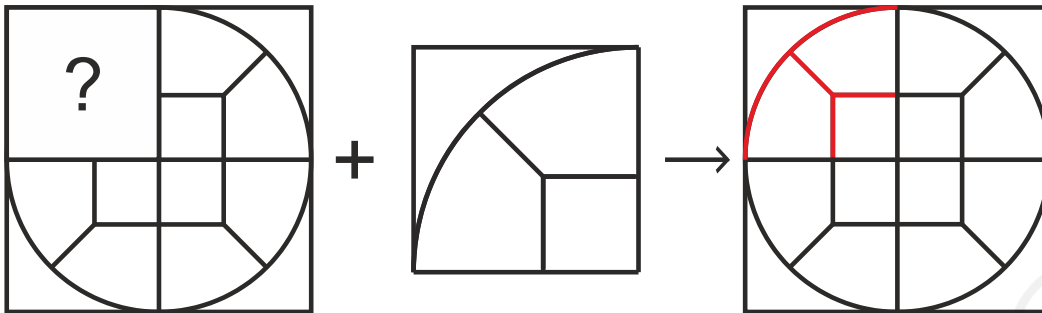

Hence, the **first option** is correct.

**Q.
195**

Directions: Select the option that can replace the question mark (?) in the given figure and complete the pattern (rotation is not allowed).

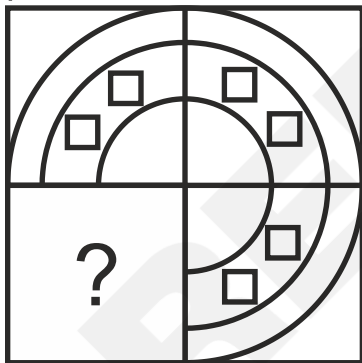

Option 1:

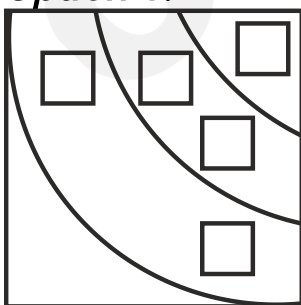

Option 2:

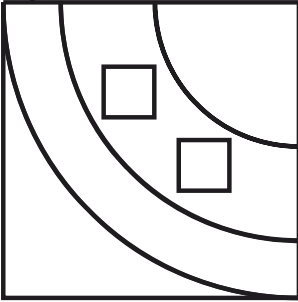

Option 3:

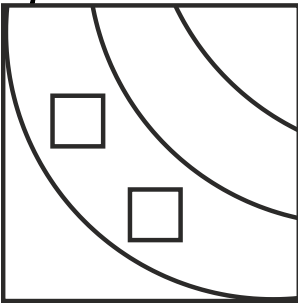

Option 4:

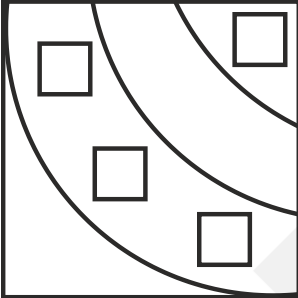

Correct Answer:

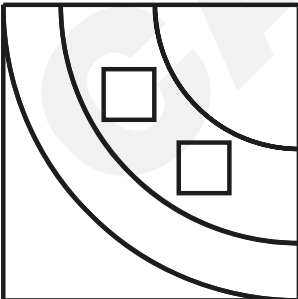

Solution:

On comparing the question figure and all the answer figures, the following figure will combine and make the complete pattern -

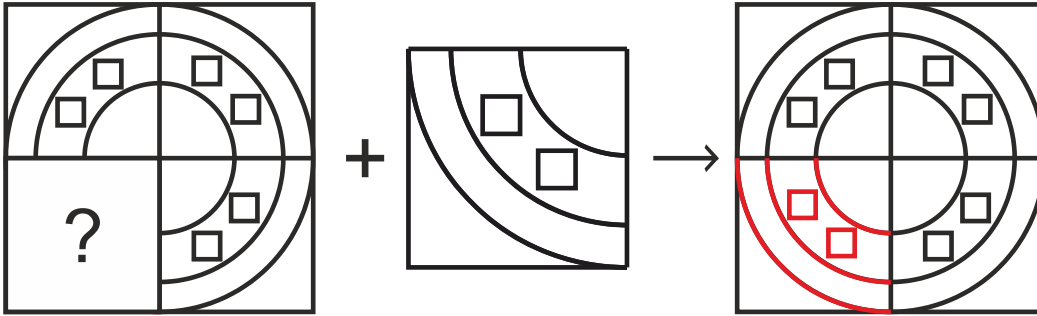

Hence, the **second option** is correct.

Q.
196

Directions: Select the figure from the options that can replace the question mark (?) and complete the given pattern.

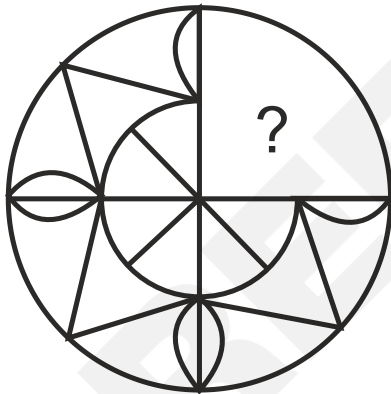

Option 1:



Option 2:

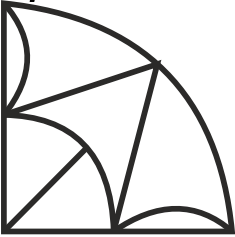

Option 3:

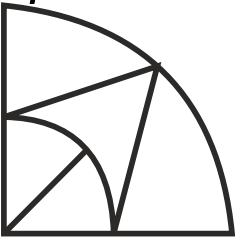

Option 4:

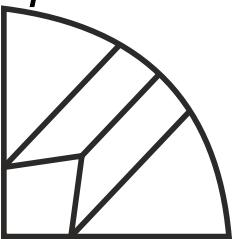

Correct Answer:



Solution:

On comparing the question figure and all the answer figures, the following figure will combine and make the complete pattern -

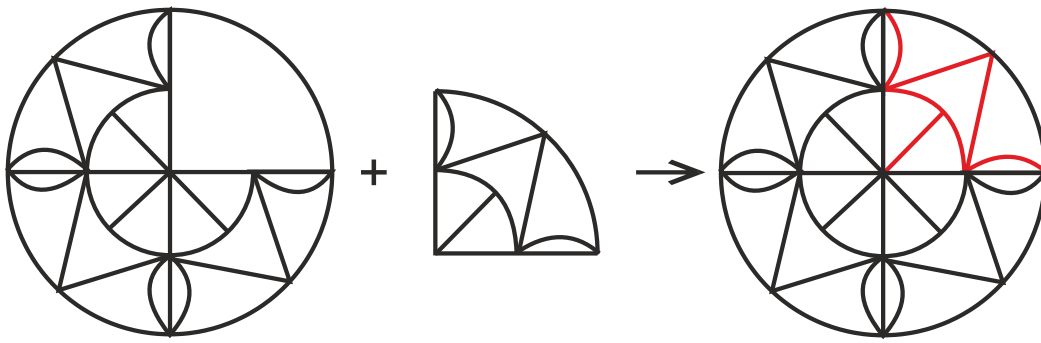

Hence, the **second option** is correct.

Q.
197

Directions: Select the figure from the options that can replace the question mark (?) and complete the pattern.

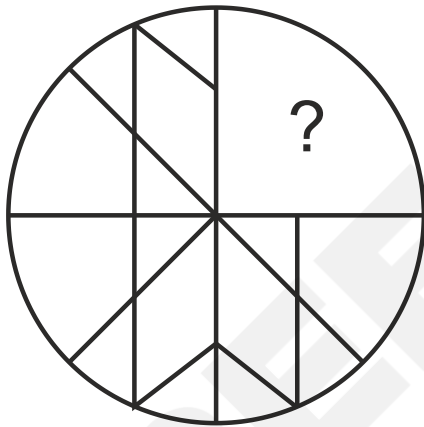

Option 1:

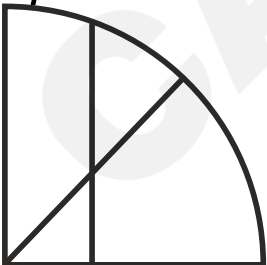

Option 2:

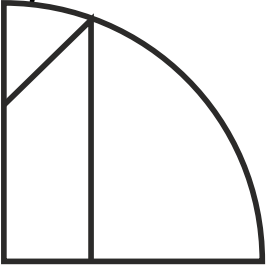

Option 3:

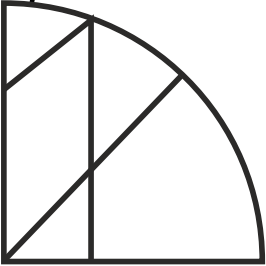

Option 4:

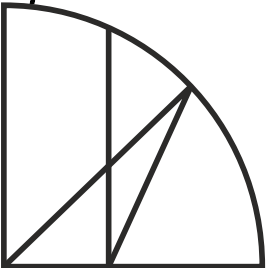

Correct Answer:

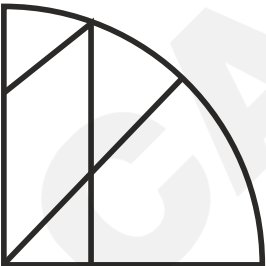

Solution:

On comparing the question figure and all the answer figures, the following figure will combine and make the complete pattern –

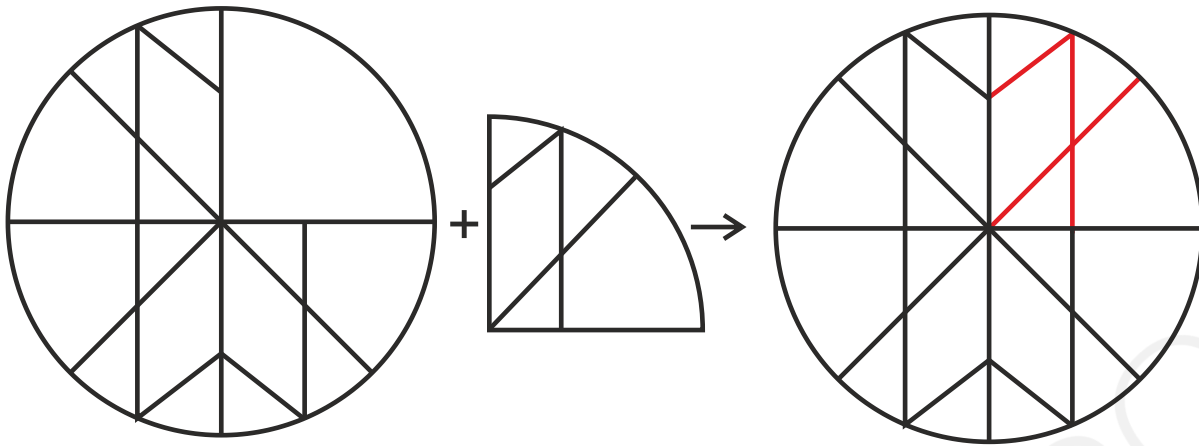

Hence, the **third option** is correct.

Q.
198

Directions: Select the figure from the options that can replace the question mark (?) and complete the pattern.

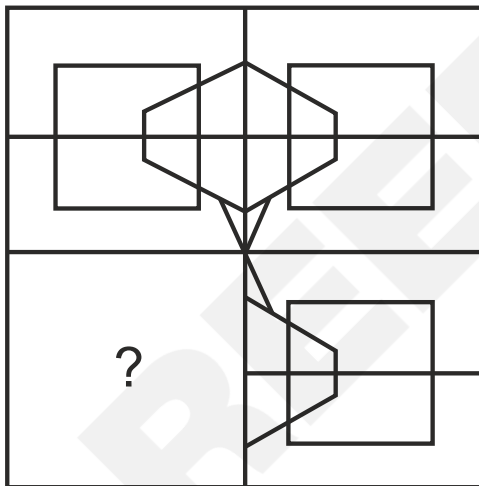

Option 1:

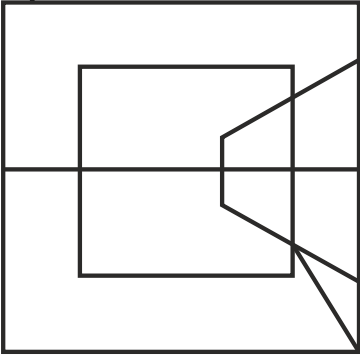

Option 2:

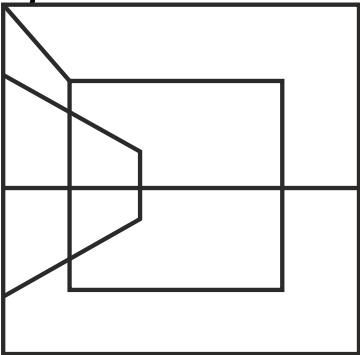

Option 3:

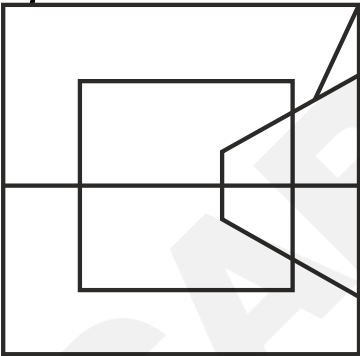

Option 4:

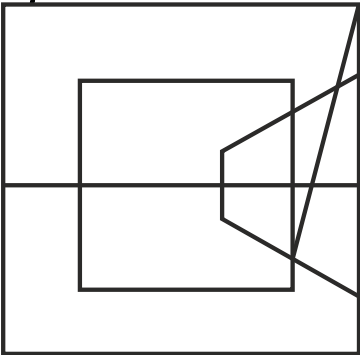

Correct Answer:

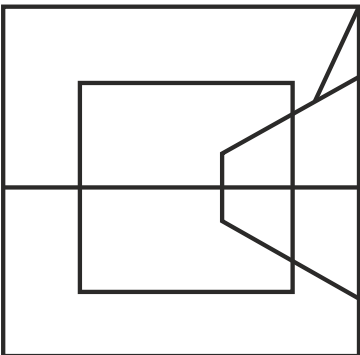

Solution:

On comparing the question figure and all the answer figures, the following figure will combine and make the complete pattern -

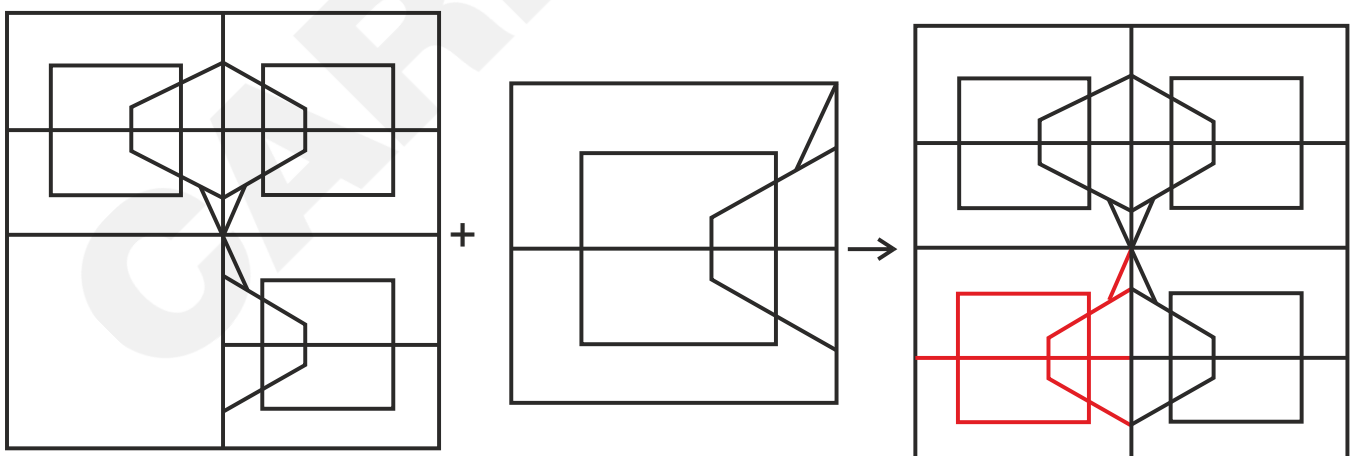

Hence, the **third option** is correct.