

# **CAREERS** 360

## **PREPARATION** **Series**

# **Embedded Figure**

---

**All Questions with Solutions**

---

- Q. 1** **Directions:** Select one of the option figures that is embedded in the given figure (rotation is NOT allowed).

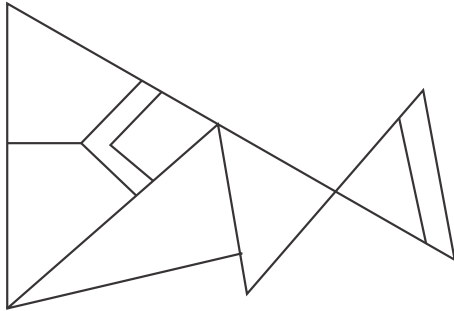

**Option 1:**

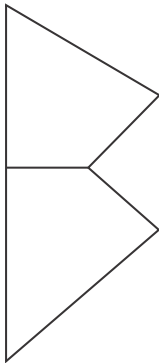

**Option 2:**

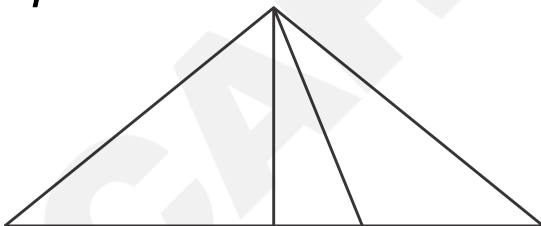

**Option 3:**

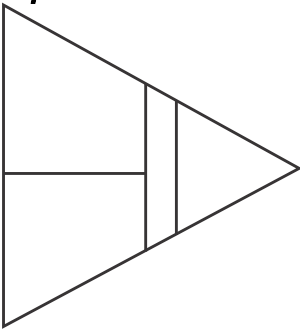

**Option 4:**

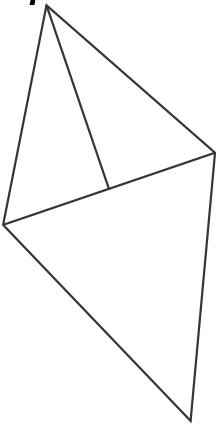

**Correct Answer:**

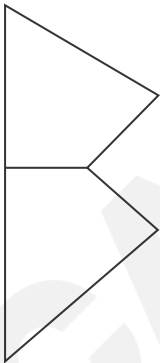

**Solution:**

The embedded figure will have the same orientation as the given figure. Only the first option figure is embedded in the given figure.

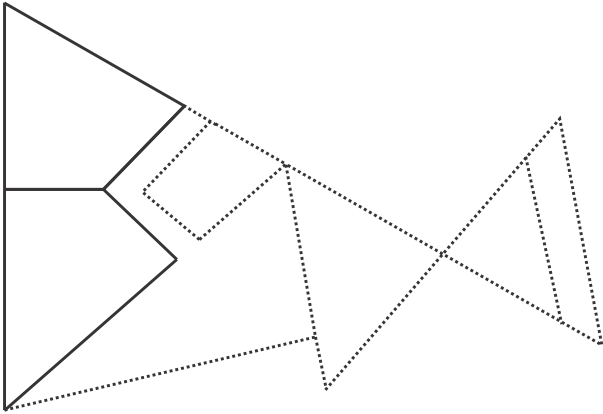

Hence, the **first option** is correct.

- Q. 2** **Directions:** Select one of the option figures that is embedded in the given figure (rotation is NOT allowed).

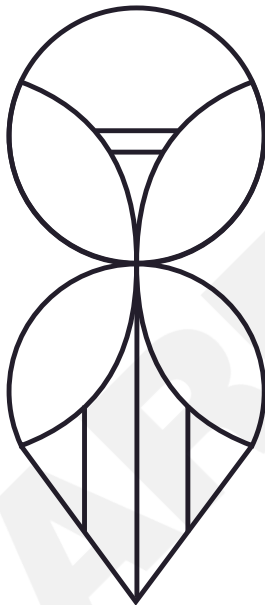

*Option 1:*



*Option 2:*



*Option 3:*



*Option 4:*

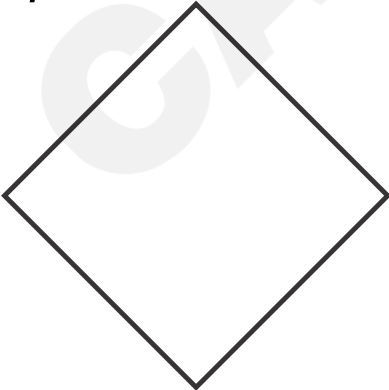

**Correct Answer:**



**Solution:**

The embedded figure will have the same orientation as the main figure. Only the second option figure is embedded in the given figure.

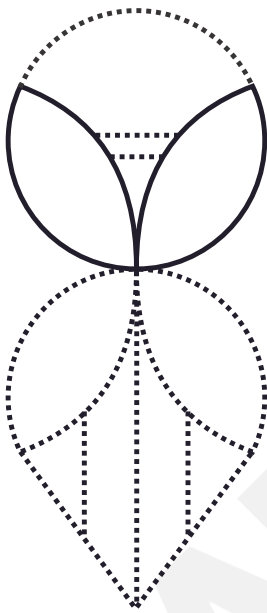

Hence, the **second option** is correct.

- Q. 3** **Directions:** Select one of the option figures that is embedded in the given figure (rotation is NOT allowed).

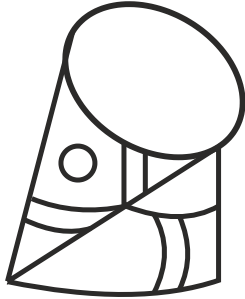

**Option 1:**

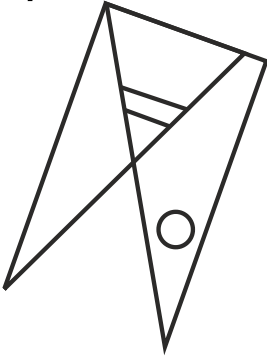

**Option 2:**

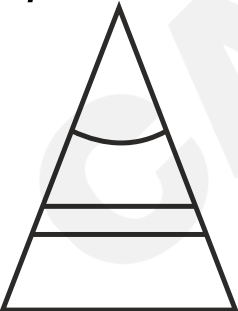

Option 3:

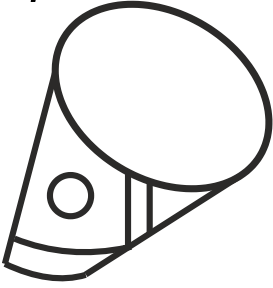

Option 4:

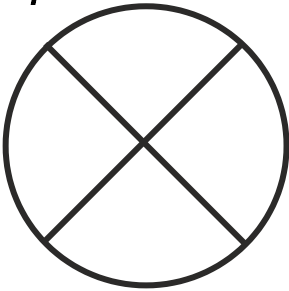

Correct Answer:

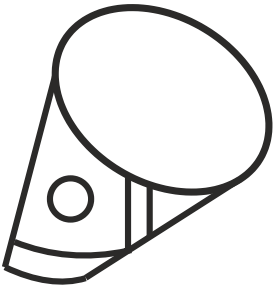

**Solution:**

The embedded figure will have the same orientation as the main figure. Only the third option figure is embedded in the given figure.

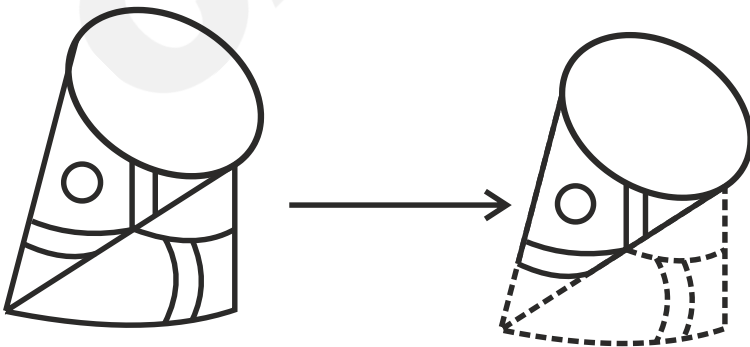

Hence, the **third option** is correct.

- Q. 4** **Directions:** Select the option figure that is embedded in the given figure (rotation is NOT allowed).

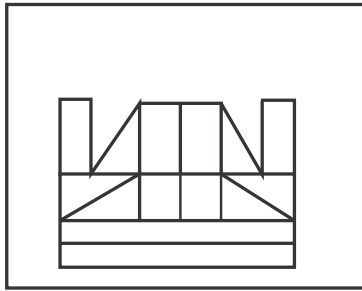

**Option 1:**

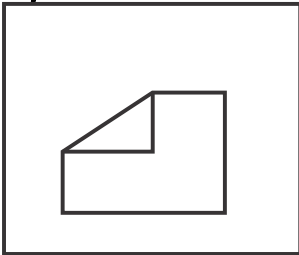

**Option 2:**

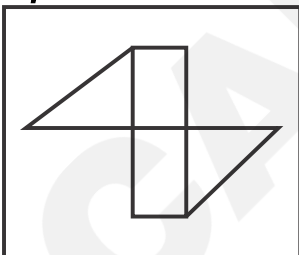

**Option 3:**

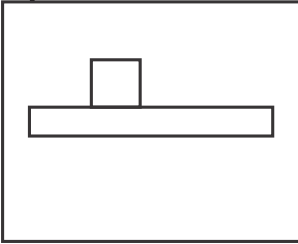

**Option 4:**

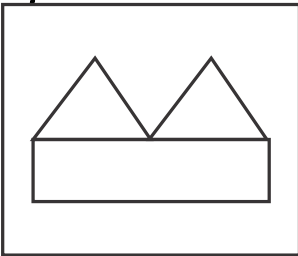

**Correct Answer:**

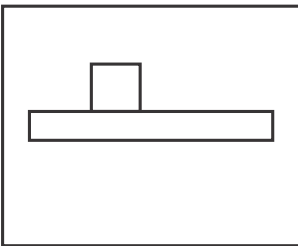

**Solution:**

The embedded figure will have the same orientation as the main figure. By comparison of all the option figures, only the third option figure is embedded in the given question figure.

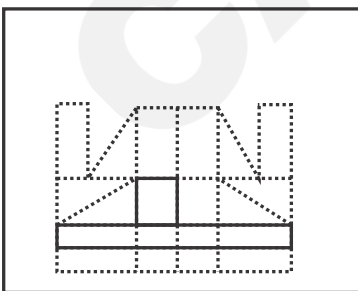

Hence, the **third option** is correct.

- Q. 5** **Directions:** Select the option figure that is embedded in the given figure (rotation is not allowed).

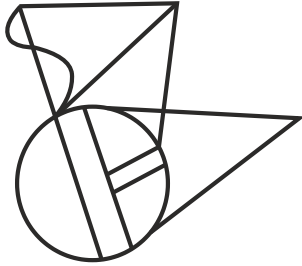

**Option 1:**

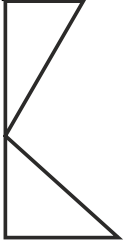

**Option 2:**

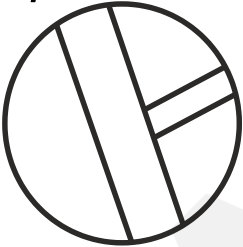

**Option 3:**

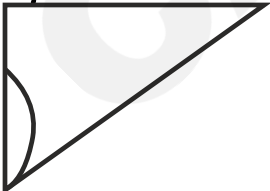

**Option 4:**

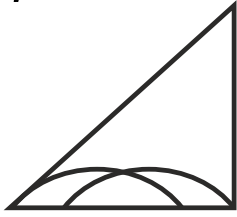

**Correct Answer:**

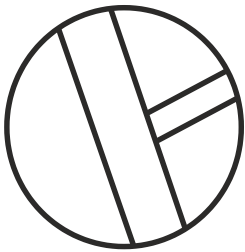

**Solution:**

As rotation is not allowed, we will check which option figure fits in the question figure.

The figure in the second option is embedded in the question figure as shown below –

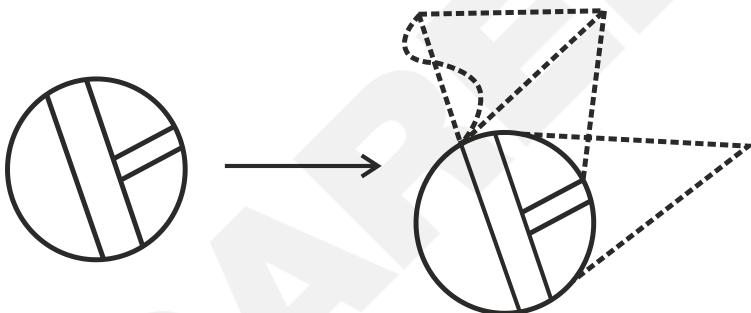

The figure in the second option resembles the question figure. Hence, the **second option** is correct.

- Q. 6** **Directions:** Select the option figure that is embedded in the given figure (rotation is NOT allowed).

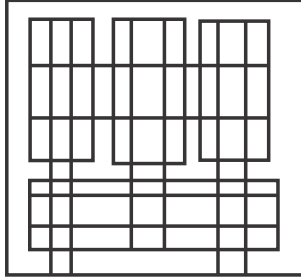

**Option 1:**

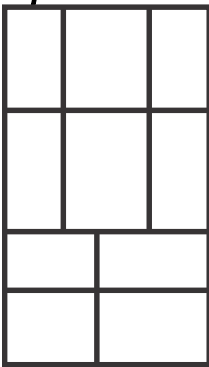

**Option 2:**



**Option 3:**

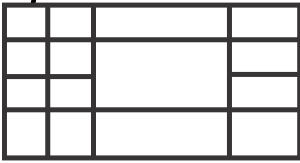

**Option 4:**

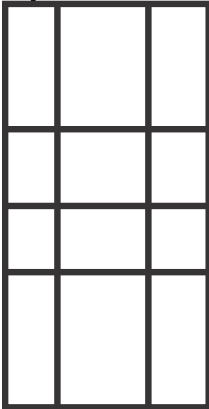

**Correct Answer:**

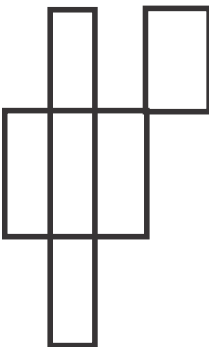

**Solution:**

Since the rotation of the figure is not allowed, let's check which option figure can exactly fit itself in the given question figure.

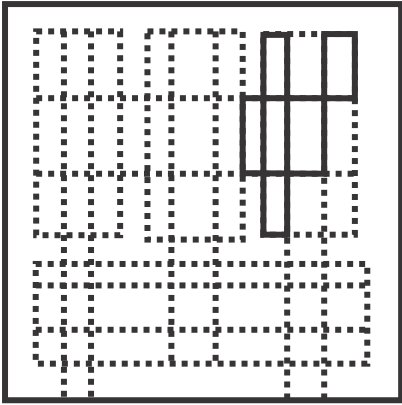

From the above, it is clear that the second option figure is embedded in the given question figure. Hence, the **second option** is correct.

**Q. 7** **Directions:** Select the option figure that is embedded in the given figure (rotation is NOT allowed).

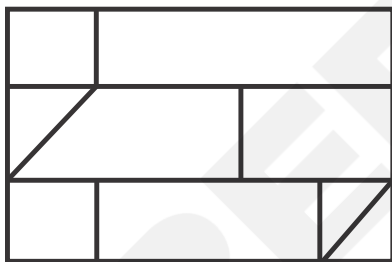

**Option 1:**

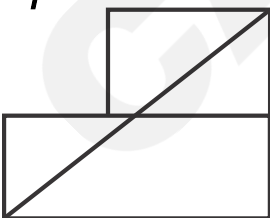

*Option 2:*

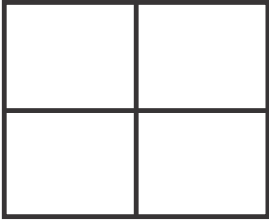

*Option 3:*

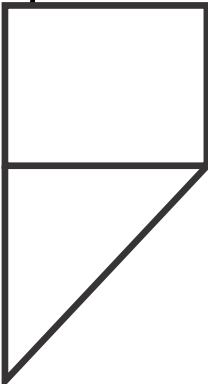

*Option 4:*

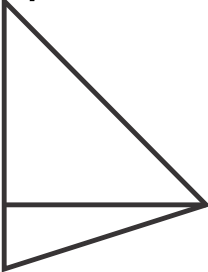

*Correct Answer:*

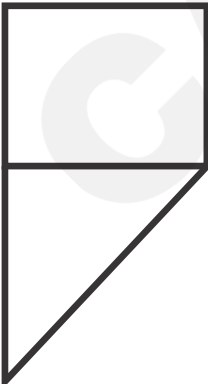

**Solution:**

Since the rotation of the figure is not allowed, let's check which option figure can exactly fit itself in the given question figure.

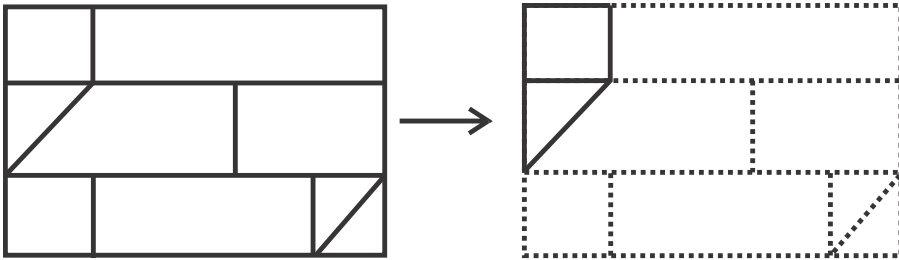

From the above, it is clear that the third option figure is embedded in the given question figure. Hence, the **third option** is correct.

- Q. 8** **Directions:** Select the option figure that is embedded in the given figure (rotation is NOT allowed).

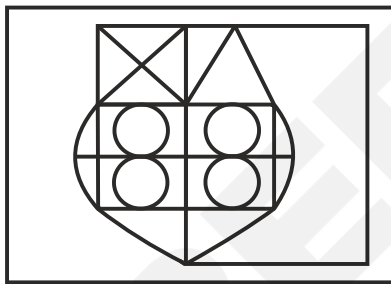

**Option 1:**

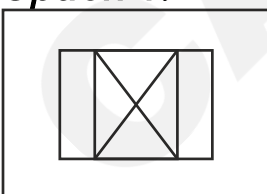

**Option 2:**

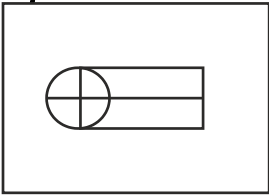

**Option 3:**

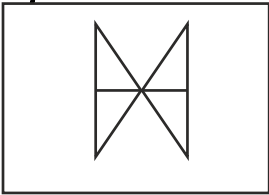

**Option 4:**

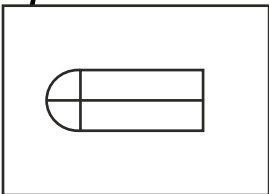

**Correct Answer:**

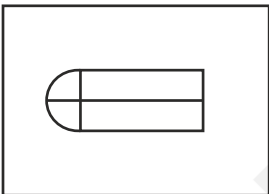

**Solution:**

Since the rotation of the figure is not allowed, let's check which option figure can exactly fit itself in the given question figure.

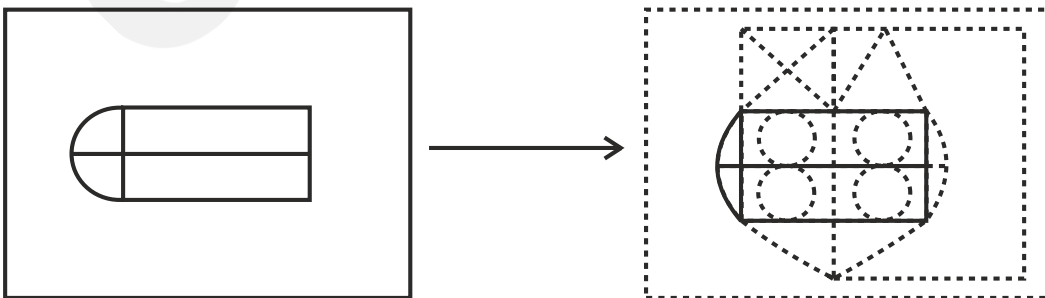

From the above, it is clear that the fourth option figure is embedded in the given question figure. Hence, the **fourth option** is correct.

- Q. 9** **Directions:** Select the option figure that is embedded in the given figure (rotation is NOT allowed).

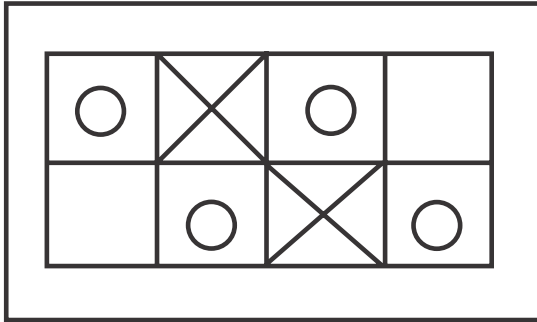

**Option 1:**

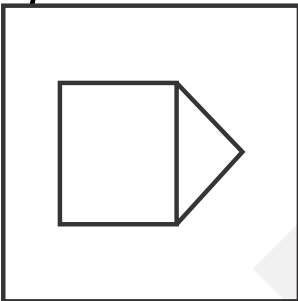

**Option 2:**

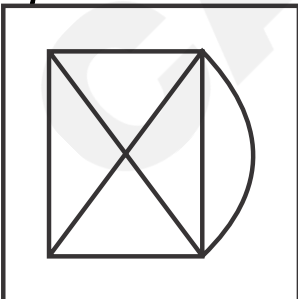

**Option 3:**



**Option 4:**

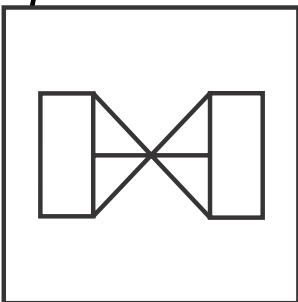

**Correct Answer:**

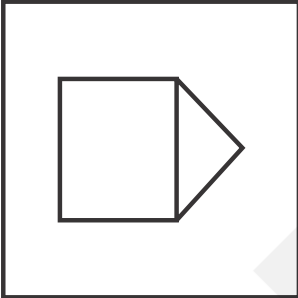

**Solution:**

Since the rotation of the figure is not allowed, let's check which of the option figures can exactly fit in the given question figure.

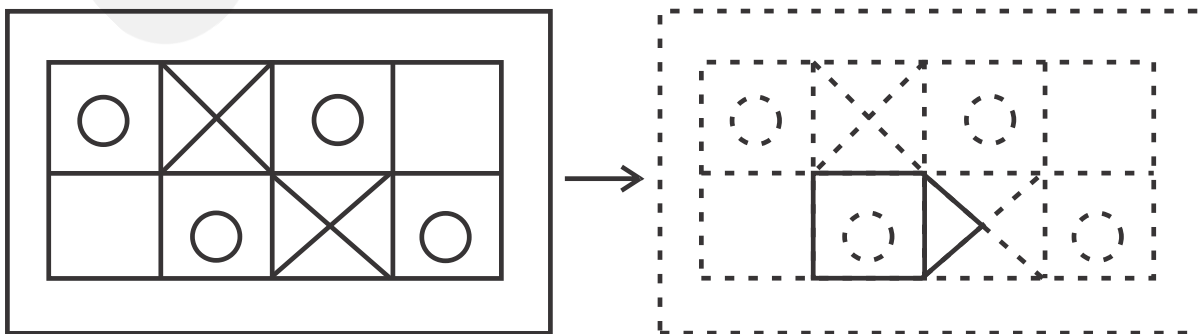

From the above, it is clear that the first option figure is embedded in the given question figure. Hence, the **first option** is correct.

**Q. 10** **Directions:** Select the option figure that is embedded in the given figure (Rotation is NOT allowed).

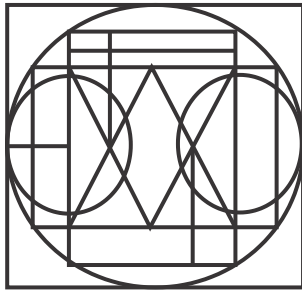

**Option 1:**

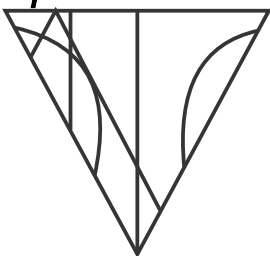

**Option 2:**

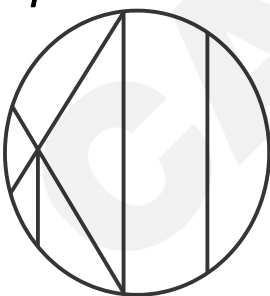

**Option 3:**

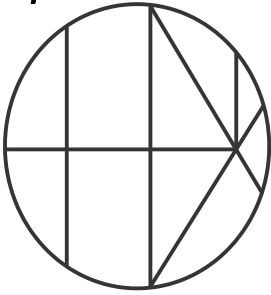

**Option 4:**

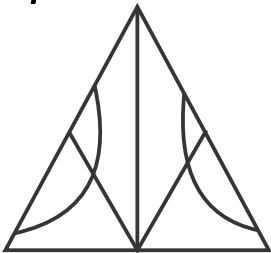

**Correct Answer:**

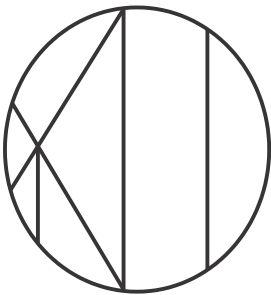

**Solution:**

Since the rotation is not allowed. So, the embedded figure will have the same orientation as the main figure. By comparison of all the option figures, only the second option figure is embedded in the given question figure.

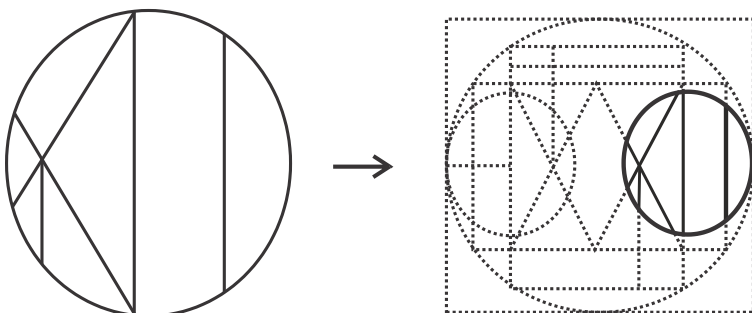

Hence, the **second option** is correct.

- Q. 11** **Directions:** Select the option figure in which the given figure is embedded (rotation is NOT allowed).

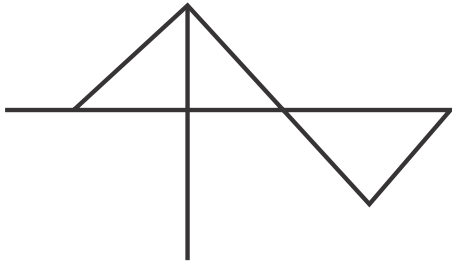

**Option 1:**

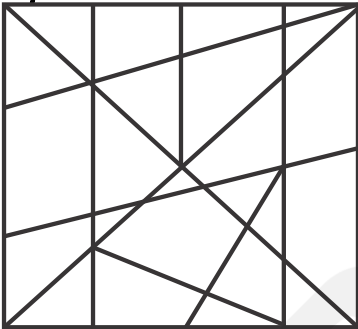

**Option 2:**

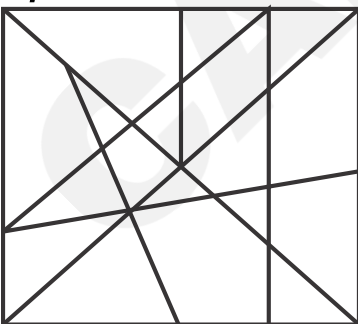

**Option 3:**

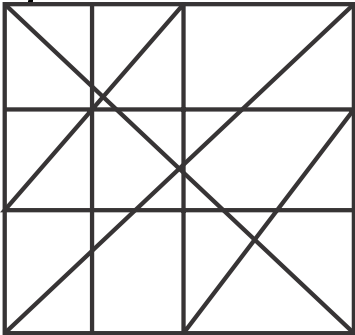

**Option 4:**

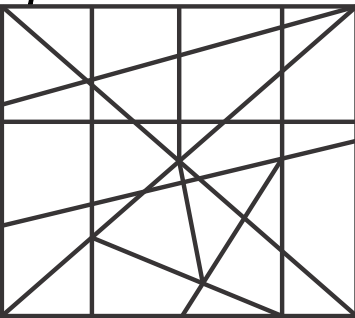

**Correct Answer:**

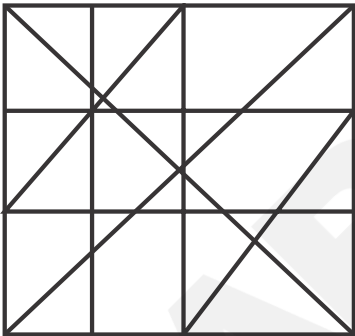

**Solution:**

Since the rotation of the figure is not allowed, so we will check where the question figure can exactly fit itself in the given option figures.

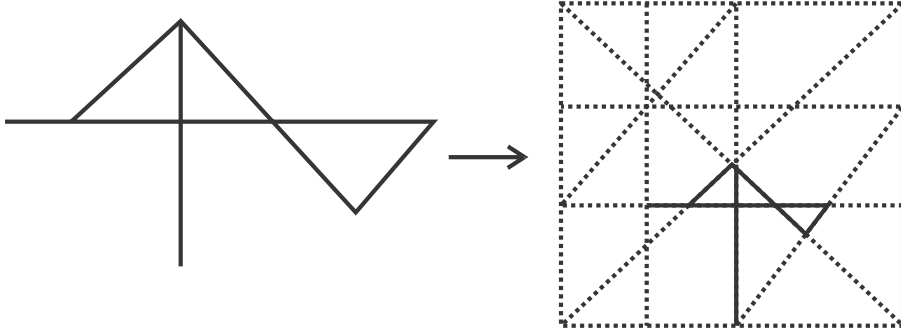

From the above, it is clear that the given question figure is embedded in the third option figure. Hence, the **third option** is correct.

**Q. 12** **Directions:** Select the option figure that is embedded in the given figure (rotation is NOT allowed).

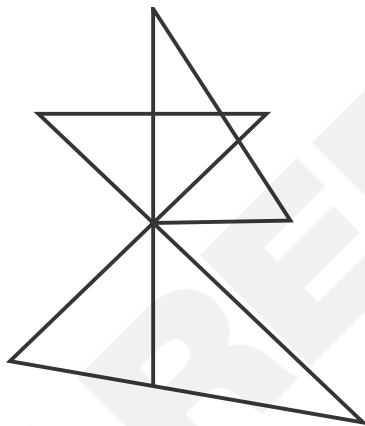

**Option 1:**

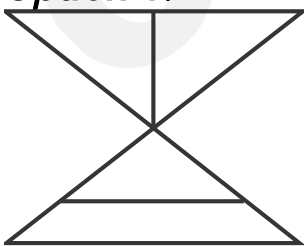

*Option 2:*

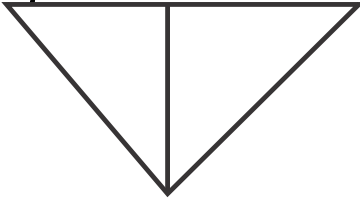

*Option 3:*

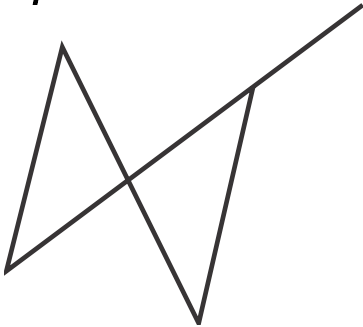

*Option 4:*



*Correct Answer:*

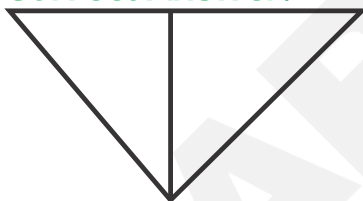

**Solution:**

Since the rotation is restricted. So, the embedded figure will have the same orientation as the main figure. By comparison of all the option figures, only the second option figure is embedded in the given question figure.

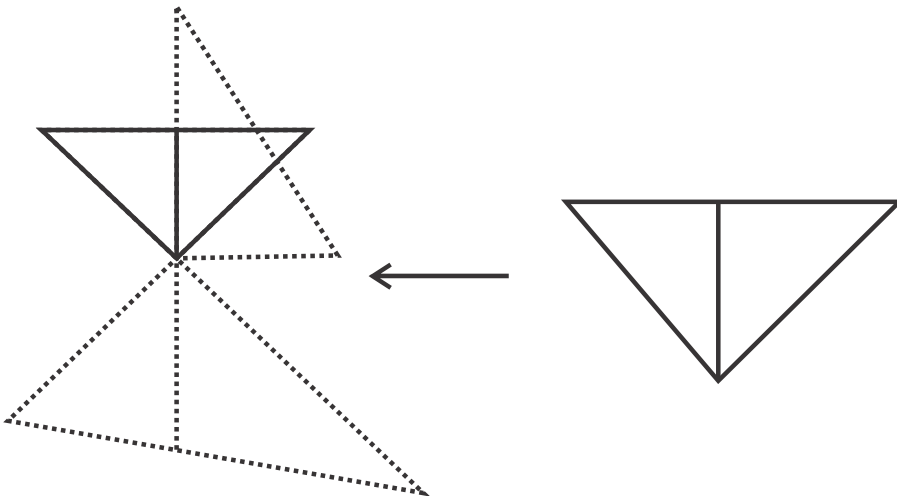

Hence, the **second option** is correct.

**Q. 13** **Directions:** Select the option figure that is embedded in the given figure (rotation is NOT allowed).

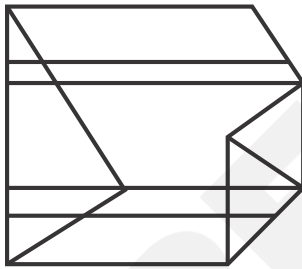

**Option 1:**



**Option 2:**

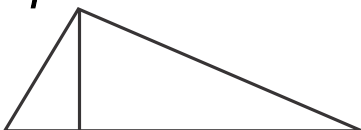

**Option 3:**

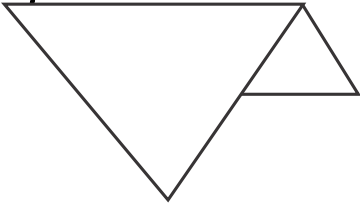

**Option 4:**

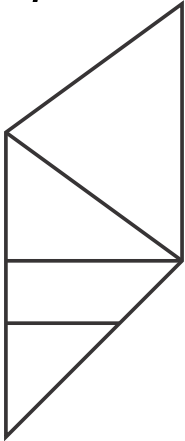

**Correct Answer:**

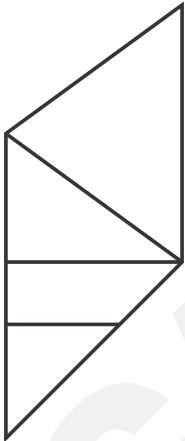

**Solution:**

Since the rotation is restricted. So, the embedded figure will have the same orientation as the main figure. By comparison of all the option figures, only the fourth option figure is embedded in the

given question figure.

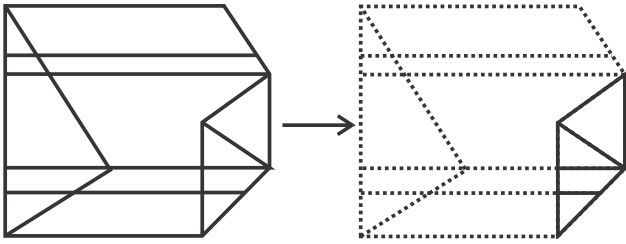

Hence, the **fourth option** is correct.

- Q. 14** **Directions:** Select the option figure that is embedded in the given figure (rotation is NOT allowed).

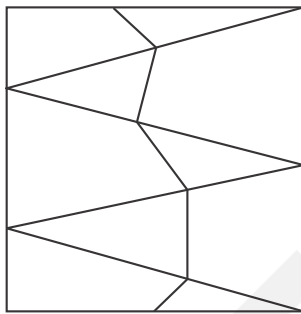

**Option 1:**



**Option 2:**



**Option 3:**

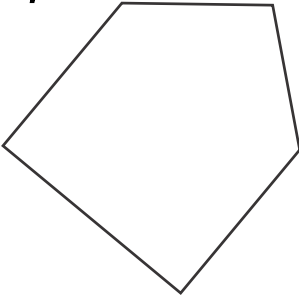

**Option 4:**

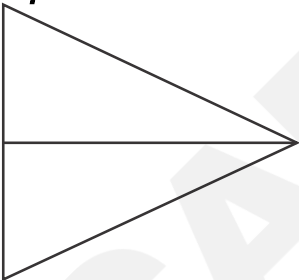

**Correct Answer:**



**Solution:**

Since the rotation is restricted. So, the embedded figure will have the same orientation as the main figure. By comparison of all the option figures, only the second option figure is embedded in the given question figure.

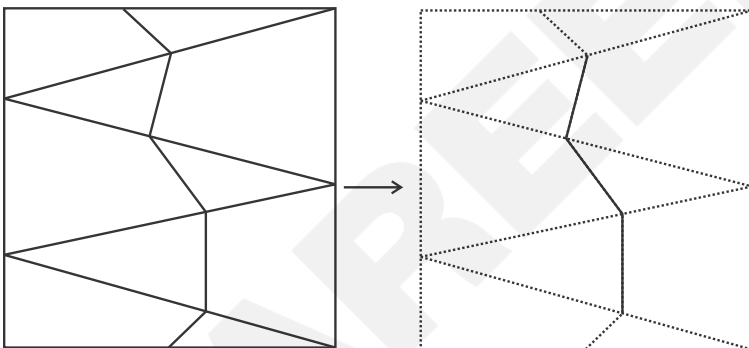

Hence, the **second option** is correct.

- Q. 15** **Directions:** Select the option figure which is embedded in the given figure. (Rotation is NOT allowed).



**Option 1:**

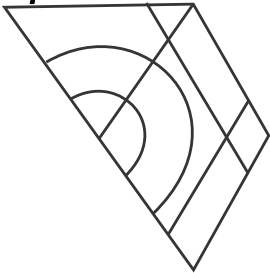

**Option 2:**

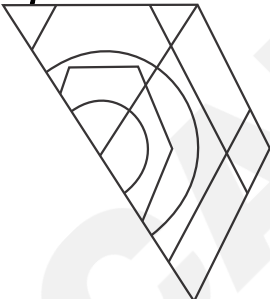

**Option 3:**

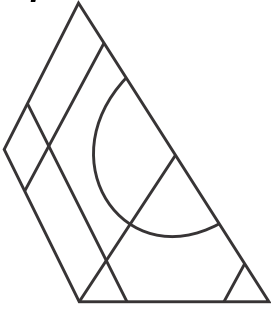

**Option 4:**

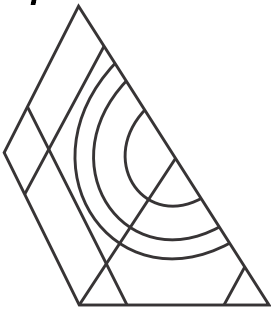

**Correct Answer:**

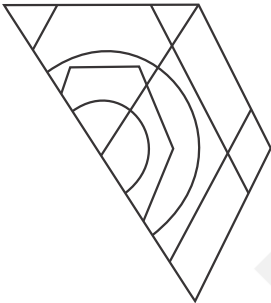

**Solution:**

Since the rotation of the figure is not allowed, we will check which of the option figures can exactly fit in the given question figure.

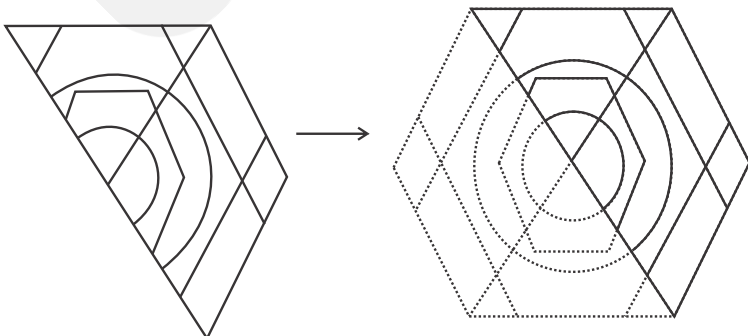

From the above, it is clear that the second option figure is embedded in the question figure. Hence, the **second option** is correct.

**Q. 16** **Directions:** Select the option figure that is embedded in the given figure (Rotation is NOT allowed).

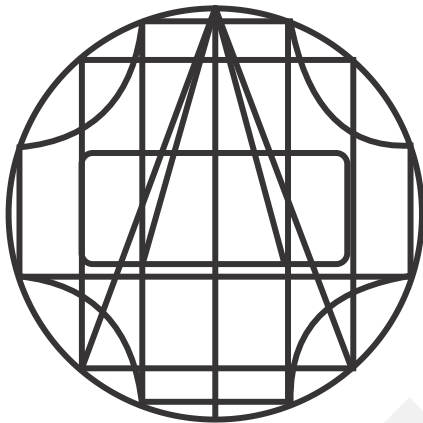

**Option 1:**

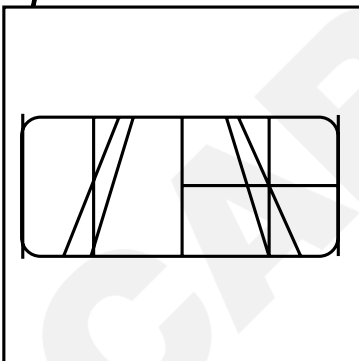

**Option 2:**

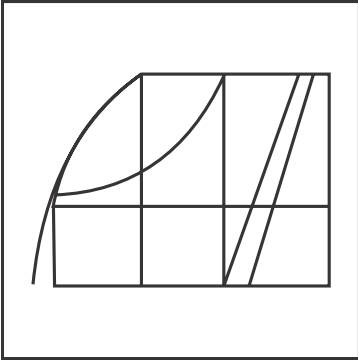

**Option 3:**

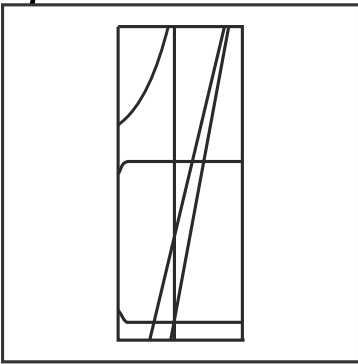

**Option 4:**

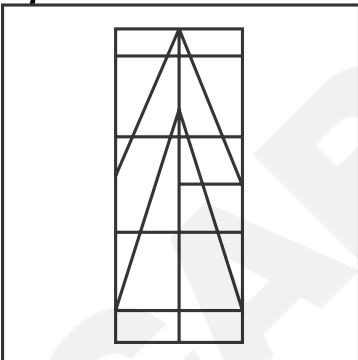

**Correct Answer:**

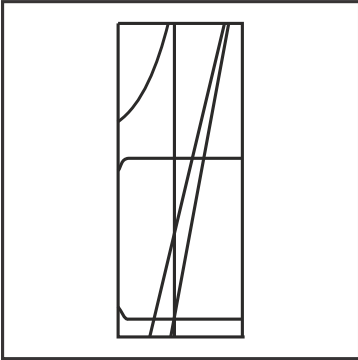

**Solution:**

As the rotation is restricted, the embedded figure will have the same orientation as the main figure. By comparison of all the option figures, only the third option figure is embedded in the given question figure.

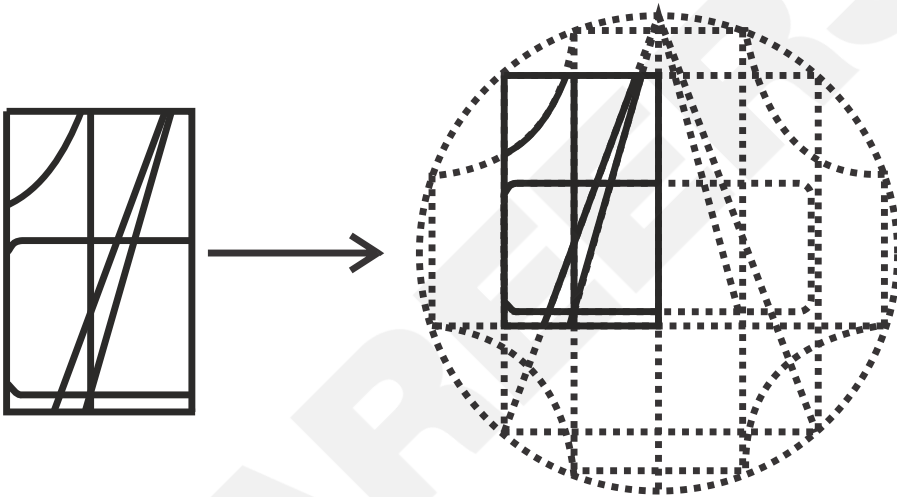

Hence, the **third option** is correct.

- Q. 17** **Directions:** Select the options figure which is embedded in the given figure (rotation is NOT allowed).

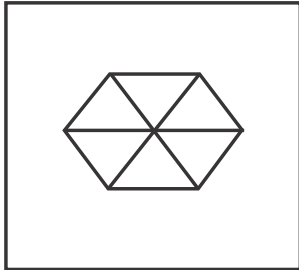

**Option 1:**

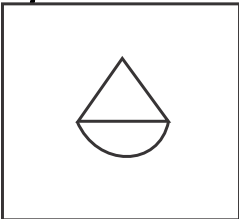

**Option 2:**

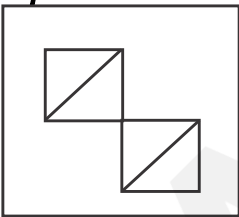

**Option 3:**

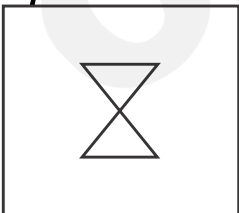

**Option 4:**

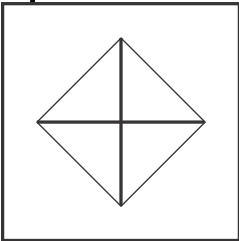

**Correct Answer:**

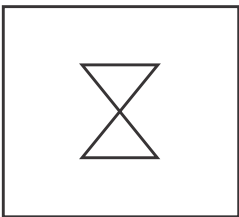

**Solution:**

Since the rotation is restricted. So, the embedded figure will have the same orientation as the main figure. By comparison of all the option figures, only the third option figure is embedded in the given question figure.

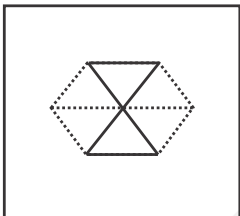

Hence, the **third option** is correct.

- Q. 18** **Directions:** Select the option figure that is embedded in the given figure (rotation is NOT allowed).

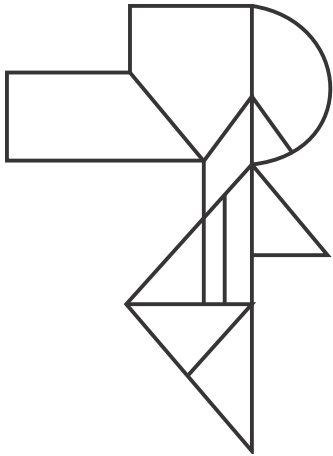

**Option 1:**

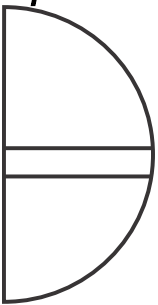

**Option 2:**



*Option 3:*

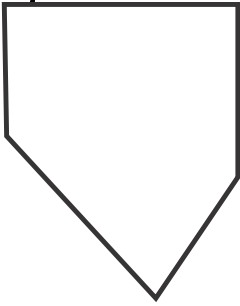

*Option 4:*

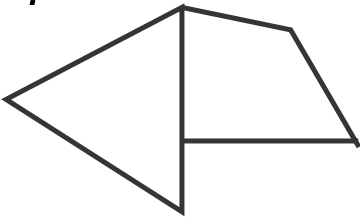

*Correct Answer:*

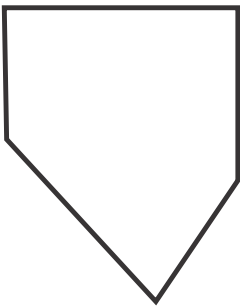

**Solution:**

Since the rotation is restricted. So, the embedded figure will have the same orientation as the main figure. By comparison of all the option figures, only the third option figure is embedded in the given question

figure.

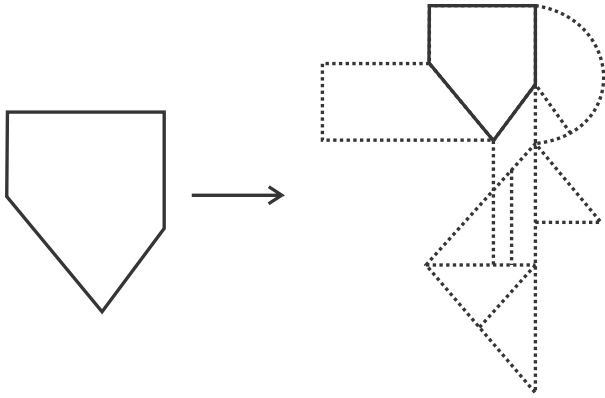

Hence, the **third option** is correct.

- Q. 19** **Directions:** From the given answer figures, select the one in which the question figure is hidden/embedded.



**Option 1:**

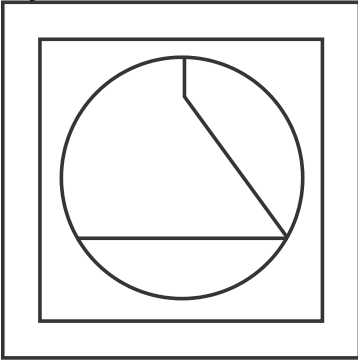

**Option 2:**

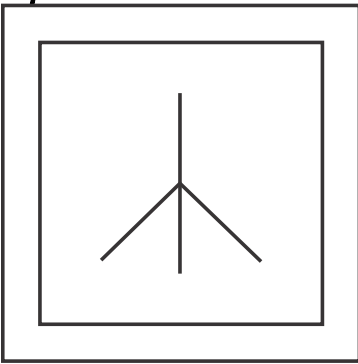

**Option 3:**

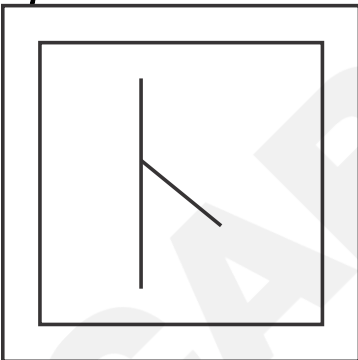

**Option 4:**

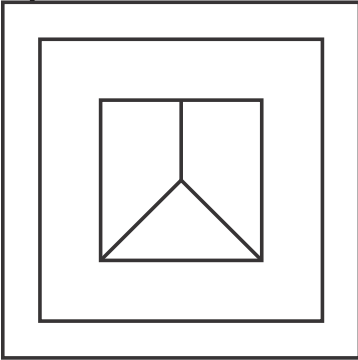

**Correct Answer:**

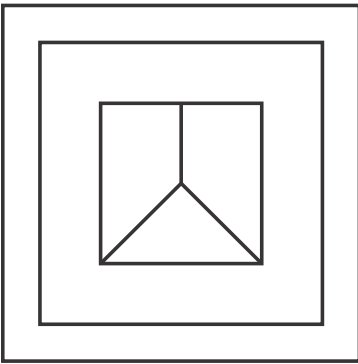

**Solution:**

Because there is no restriction on the rotation of the figure, we will check all the possible angles where the question figure can fit itself in the given option figures.

By comparison of all the option figures, the given question figure is embedded only in the fourth option figure.

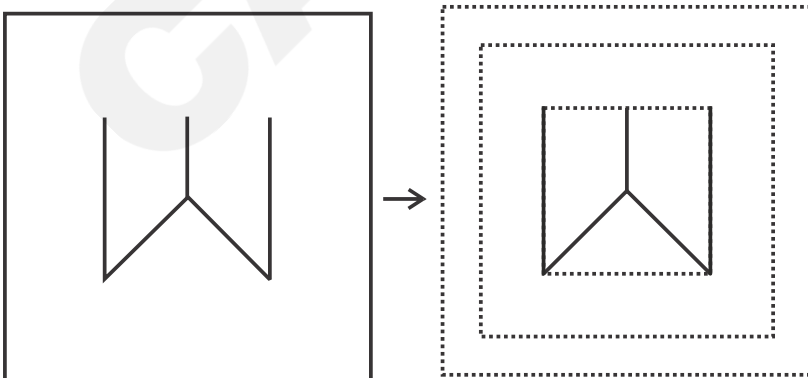

Hence, the **fourth option** is correct.

- Q. 20** **Directions:** Select the option figure that is embedded in the given figure. (Rotation is not allowed)

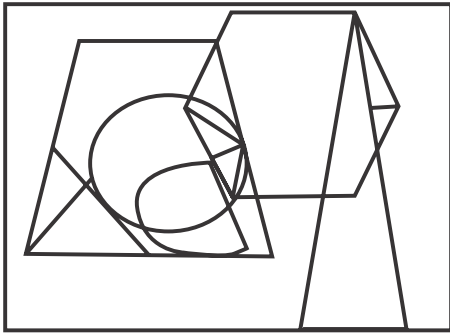

**Option 1:**

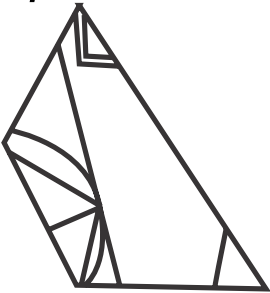

**Option 2:**



**Option 3:**



**Option 4:**

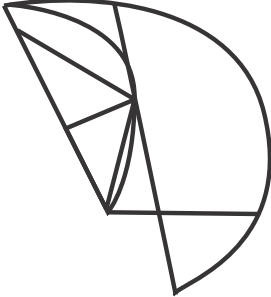

**Correct Answer:**



**Solution:**

Since the rotation is restricted. So, the embedded figure will have the same orientation as the main figure. By comparison of all the option figures, only the third option figure is embedded in the given question figure.

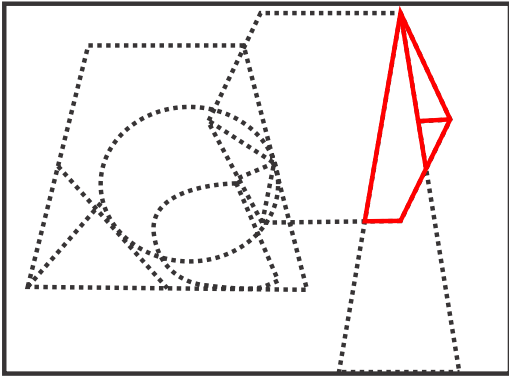

Hence, the **third option** is correct.

- Q. 21** **Directions:** Select the option figure that is embedded in the given figure as its part (rotation is NOT allowed).

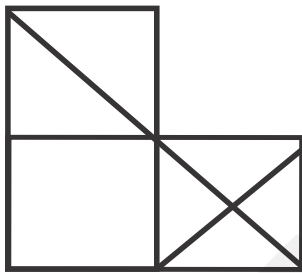

*Option 1:*



*Option 2:*

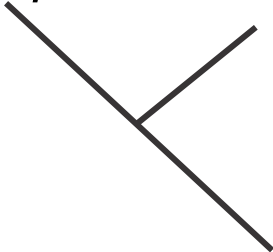

**Option 3:**

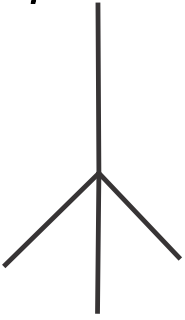

**Option 4:**

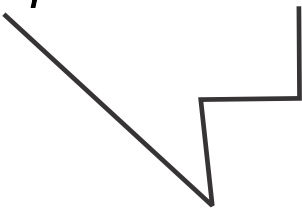

**Correct Answer:**

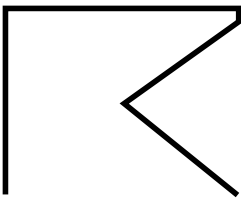

**Solution:**

Since the rotation is restricted. So, the embedded figure will have the same orientation as the main figure. By comparison of all the option figures, only the first option figure is embedded in the given question figure.

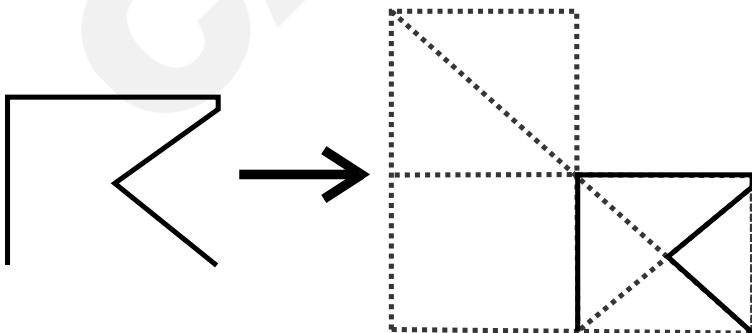

Hence, the **first option** is correct.

- Q. 22** **Directions:** Select the option figure that is embedded in the given figure (rotation is NOT allowed).

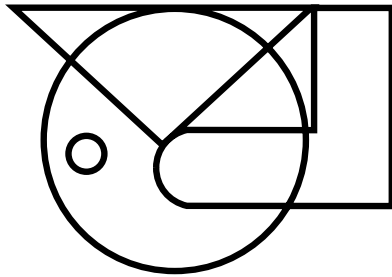

*Option 1:*

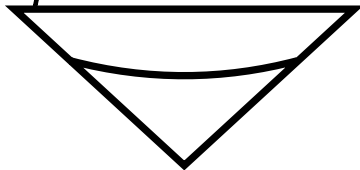

*Option 2:*

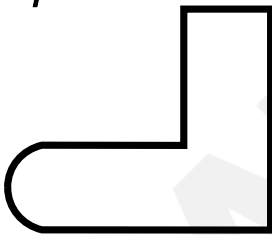

*Option 3:*



Option 4:

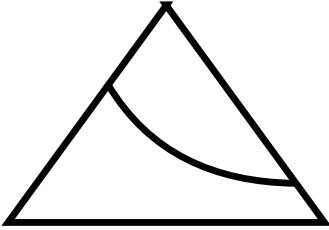

Correct Answer:

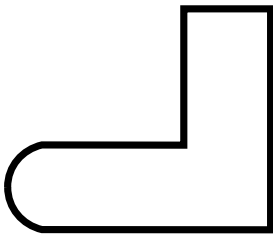

**Solution:**

Since the rotation is restricted. So, the embedded figure will have the same orientation as the main figure. By comparison of all the option figures, only the second option figure is embedded in the given question figure.

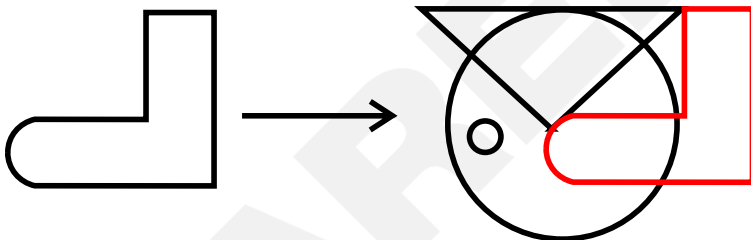

Hence, the **second option** is correct.

- Q. 23** **Directions:** Select the option figure that is embedded in the given figure. (Rotation is not allowed).

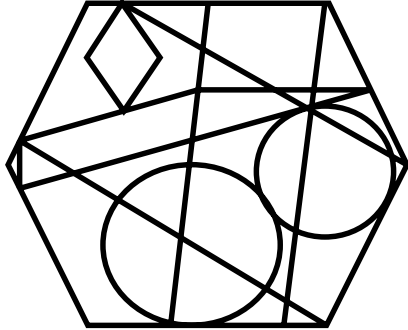

*Option 1:*

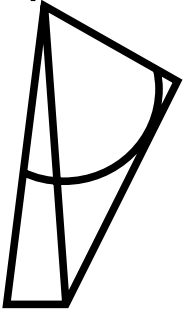

*Option 2:*



Option 3:

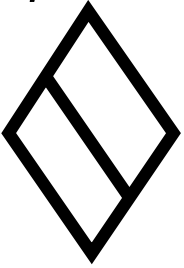

Option 4:

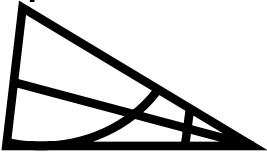

Correct Answer:

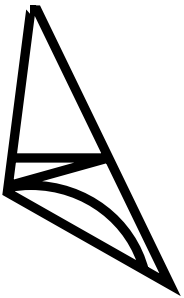

### Solution:

Since the rotation is restricted. So, the embedded figure will have the same orientation as the main figure. By comparison of all the option figures, only the second option figure is embedded in the given question figure.

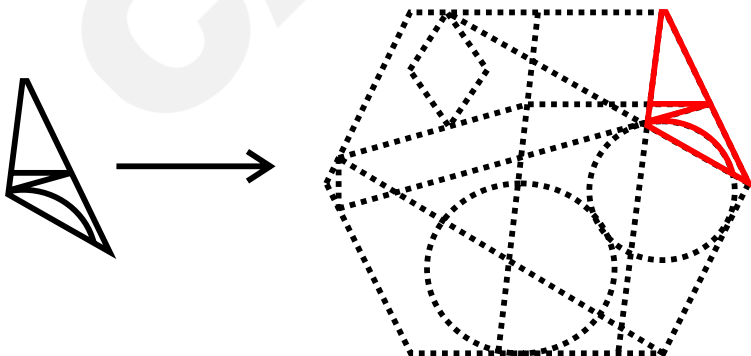

Hence, the **second option** is correct.

- Q. 24** **Directions:** Select the option figure that is embedded in the given figure (rotation is NOT allowed).

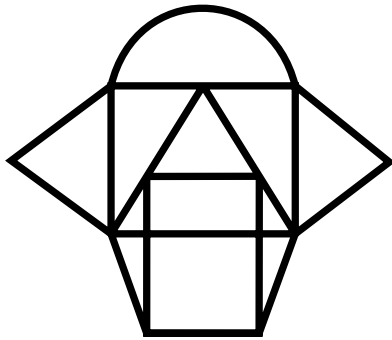

*Option 1:*

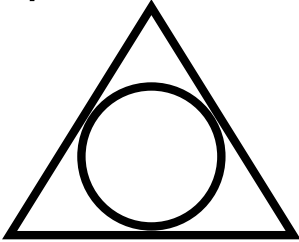

*Option 2:*



*Option 3:*

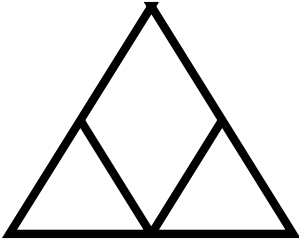

*Option 4:*

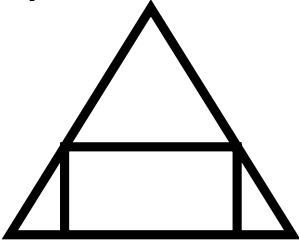

*Correct Answer:*

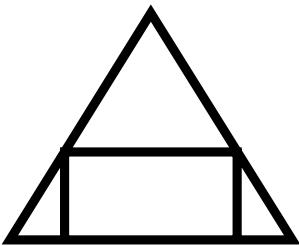

**Solution:**

Since the rotation is restricted. So, the embedded figure will have the same orientation as the main figure. By comparison of all the option figures, only the fourth option figure is embedded in the given question figure.

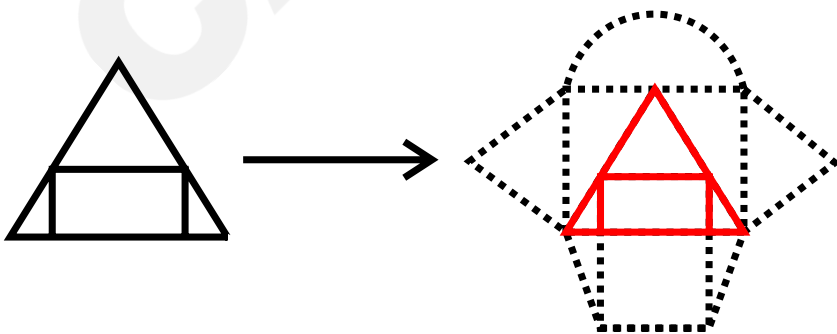

Hence, the **fourth option** is correct.

- Q. 25** **Directions:** Select the option figure that is embedded in the given figure (rotation is NOT allowed).

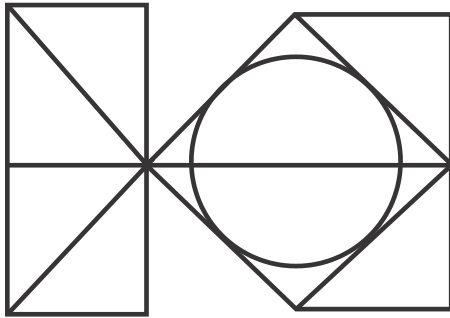

**Option 1:**

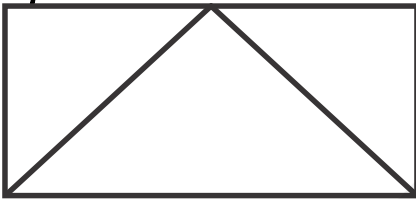

**Option 2:**

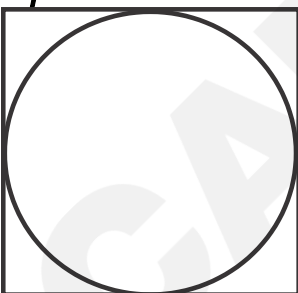

**Option 3:**

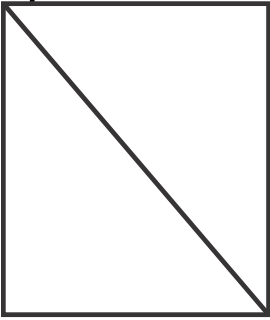

**Option 4:**

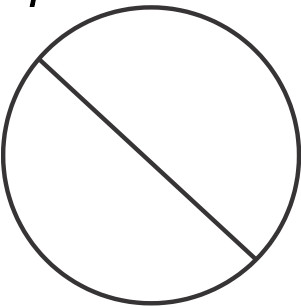

**Correct Answer:**

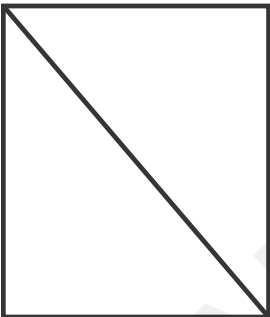

**Solution:**

Since the rotation is restricted. So, the embedded figure will have the same orientation as the main figure. By comparison of all the option figures, only the third option figure is embedded in the given question figure.

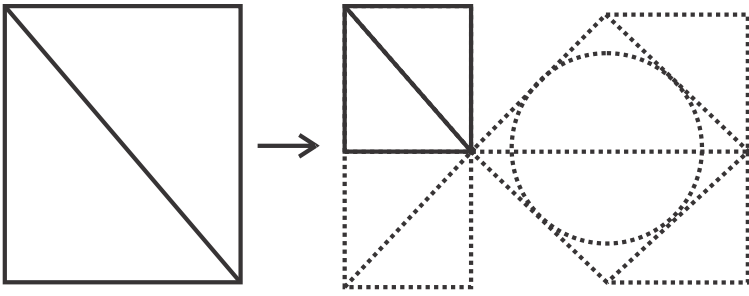

Hence, the **third option** is correct.

- Q. 26** **Directions:** Select the option figure that is embedded in the given figure. (Rotation is not allowed).

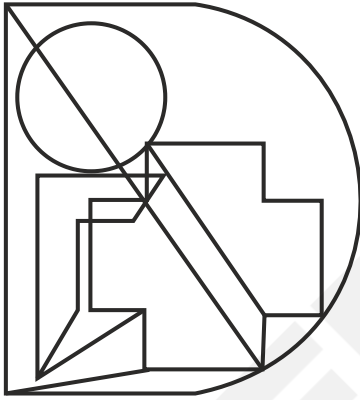

**Option 1:**

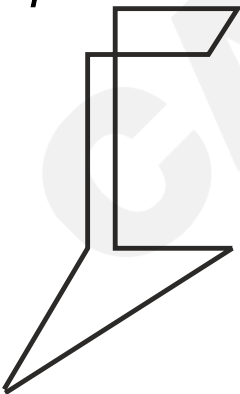

**Option 2:**

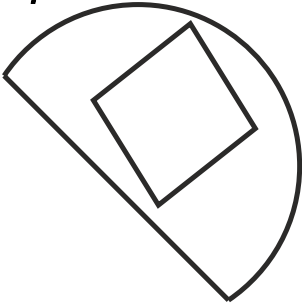

**Option 3:**

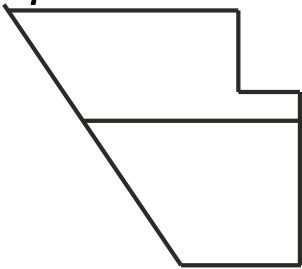

**Option 4:**

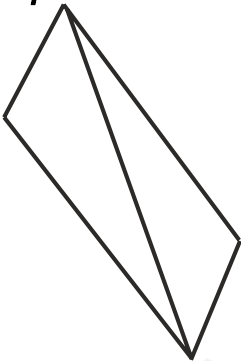

**Correct Answer:**

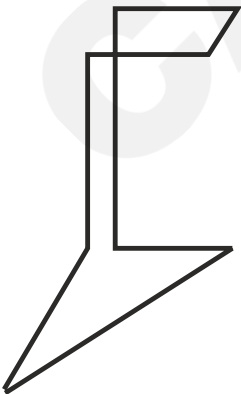

**Solution:**

Since the rotation is restricted. So, the embedded figure will have the same orientation as the main figure. By comparison of all the option figures, only the first option figure is embedded in the given question figure.

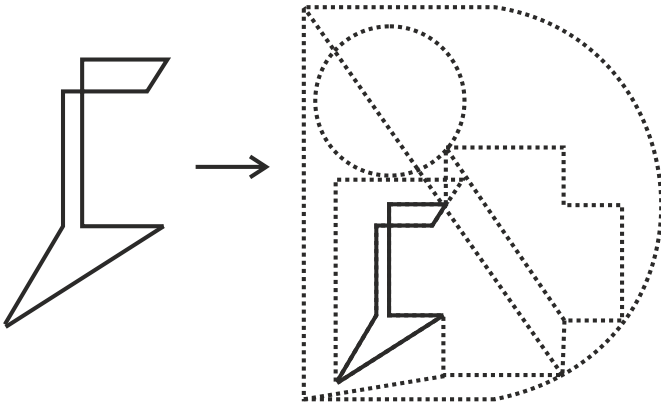

Hence, the **first option** is correct.

**Q. 27** **Directions:** Select the option figure that is embedded in the given figure (rotation is NOT allowed).

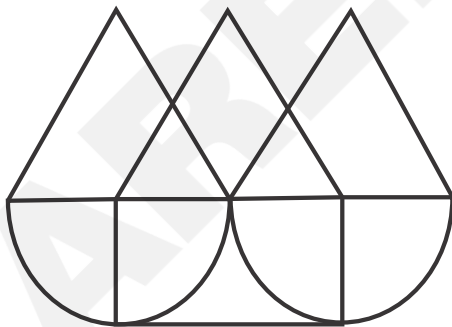

**Option 1:**

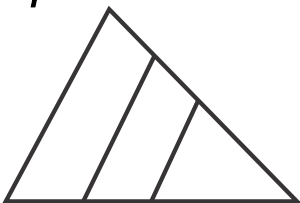

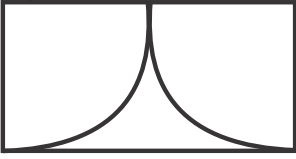
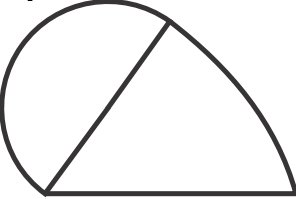
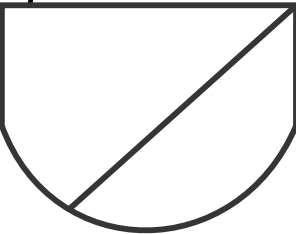
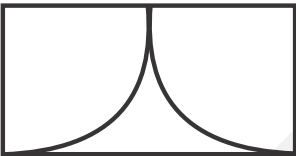
**Option 2:****Option 3:****Option 4:****Correct Answer:****Solution:**

Since the rotation is restricted. So, the embedded figure will have the same orientation as the main figure. By comparison of the question figure with all the option figures, only the second option figure is embedded in the given question figure.

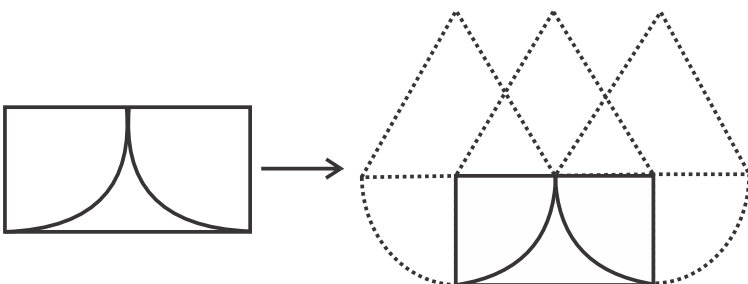

Hence, the **second option** is correct.

**Q. 28** **Directions:** Select the option figure that is embedded in the given figure as its part (rotation is NOT allowed).

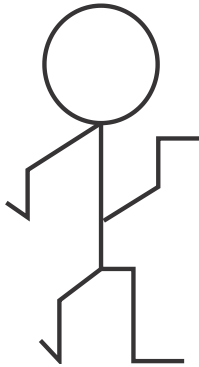

**Option 1:**



**Option 2:**

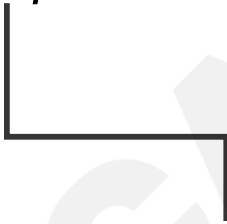

**Option 3:**



**Option 4:**

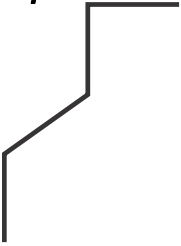

**Correct Answer:**

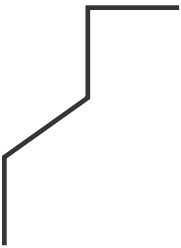

**Solution:**

Since the rotation is restricted. So, the embedded figure will have the same orientation as the main figure. By comparison of all the option figures, only the fourth option figure is embedded in the given question figure.

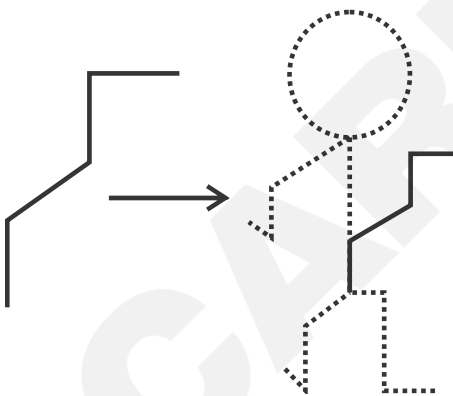

Hence, the **fourth option** is correct.

- Q. 29** **Directions:** Select the option figure that is embedded in the given figure. (Rotation is not allowed.)

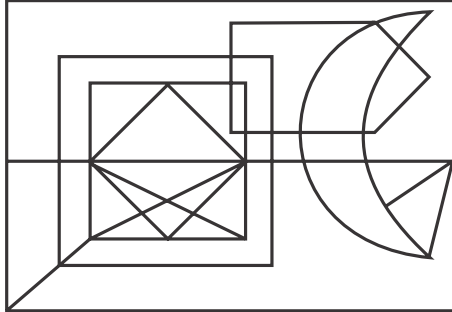

**Option 1:**

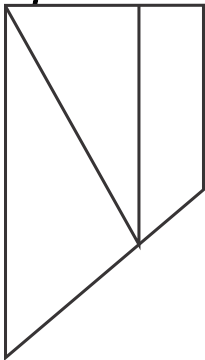

**Option 2:**

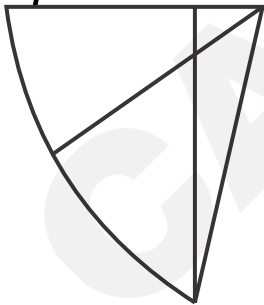

**Option 3:**

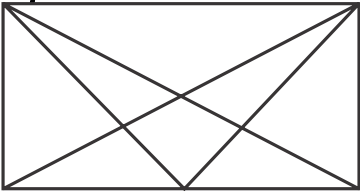

**Option 4:**

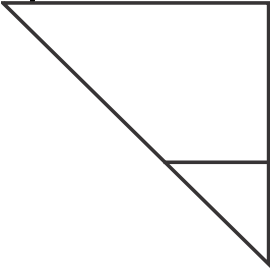

**Correct Answer:**

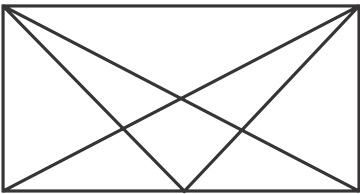

**Solution:**

Since the rotation is restricted. So, the embedded figure will have the same orientation as the main figure. By comparison of all the option figures, only the third option figure is embedded in the given question figure.

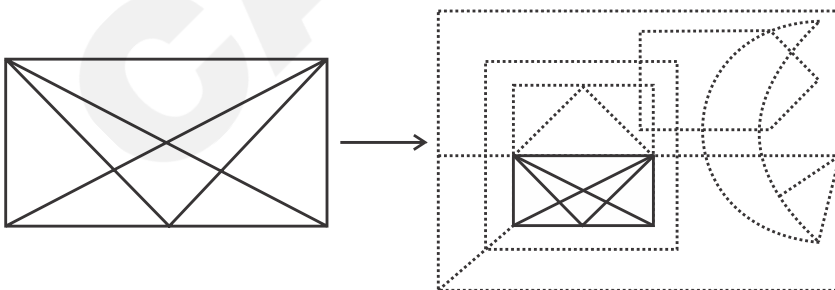

Hence, the **third option** is correct.

**Q. 30** **Directions:** Which of the answer figures is embedded in the question figure?

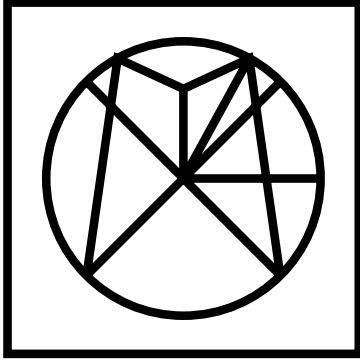

**Option 1:**

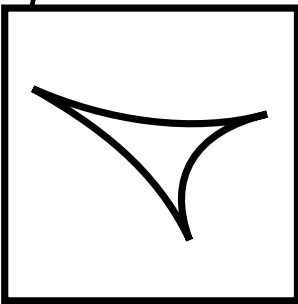

**Option 2:**

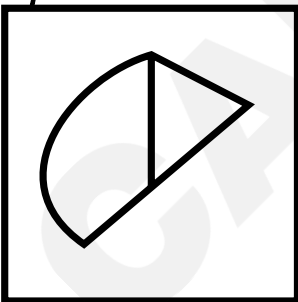

*Option 3:*

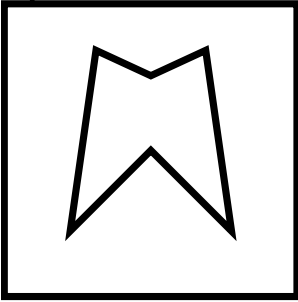

*Option 4:*

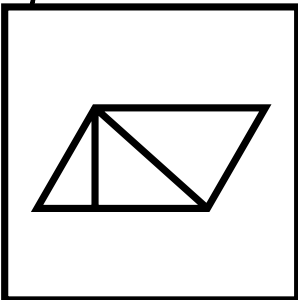

*Correct Answer:*

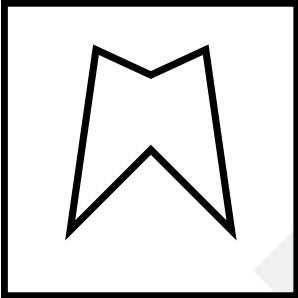

**Solution:**

Because there is no restriction on the rotation of the figure, we will check all possible orientations of the option figures to determine which one may fit in the question figure. By comparison of all the option figures, only the third option figure is embedded in the given question figure.

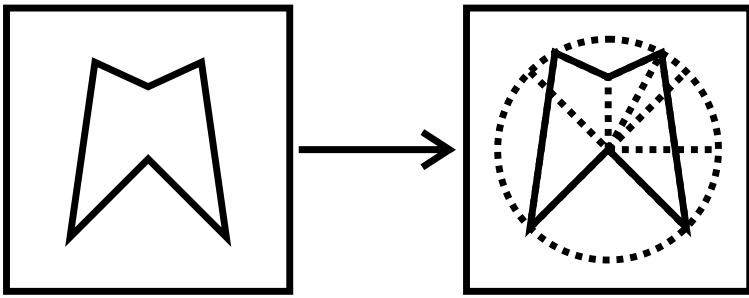

Hence, the **third option** is correct.

- Q. 31** **Directions:** Which of the answer figures is embedded in the question figure?

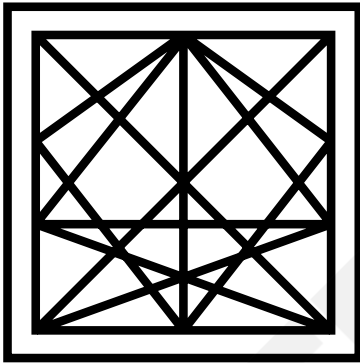

*Option 1:*

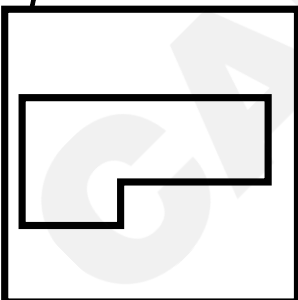

*Option 2:*

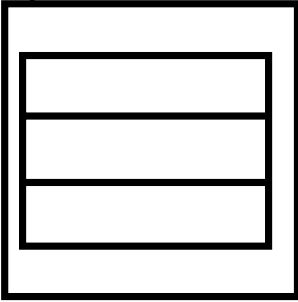

*Option 3:*

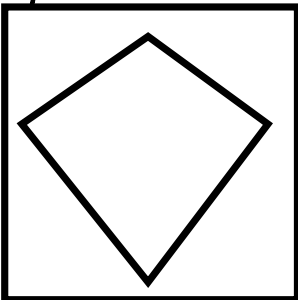

*Option 4:*

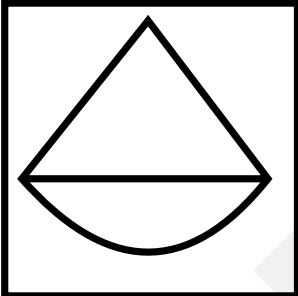

*Correct Answer:*

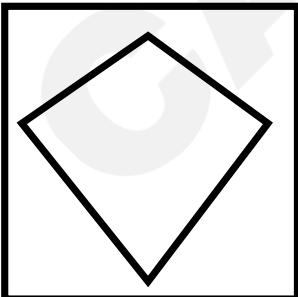

**Solution:**

Because there is no restriction on the rotation of the figure, we will check all possible orientations of the option figures to determine which one may fit in the question figure. By comparison of all the option figures, only the third option figure is embedded in the given question figure.

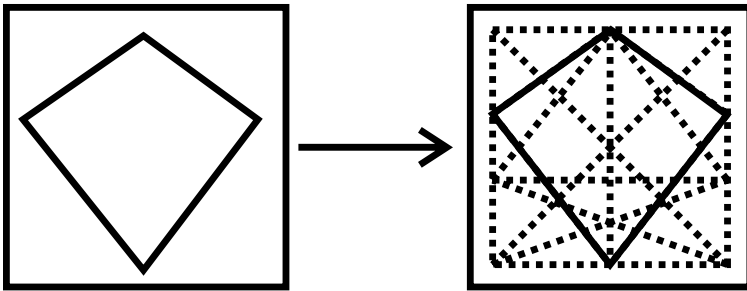

Hence, the **third option** is correct.

**Q. 32** **Directions:** Which of the answer figures is embedded in the question figure?

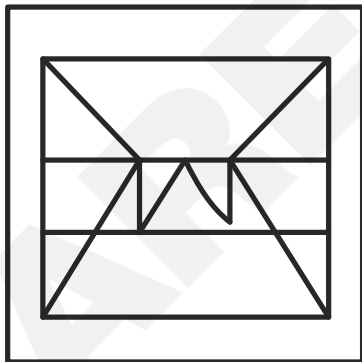

*Option 1:*

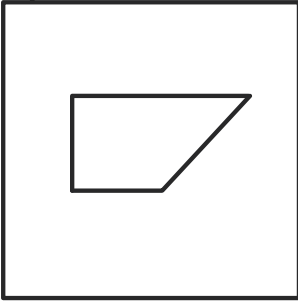

*Option 2:*

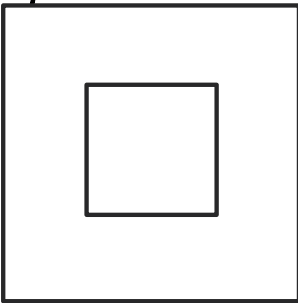

*Option 3:*



*Option 4:*

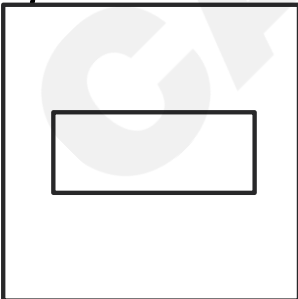

**Correct Answer:**

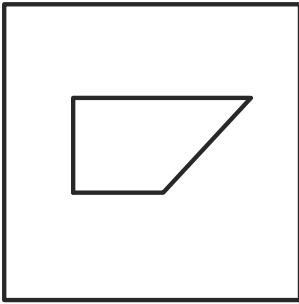

**Solution:**

Because there is no restriction on the rotation of the figure, we will check all possible orientations of the option figures to determine which one may fit in the question figure. By comparison of all the option figures, only the first option figure is embedded in the given question figure.

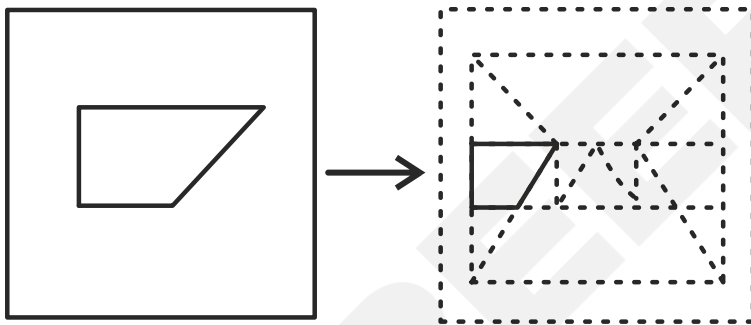

Hence, the **first option** is correct.

- Q. 33** **Directions:** Which of the following pieces will fit in the figure given below?

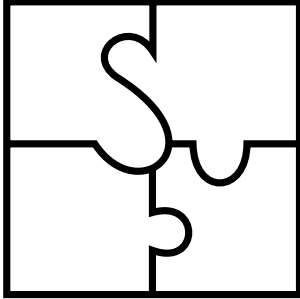

*Option 1:*

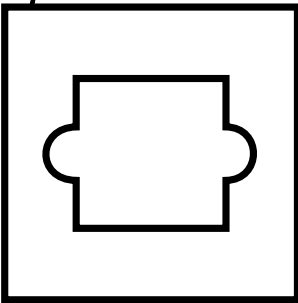

*Option 2:*

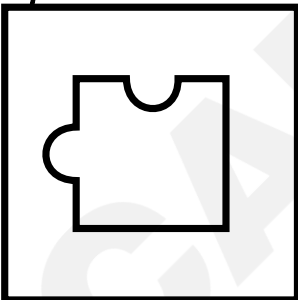

*Option 3:*

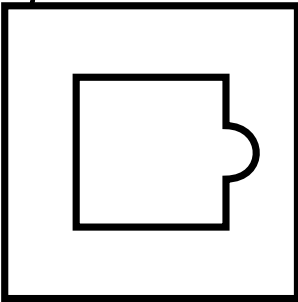

*Option 4:*

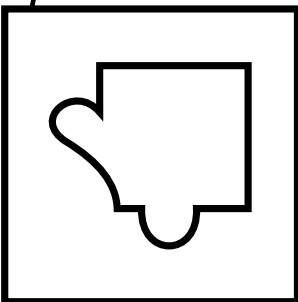

*Correct Answer:*

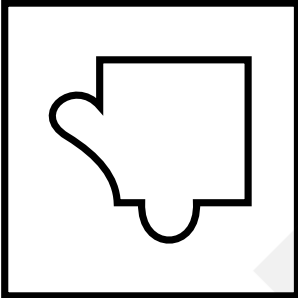

**Solution:**

Because there is no restriction on the rotation of the figure, we will check all possible orientations of the option figures to determine which one may fit in the question figure. By comparison of all the option figures, only the fourth option figure is embedded in the given question figure.

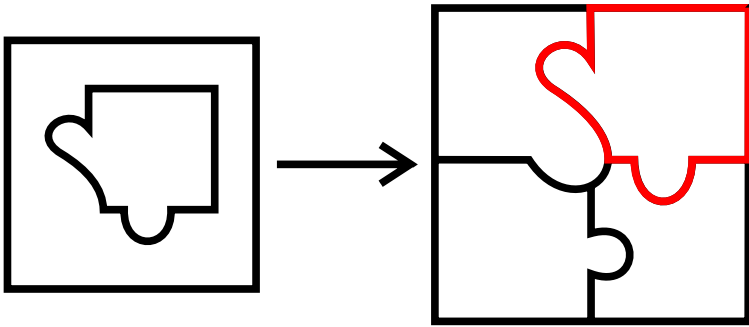

Hence, the **fourth option** is correct.

**Q. 34** **Directions:** Which of the given answer figures is hidden in the question figure?

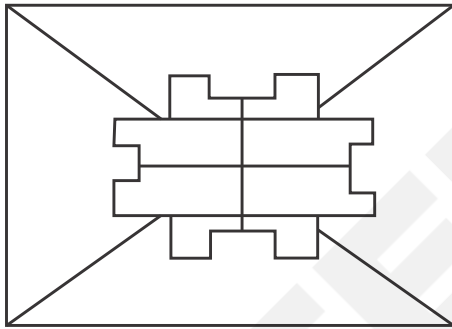

**Option 1:**

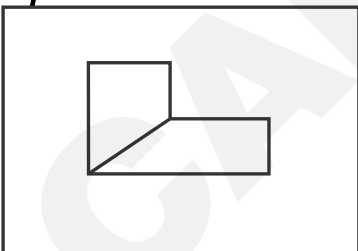

**Option 2:**

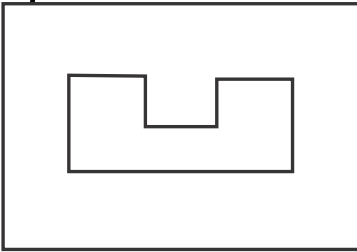

**Option 3:**

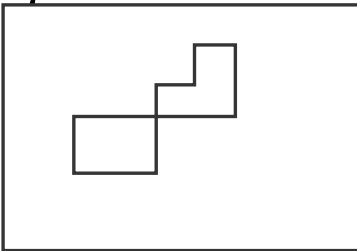

**Option 4:**

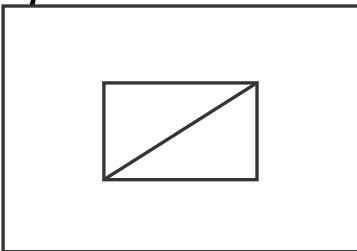

**Correct Answer:**

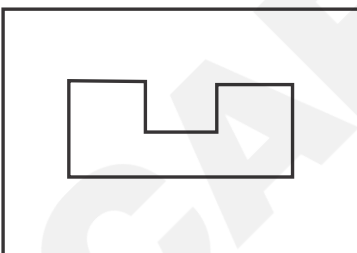

**Solution:**

Because there is no restriction on the rotation of the figure, we will check all possible orientations of the option figures to determine which one may fit in the question figure. By comparison of all the option figures, only the second option figure is embedded in the given question figure.

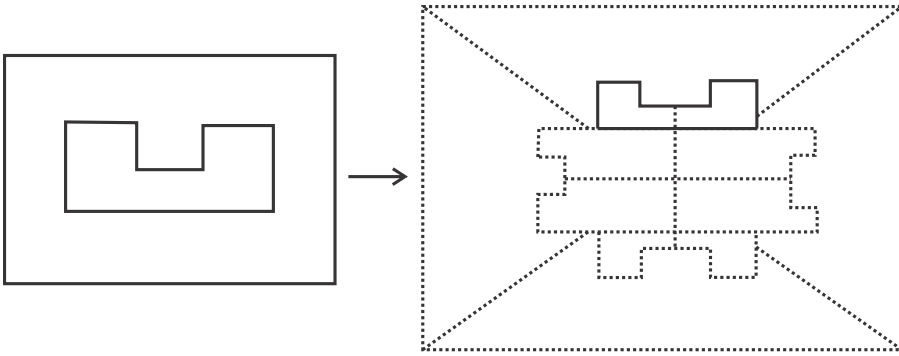

Hence, the **second option** is correct.

**Q. 35** **Directions:** Which of the answer figure is hidden/embedded in the question figure?

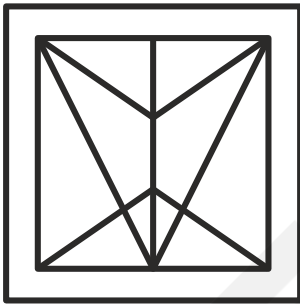

**Option 1:**



*Option 2:*

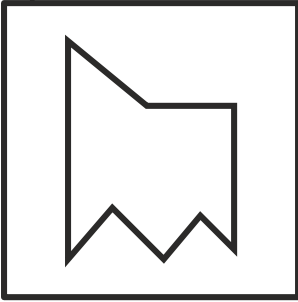

*Option 3:*

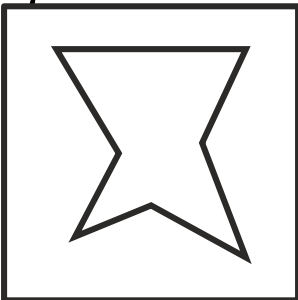

*Option 4:*

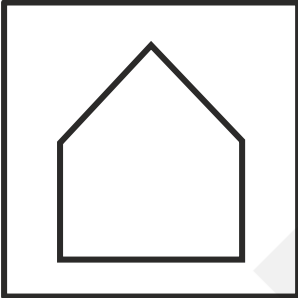

*Correct Answer:*



**Solution:**

Because there is no restriction on the rotation of the figure, we will check all possible orientations of the option figures to determine which one may fit in the question figure. By comparison of all the option figures, only the first option figure is embedded in the given question figure.

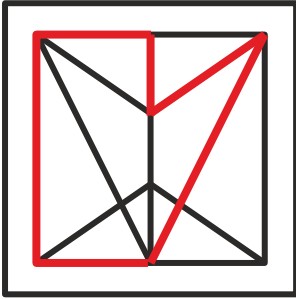

Hence, the **first option** is correct.

- 
- Q. 36**     **Directions:** Which of the answer figure is embedded in the question figure?

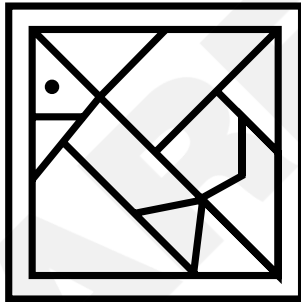

*Option 1:*

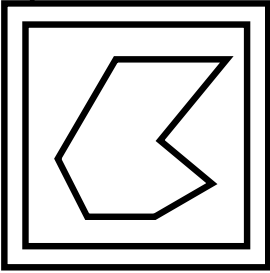

*Option 2:*

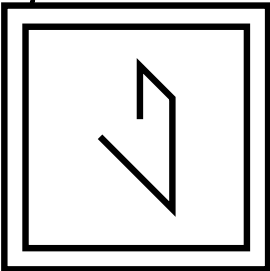

*Option 3:*

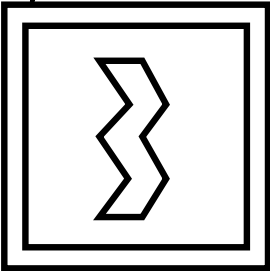

*Option 4:*

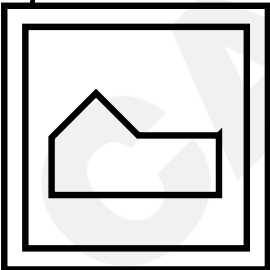

**Correct Answer:**

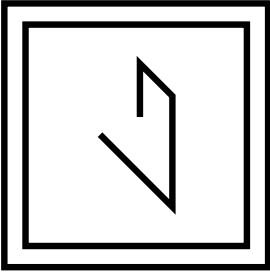

**Solution:**

Because there is no restriction on the rotation of the figure, we will check all possible orientations of the option figures to determine which one may fit in the question figure. By comparison of all the option figures, only the second option figure is embedded in the given question figure.

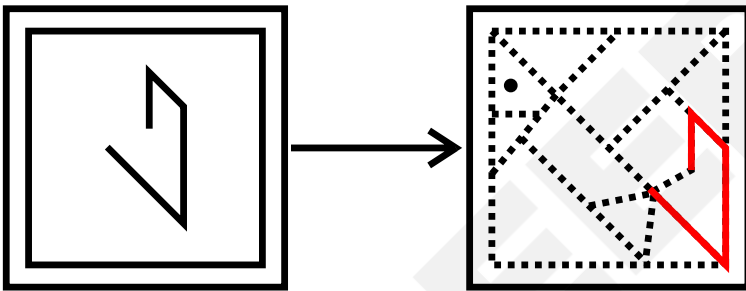

Hence, the **second option** is correct.

- Q. 37** **Directions:** Select the option figure that is embedded in the given figure (rotation is NOT allowed).

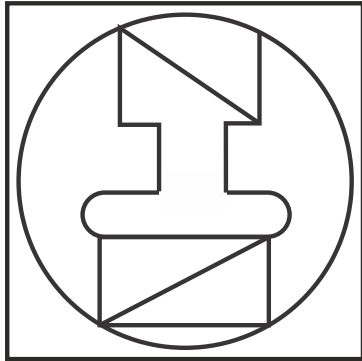

**Option 1:**

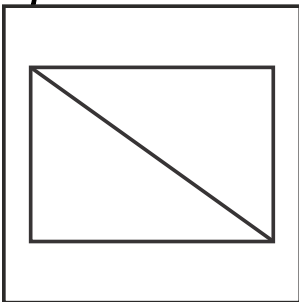

**Option 2:**

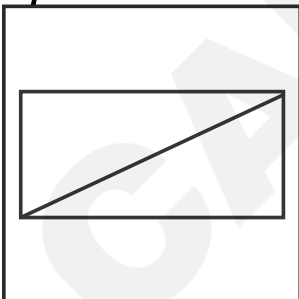

**Option 3:**

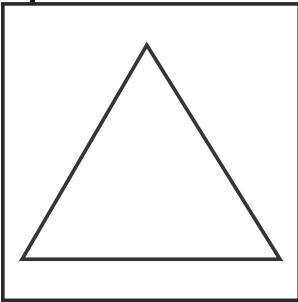

**Option 4:**

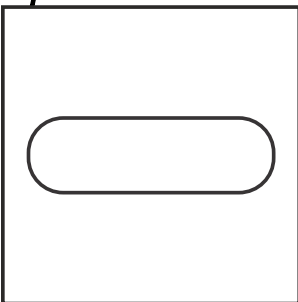

**Correct Answer:**

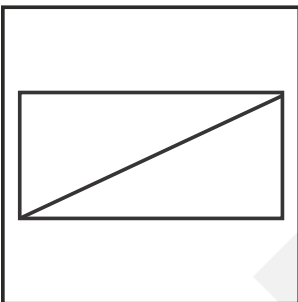

**Solution:**

Since the rotation is restricted. So, the embedded figure will have the same orientation as the main figure. By comparison of all the option figures, only the second option figure is embedded in the given question figure.

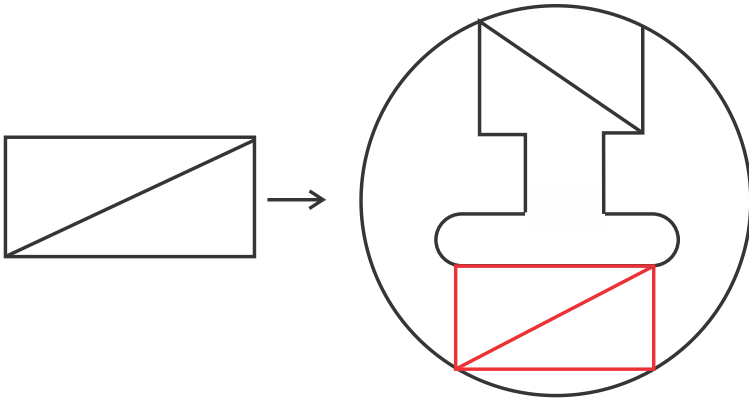

Hence, the **second option** is correct.

- Q. 38** **Directions:** Select the option figure that is NOT embedded in the figure (X) given below (rotation is NOT allowed).

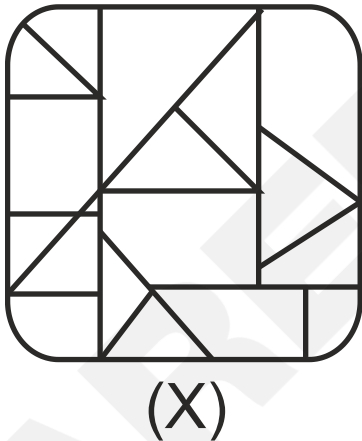

**Option 1:**

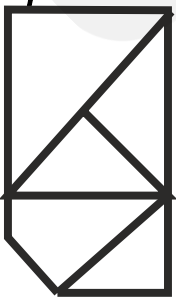

**Option 2:**

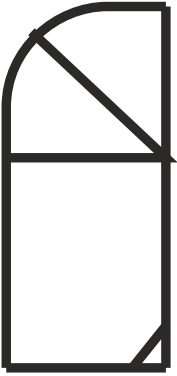

**Option 3:**

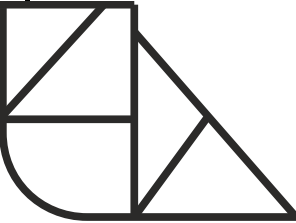

**Option 4:**

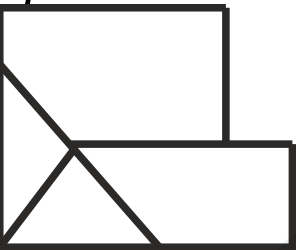

**Correct Answer:**

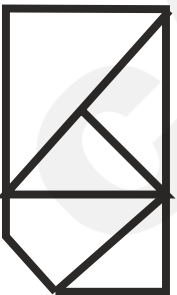

**Solution:**

Let's check each option –

**First option:** The given figure is not embedded in the question figure.

**Second option:**

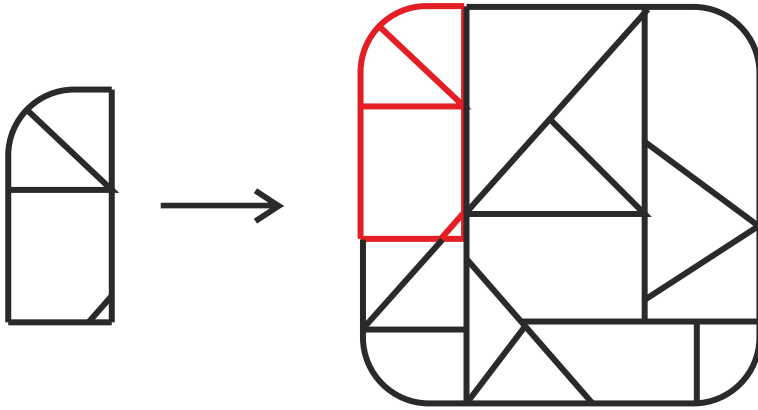

This figure is embedded in the given question figure.

**Third option:**

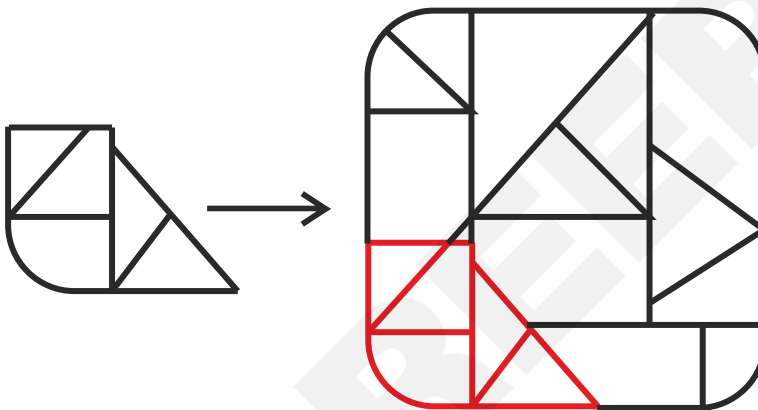

This figure is embedded in the given question figure.

**Fourth option:**

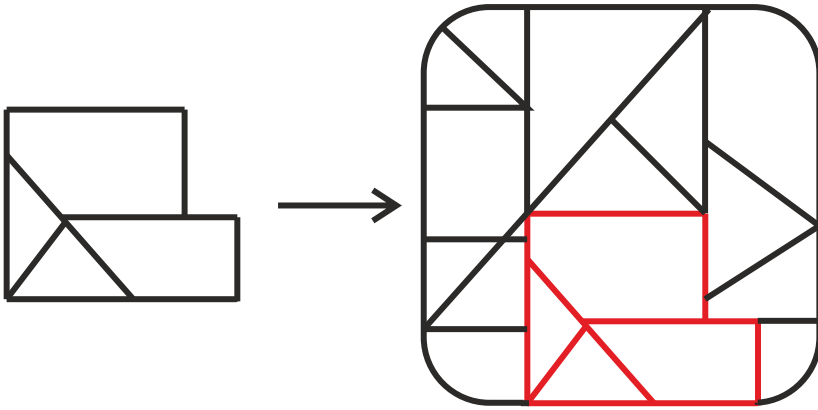

This figure is embedded in the given question figure.

So, only the first option is not embedded in the given question figure. Hence, the **first option** is correct.

- Q. 39** **Directions:** Select the option figure that is embedded in the figure (X) given below (rotation is not allowed).

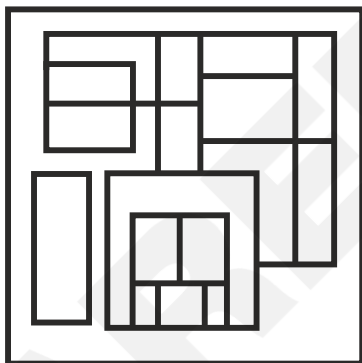

(X)

*Option 1:*

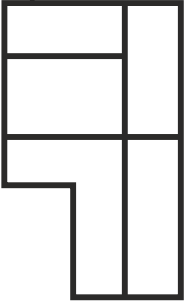

*Option 2:*

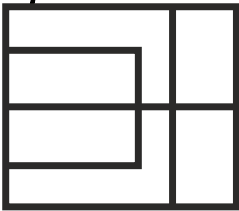

*Option 3:*

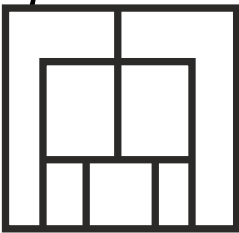

*Option 4:*



**Correct Answer:**

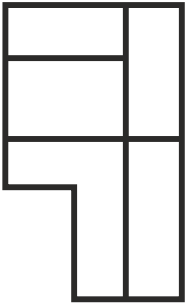

**Solution:**

Since there is a restriction on the rotation of the figure, we will check which of the option figures can exactly fit in the given question figure.

By comparison of all the option figures, only the first option figure is embedded in the given question figure.

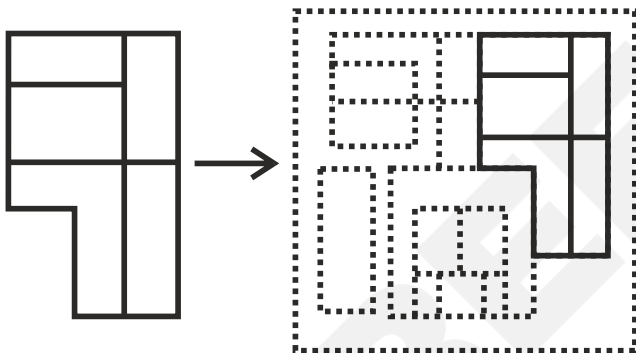

Hence, the **first option** is correct.

- Q. 40** **Directions:** Select the option figure that is embedded in the figure (X) given below (rotation is NOT allowed).

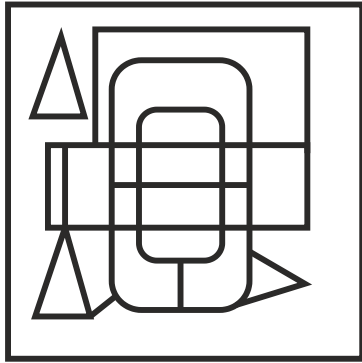

(X)

*Option 1:*

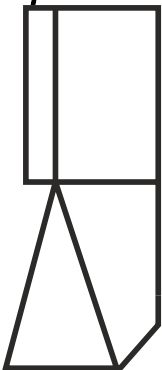

*Option 2:*

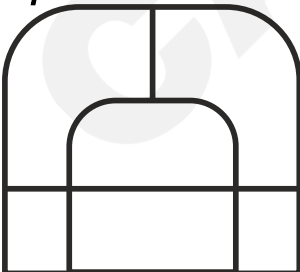

**Option 3:**

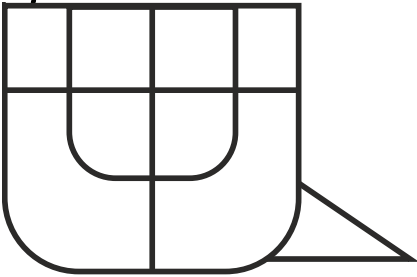

**Option 4:**

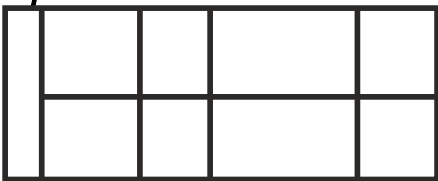

**Correct Answer:**

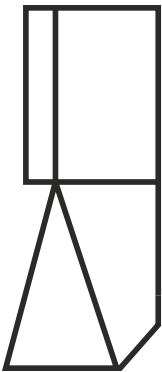

**Solution:**

Since there is a restriction on the rotation of the figure, we will check which of the option figures can exactly fit in the given question figure.

By comparison of all the option figures, only the first option figure is embedded in the given question figure.

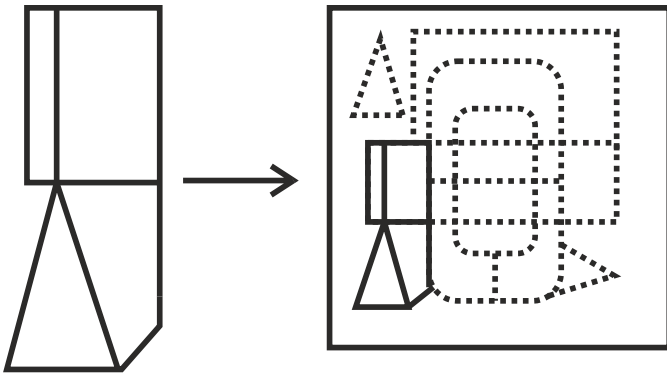

Hence, the **first option** is correct.

- Q. 41** **Directions:** Identify the option that is embedded in the following figure (rotation is NOT allowed).

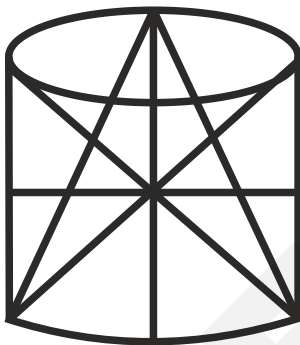

*Option 1:*

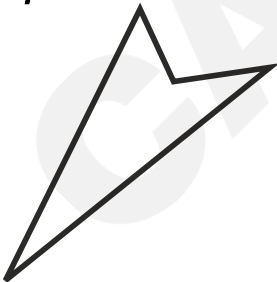

Option 2:

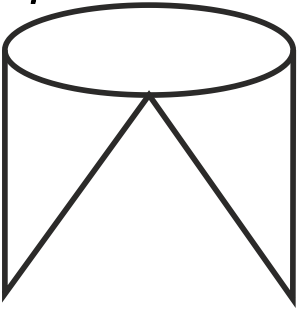

Option 3:

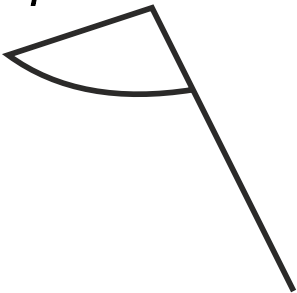

Option 4:



Correct Answer:

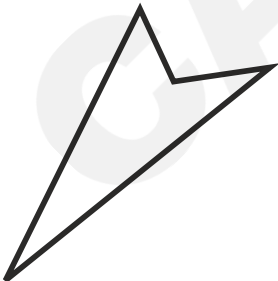

Solution:

Since there is a restriction on the rotation of the figure, we will check which of the option figures can exactly fit in the given question figure.

By comparison of all the option figures, only the first option figure is embedded in the given question figure.

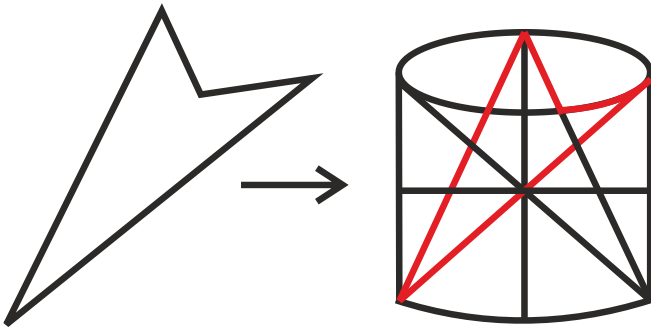

Hence, the **first option** is correct.

**Q. 42** **Directions:** Identify the option that is embedded in the following figure (rotation is NOT allowed).

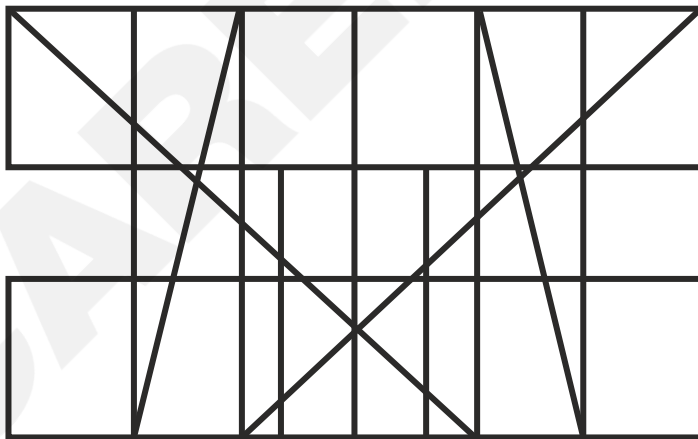

**Option 1:**

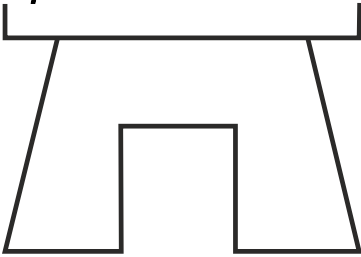

**Option 2:**

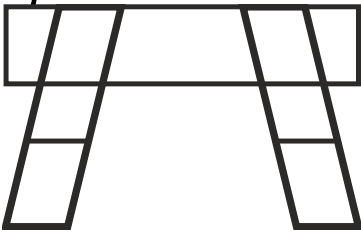

**Option 3:**

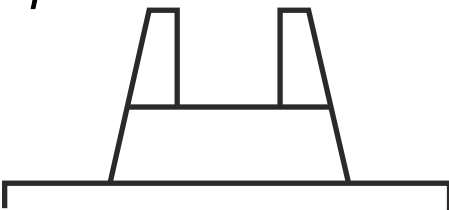

**Option 4:**

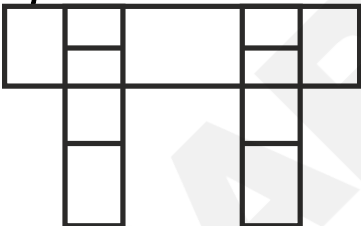

**Correct Answer:**

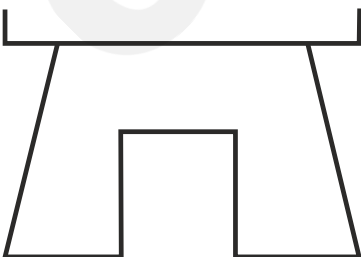

**Solution:**

Since there is a restriction on the rotation of the figure, we will check which of the option figures can exactly fit in the given question figure.

By comparison of all the option figures, only the first option figure is embedded in the given question figure.

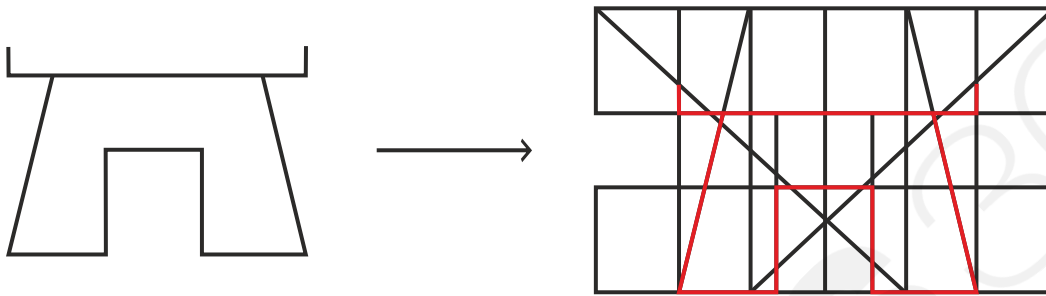

Hence, the **first option** is correct.

- Q. 43** **Directions:** Identify the option figure that is embedded in the figure given below (rotation is NOT allowed).

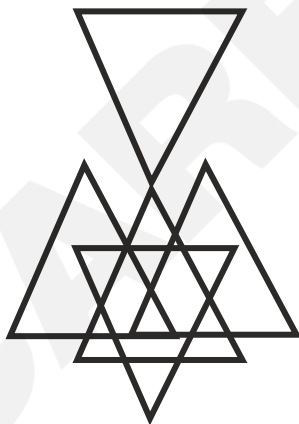

Option 1:

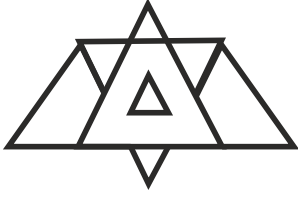

Option 2:



Option 3:

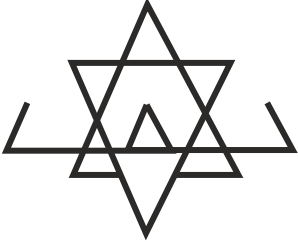

Option 4:



Correct Answer:



Solution:

Since there is a restriction on the rotation of the figure, we will check which of the option figures can exactly fit in the given question figure.

By comparison of all the option figures, only the third option figure is embedded in the given question figure.

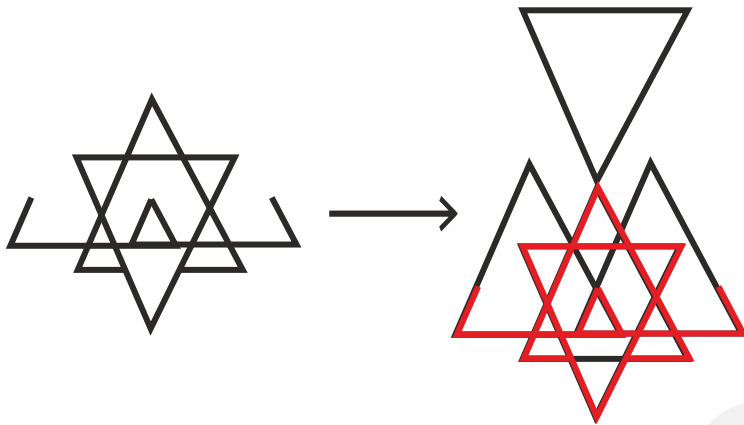

Hence, the **third option** is correct.

**Q. 44** **Directions:** Select the option that is embedded in the given figure. (Rotation is NOT allowed)

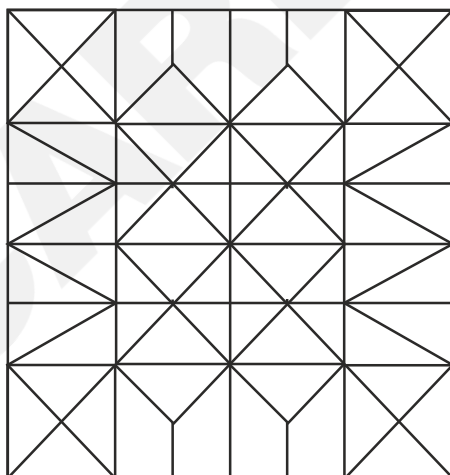

**Option 1:**

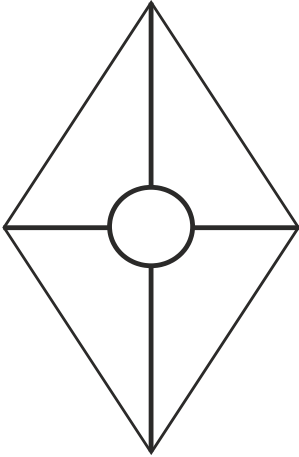

**Option 2:**

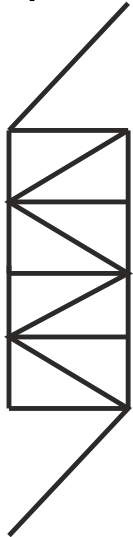

**Option 3:**

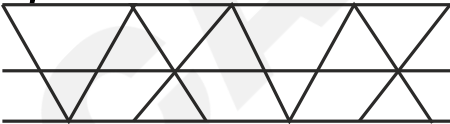

**Option 4:**

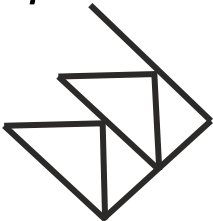

**Correct Answer:**

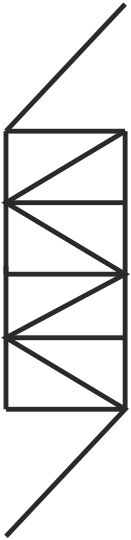

**Solution:**

Since there is a restriction on the rotation of the figure, we will check which of the option figures can exactly fit in the given question figure.

By comparison of all the option figures, only the second option figure is embedded in the given question figure.

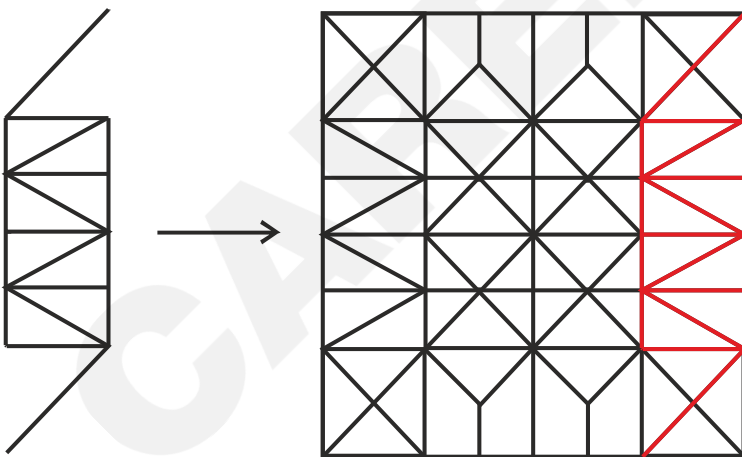

Hence, the **second option** is correct.

- Q. 45** **Directions:** Select the option that is embedded in the given figure. (Rotation is NOT allowed)

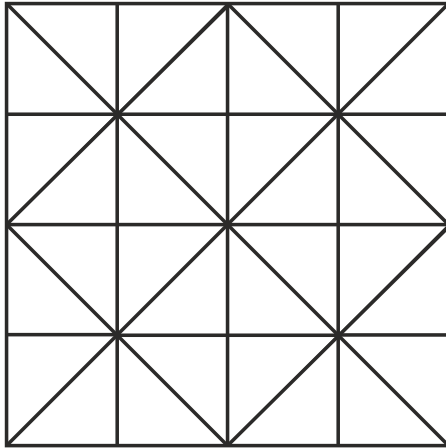

*Option 1:*

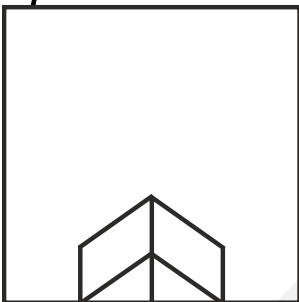

*Option 2:*

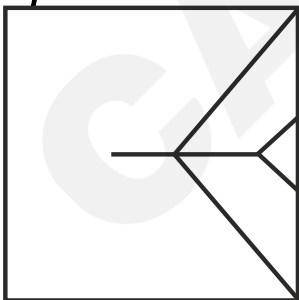

**Option 3:**

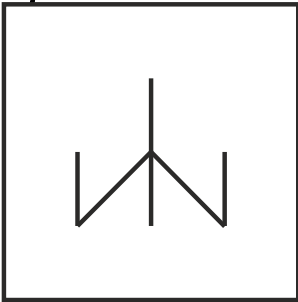

**Option 4:**

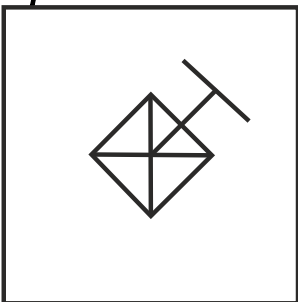

**Correct Answer:**

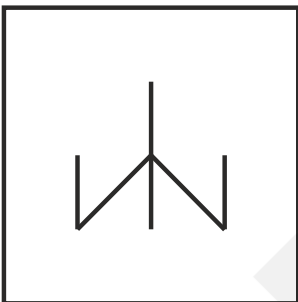

**Solution:**

Since there is a restriction on the rotation of the figure, we will check which of the option figures can exactly fit in the given question figure.

By comparison of all the option figures, only the third option figure is embedded in the given question figure.

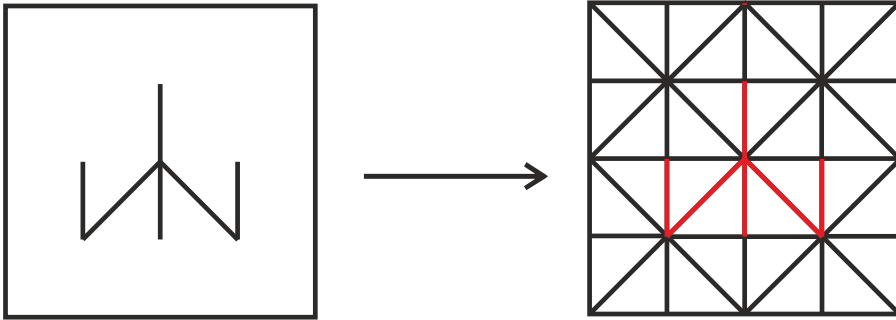

Hence, the **third option** is correct.

- Q. 46** **Directions:** From the given options, select the figure that is embedded in the following figure (rotation is NOT allowed).

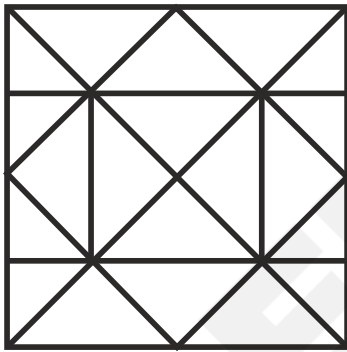

**Option 1:**

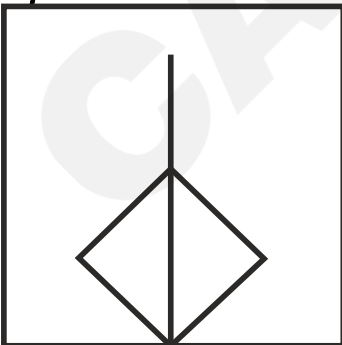

*Option 2:*

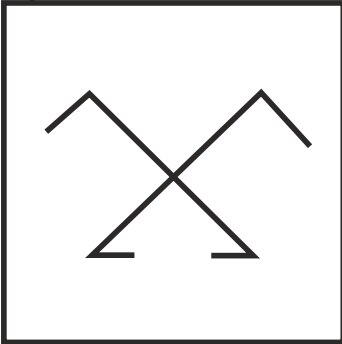

*Option 3:*

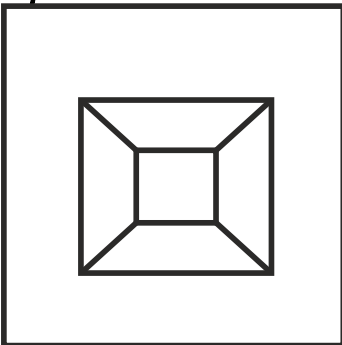

*Option 4:*

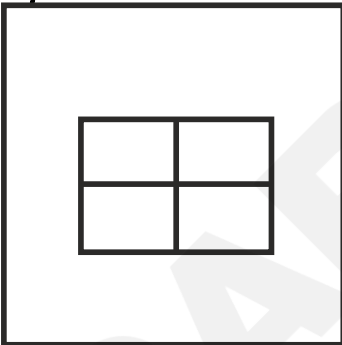

**Correct Answer:**

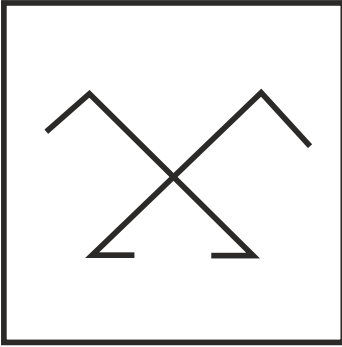

**Solution:**

Since there is a restriction on the rotation of the figure, we will check which of the option figures can exactly fit in the given question figure.

By comparison of all the option figures, only the second option figure is embedded in the given question figure.

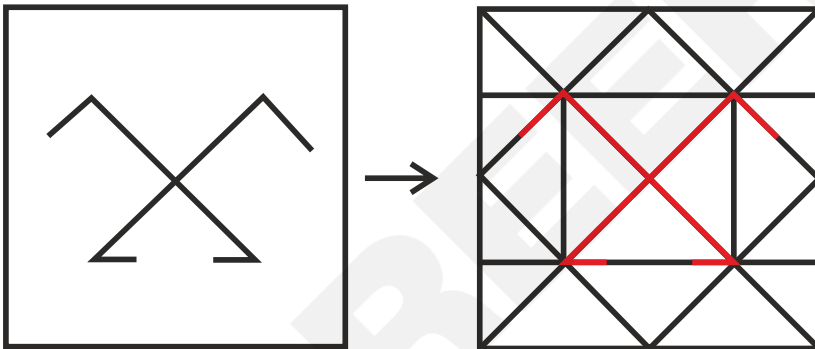

Hence, the **second option** is correct.

- Q. 47** **Directions:** Select the option that is embedded in the given figure (rotation is NOT allowed).

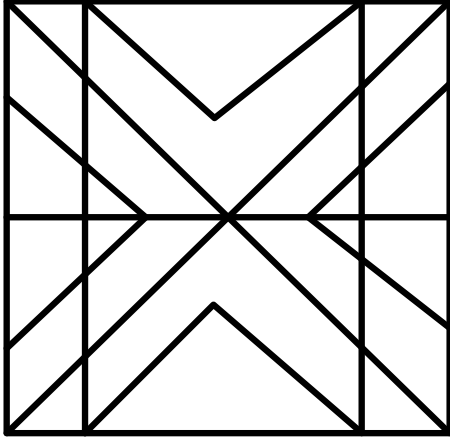

*Option 1:*

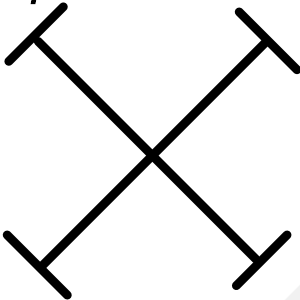

*Option 2:*

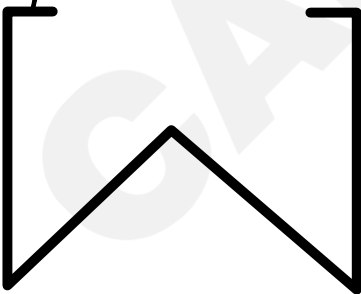

*Option 3:*

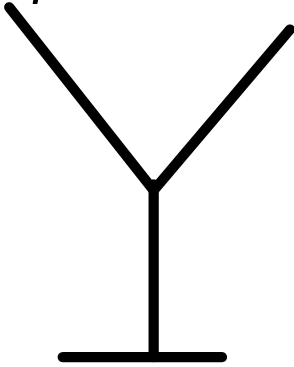

*Option 4:*

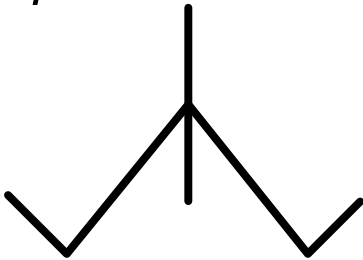

*Correct Answer:*

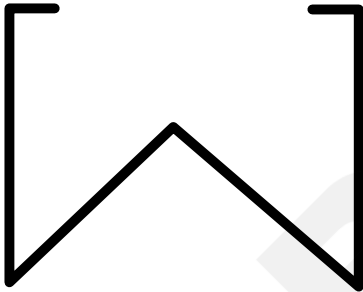

**Solution:**

Since there is a restriction on the rotation of the figure, we will check which of the option figures can exactly fit in the given question figure.

By comparison of all the option figures, only the second option figure is embedded in the given question figure.

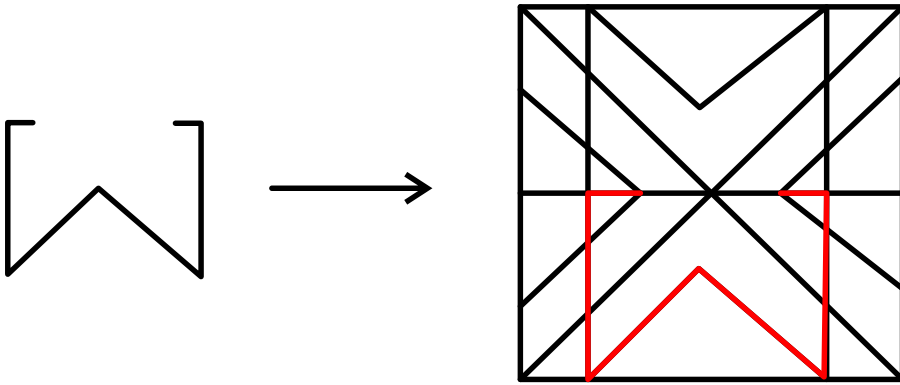

Hence, the **second option** is correct.

- Q. 48** **Directions:** Select the option that is embedded in the given figure (rotation is NOT allowed).

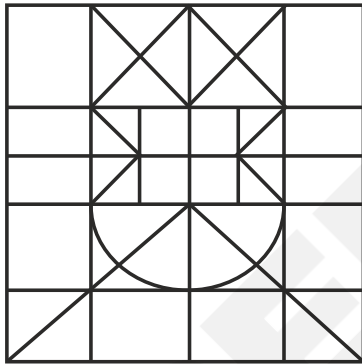

**Option 1:**

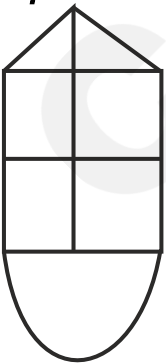

**Option 2:**

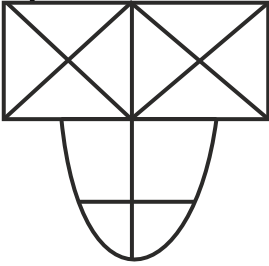

**Option 3:**

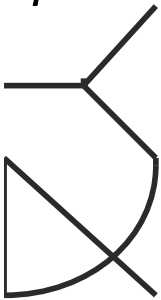

**Option 4:**

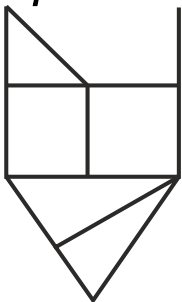

**Correct Answer:**



**Solution:**

Since there is a restriction on the rotation of the figure, we will check which of the option figures can exactly fit in the given question figure.

By comparison of all the option figures, only the third option figure is embedded in the given question figure.

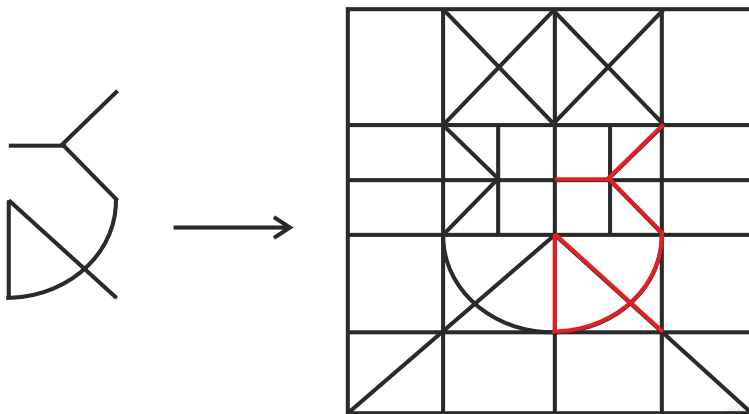

Hence, the **third option** is correct.

- Q. 49** **Directions:** Select the option that is embedded in the given figure (rotation is NOT allowed).

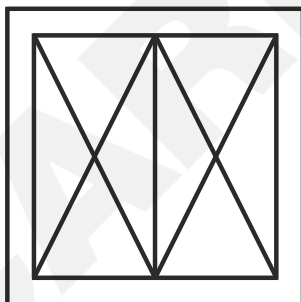

**Option 1:**



*Option 2:*

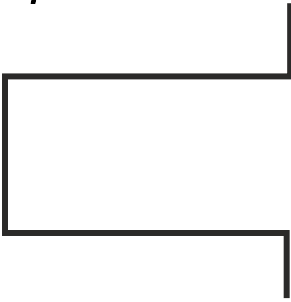

*Option 3:*

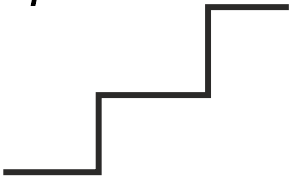

*Option 4:*

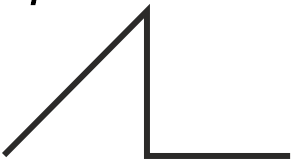

*Correct Answer:*



**Solution:**

Since there is a restriction on the rotation of the figure, we will check which of the option figures can exactly fit in the given question figure.

By comparison of all the option figures, only the first option figure is embedded in the given question figure.

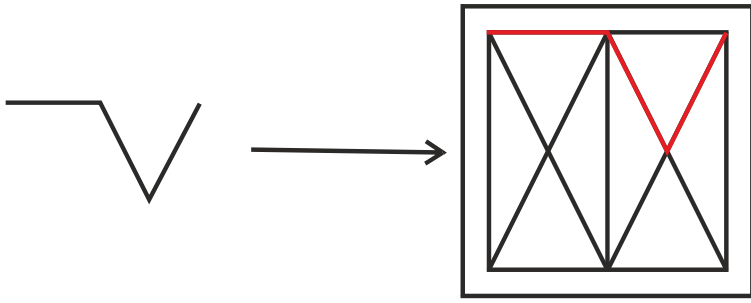

Hence, the **first option** is correct.

**Q. 50** **Directions:** Select the option that is embedded in the given figure (rotation is NOT allowed).

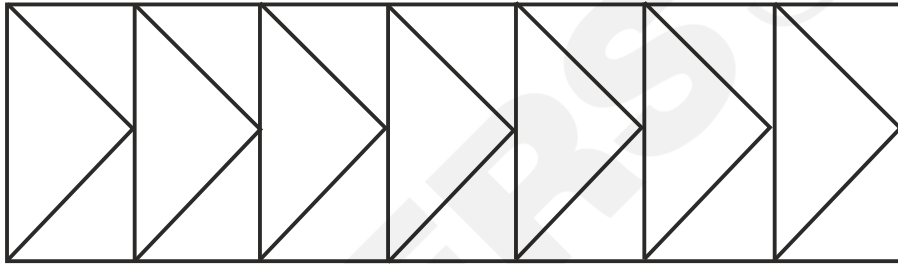

**Option 1:**

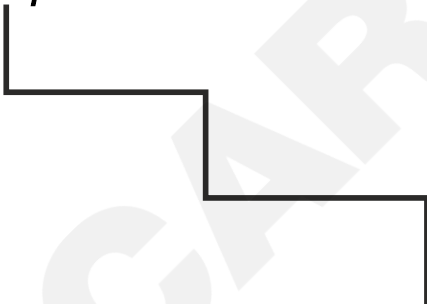

**Option 2:**

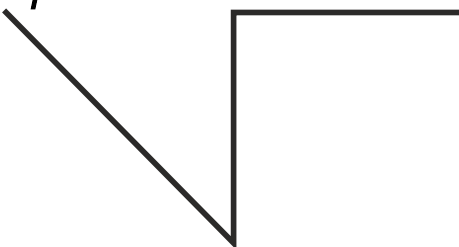

*Option 3:*

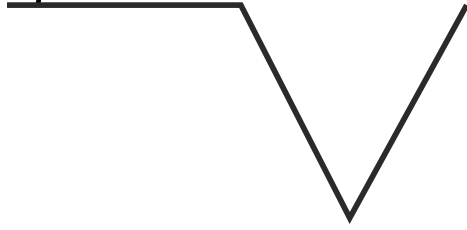

*Option 4:*

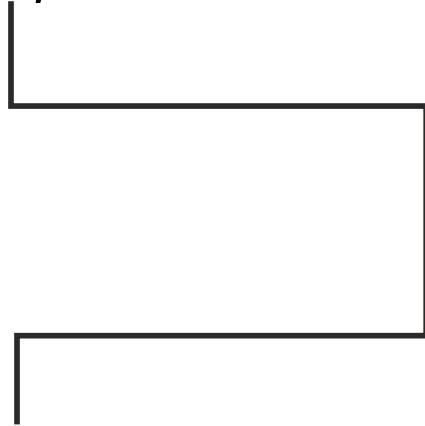

*Correct Answer:*

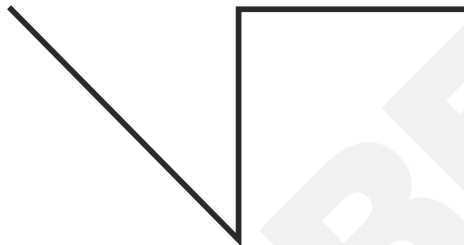

**Solution:**

Since there is a restriction on the rotation of the figure, we will check which of the option figures can exactly fit in the given question figure.

By comparison of all the option figures, only the second option figure is embedded in the given question figure.

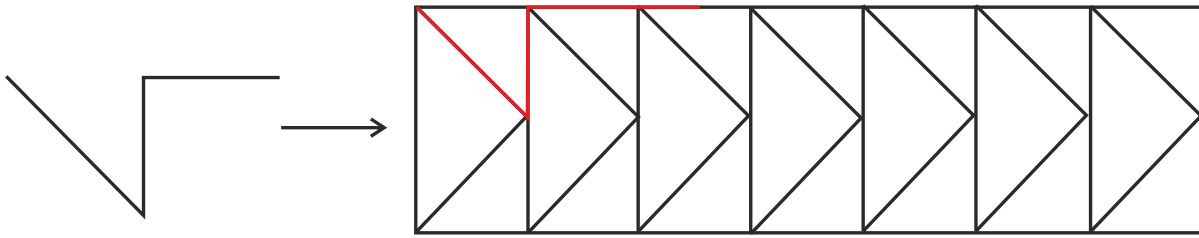

Hence, the **second option** is correct.

- Q. 51** **Directions:** Select the option figure that is embedded in the given figure as its part (rotation is not allowed).

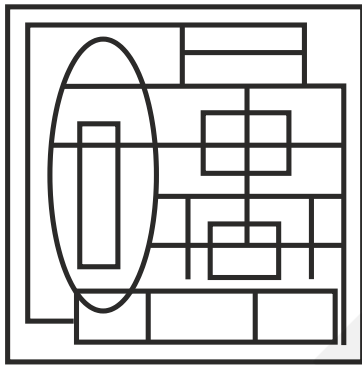

**Option 1:**

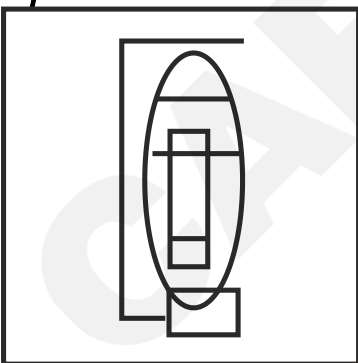

*Option 2:*

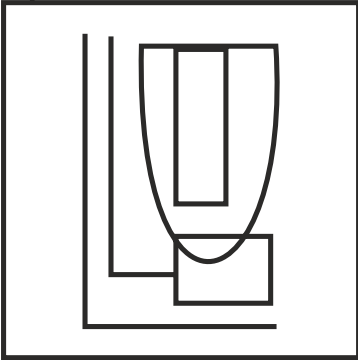

*Option 3:*

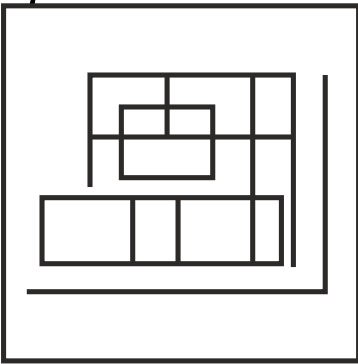

*Option 4:*

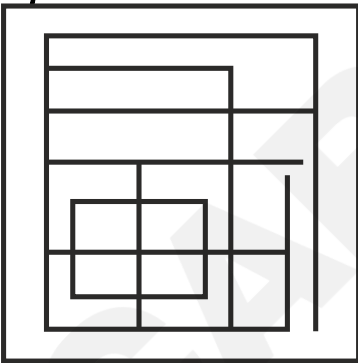

**Correct Answer:**

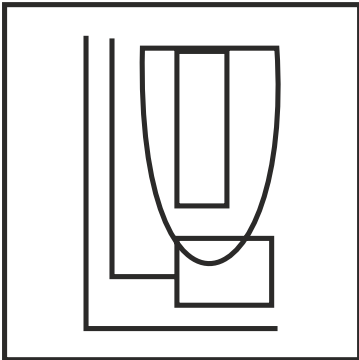

**Solution:**

Since there is a restriction on the rotation of the figure, we will check which of the option figures can exactly fit in the given question figure.

By comparison of all the option figures, only the second option figure is embedded in the given question figure.

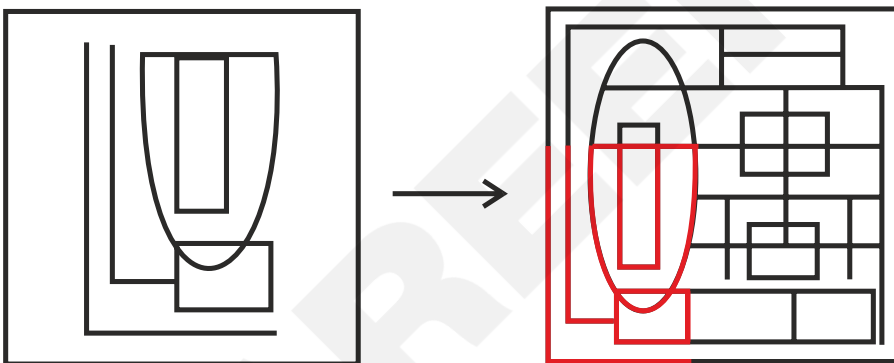

Hence, the **second option** is correct.

- Q. 52** **Directions:** Select the option figure that is embedded in the given figure (rotation is not allowed).

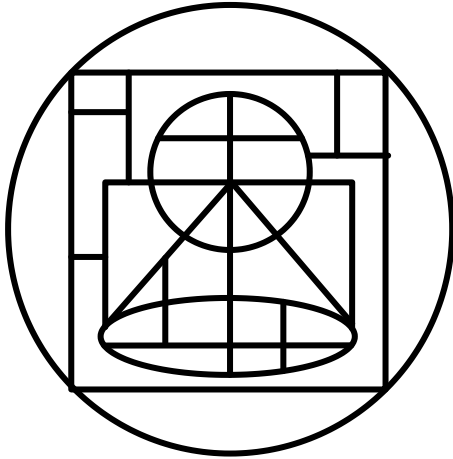

*Option 1:*

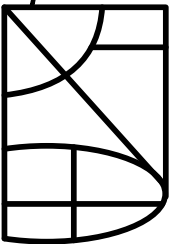

*Option 2:*

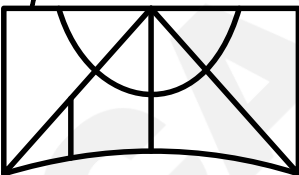

*Option 3:*

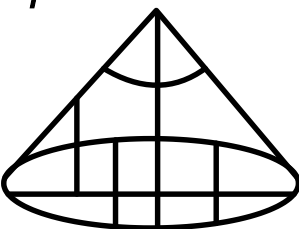

**Option 4:**

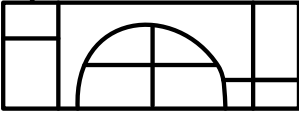

**Correct Answer:**

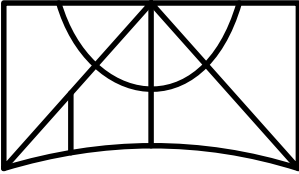

**Solution:**

Since there is a restriction on the rotation of the figure, we will check which of the option figures can exactly fit in the given question figure.

By comparison of all the option figures, only the second option figure is embedded in the given question figure.

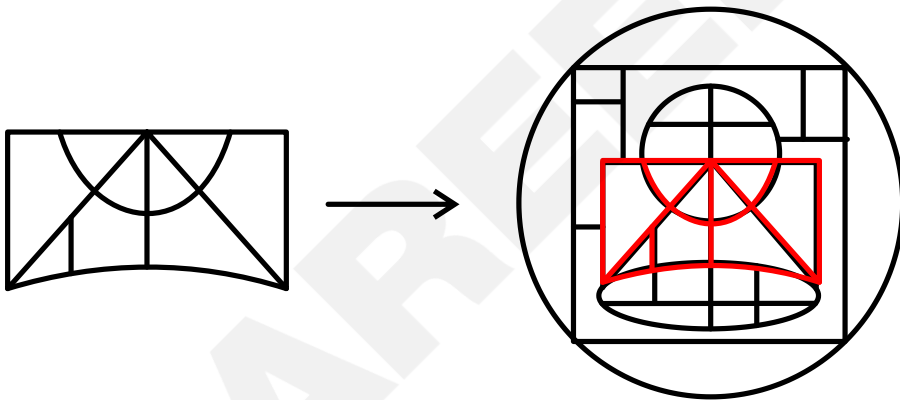

Hence, the **second option** is correct.

**Q. 53** **Directions:** Select the option that is embedded in the given figure as its part (rotation is NOT allowed).

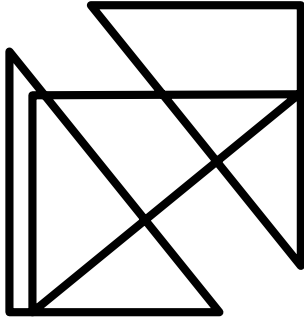

*Option 1:*

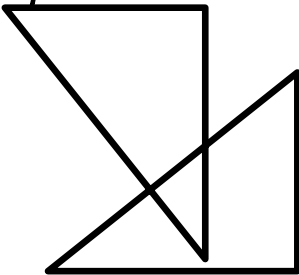

*Option 2:*

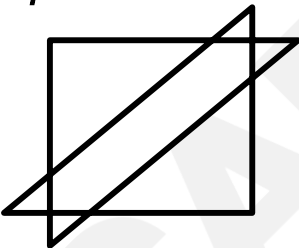

*Option 3:*

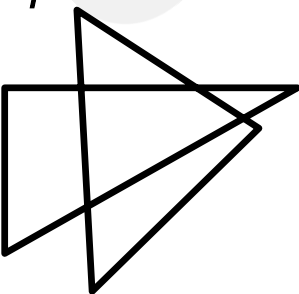

*Option 4:*

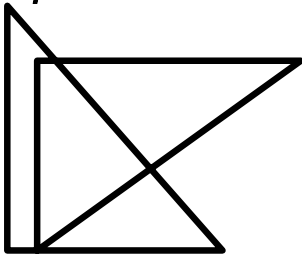

*Correct Answer:*

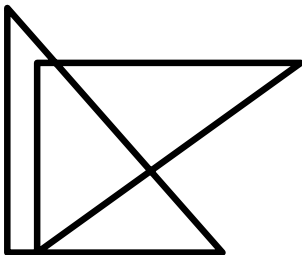

**Solution:**

Since there is a restriction on the rotation of the figure, we will check which of the option figures can exactly fit in the given question figure.

By comparison of all the option figures, only the fourth option figure is embedded in the given question figure.



Hence, the **fourth option** is correct.

- Q. 54** **Directions:** Select the option figure that is embedded in the given figure as its part (rotation is NOT allowed).

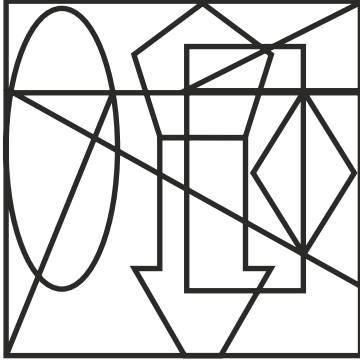

**Option 1:**



**Option 2:**

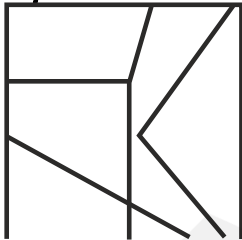

**Option 3:**



**Option 4:**

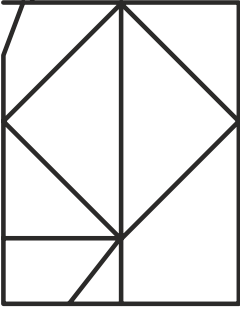

**Correct Answer:**

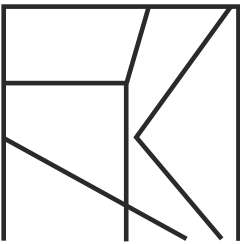

**Solution:**

Since there is a restriction on the rotation of the figure, we will check which of the option figures can exactly fit in the given question figure.

By comparison of all the option figures, only the second option figure is embedded in the given question figure.

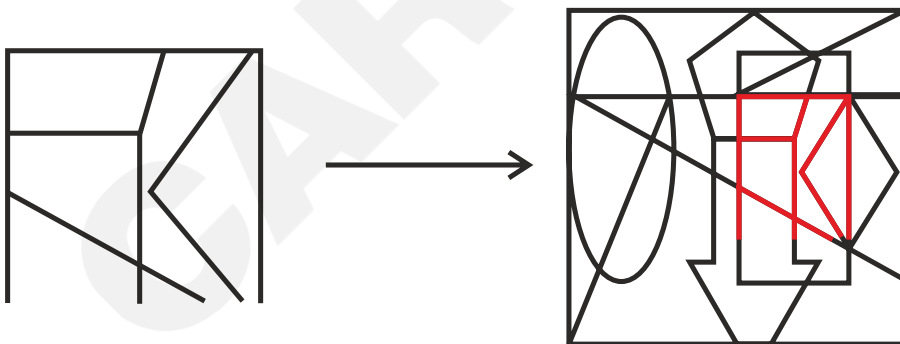

Hence, the **second option** is correct.

- Q. 55** **Directions:** Select the option that is embedded in the given figure as its part (rotation is NOT allowed).

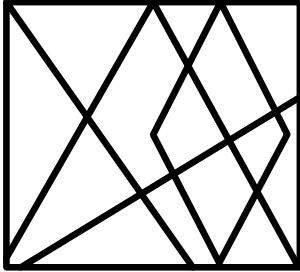

*Option 1:*

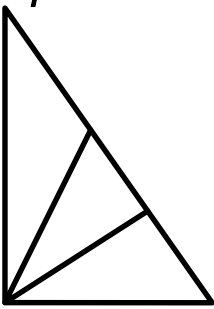

*Option 2:*

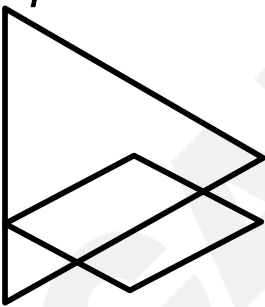

*Option 3:*

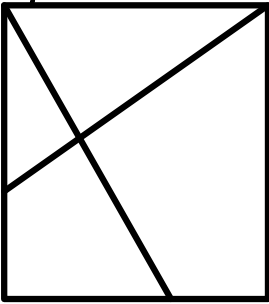

*Option 4:*

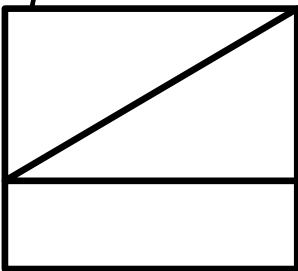

*Correct Answer:*

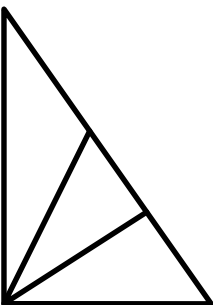

**Solution:**

Since there is a restriction on the rotation of the figure, we will check which of the option figures can exactly fit in the given question figure.

By comparison of all the option figures, only the first option figure is embedded in the given question figure.

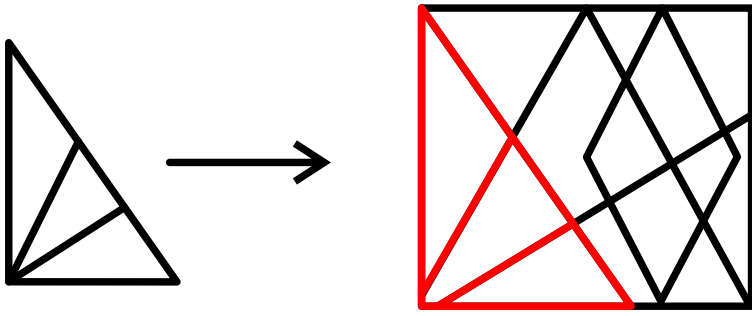

Hence, the **first option** is correct.

- Q. 56** **Directions:** Select the option figure that is embedded in the given figure as its part (rotation is NOT allowed).

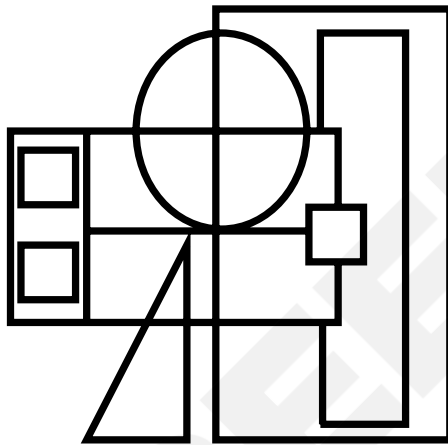

*Option 1:*



*Option 2:*

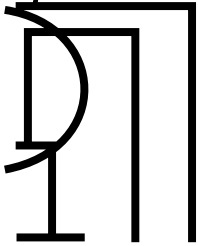

*Option 3:*



*Option 4:*

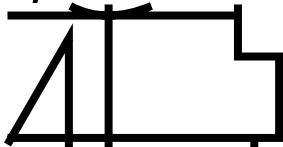

*Correct Answer:*

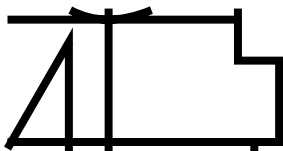

**Solution:**

Since there is a restriction on the rotation of the figure, we will check which of the option figures can exactly fit in the given question figure.

By comparison of all the option figures, only the fourth option figure is embedded in the given question figure.

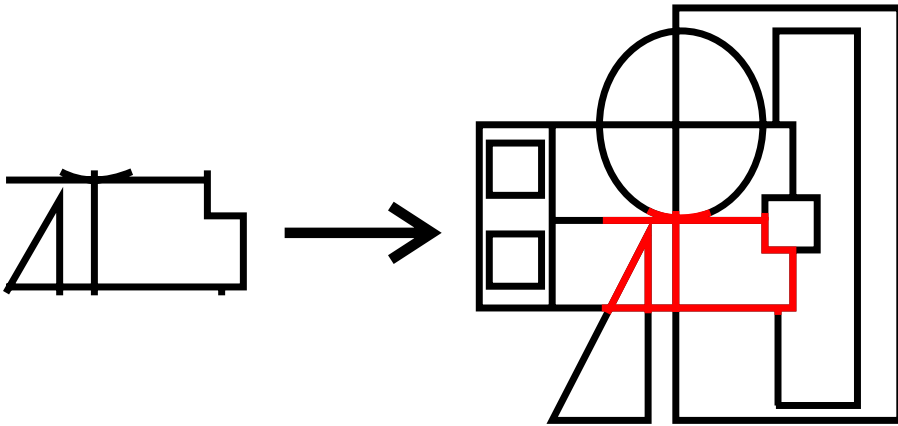

Hence, the **fourth option** is correct.

- Q. 57** **Directions:** Select the option figure that is embedded in the given figure as its part (rotation is NOT allowed).

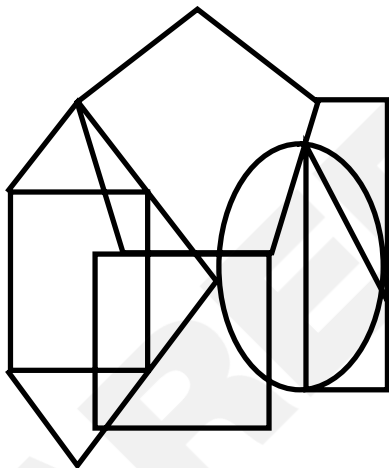

**Option 1:**

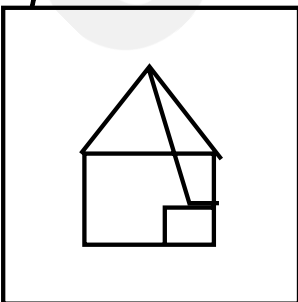

*Option 2:*

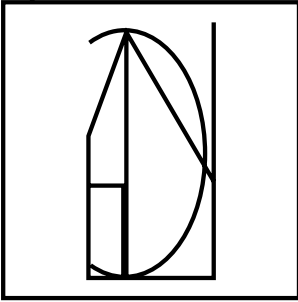

*Option 3:*

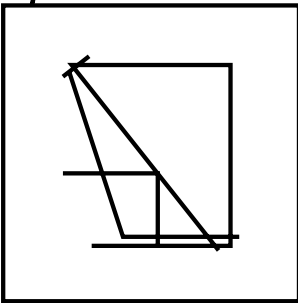

*Option 4:*

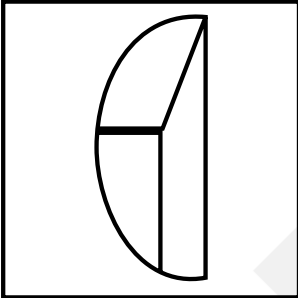

*Correct Answer:*

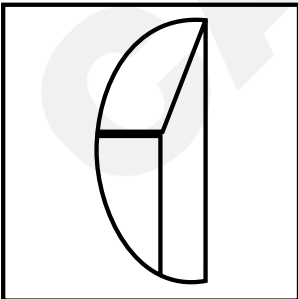

**Solution:**

Since there is a restriction on the rotation of the figure, we will check which of the option figures can exactly fit in the given question figure.

By comparison of all the option figures, only the fourth option figure is embedded in the given question figure.

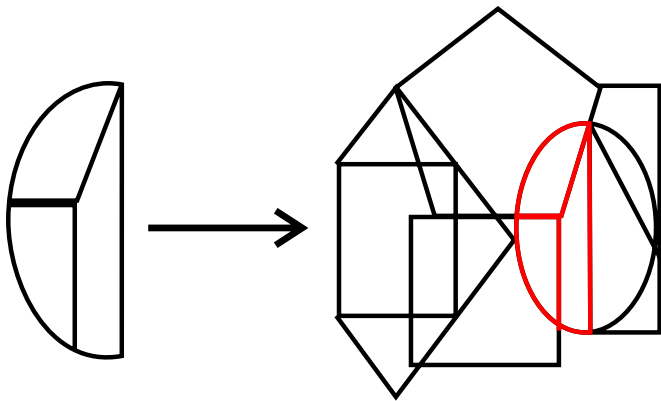

Hence, the **fourth option** is correct.

- Q. 58** **Directions:** Select the option figure that is embedded in the given figure as its part (rotation is NOT allowed).

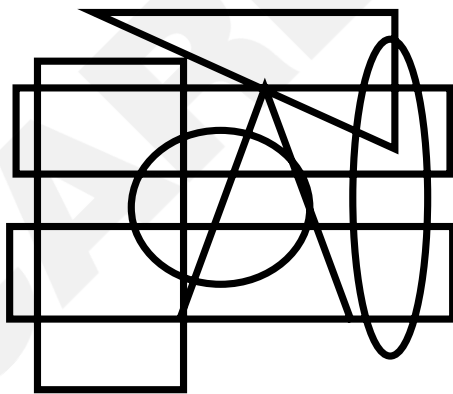

Option 1:

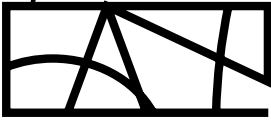

Option 2:

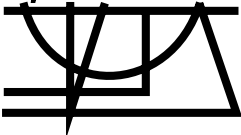

Option 3:

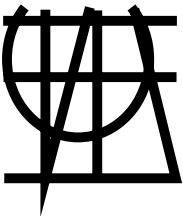

Option 4:

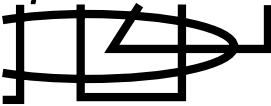

Correct Answer:



### Solution:

Since there is a restriction on the rotation of the figure, we will check which of the option figures can exactly fit in the given question figure.

By comparison of all the option figures, only the first option figure is embedded in the given question figure.

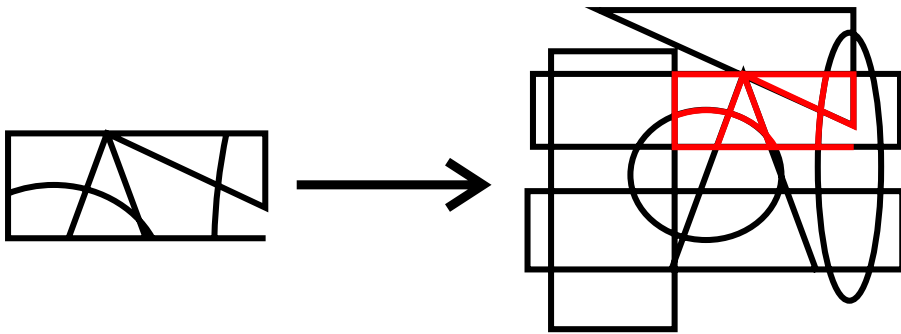

Hence, the **first option** is correct.

- Q. 59** **Directions:** Select the option figure that is embedded in the given figure as its part (rotation is NOT allowed).

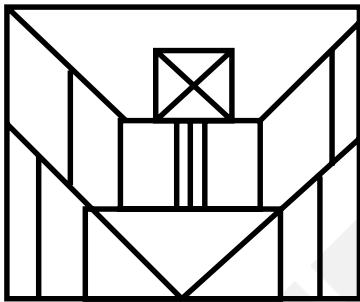

*Option 1:*

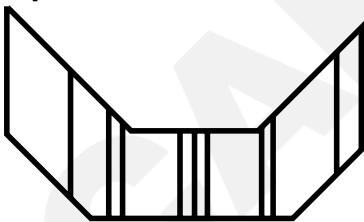

Option 2:

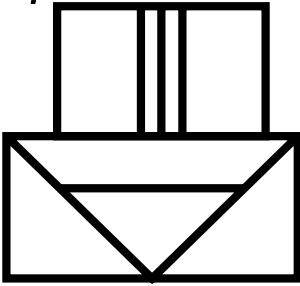

Option 3:

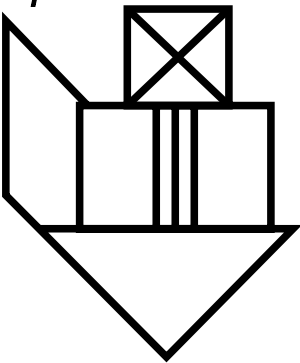

Option 4:

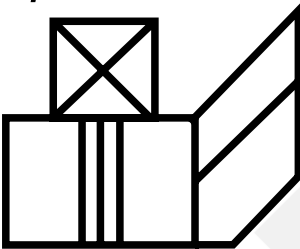

Correct Answer:

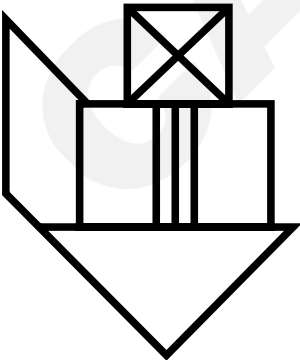

Solution:

Since the figures in the options cannot be rotated, check which of them fits exactly into the figure in the question.

Only the third option fits.

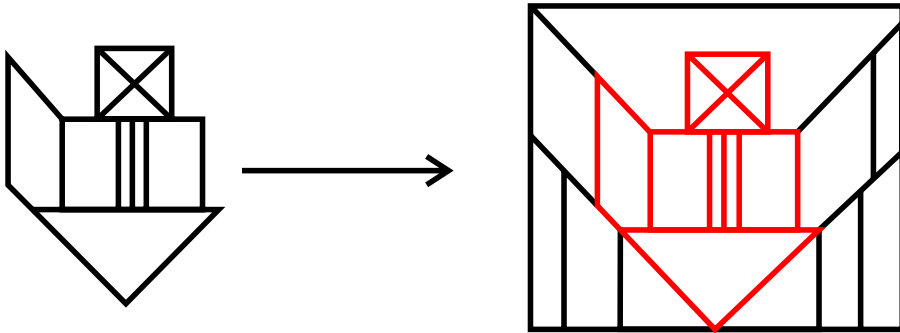

Hence, the **third option** is correct.

- Q. 60** **Directions:** From the given option figures, select the one in which the question figure is embedded.

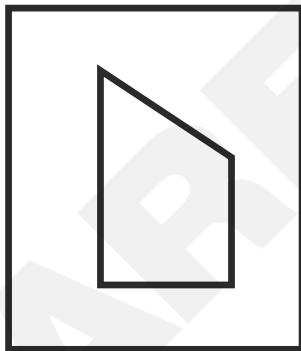

Option 1:

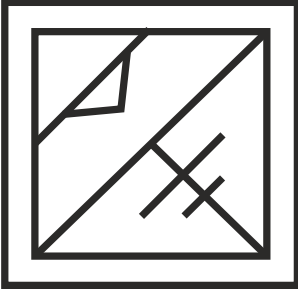

Option 2:

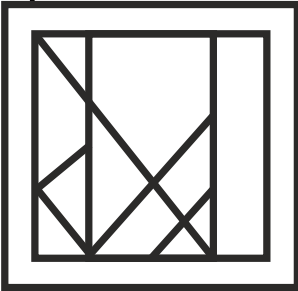

Option 3:

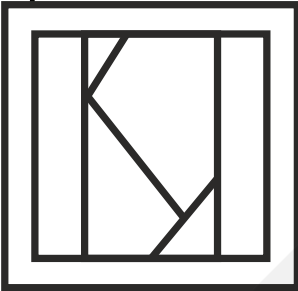

Option 4:



**Correct Answer:**

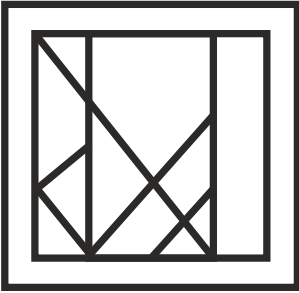

**Solution:**

Since there is no restriction on the rotation of the figure, we will check all possible angles where the question figure can fit itself in all the given option figures.

The question figure is embedded only in the second option figure.

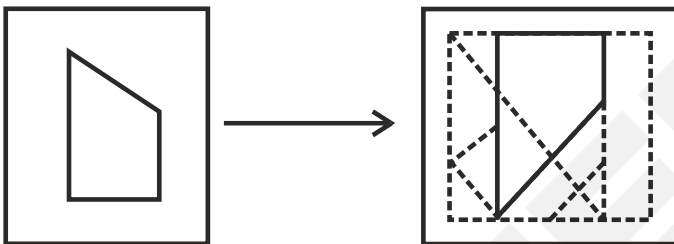

Hence, the **second option** is correct.

**Q. 61** **Directions:** From the given option figures, select the one in which the question figure is embedded.

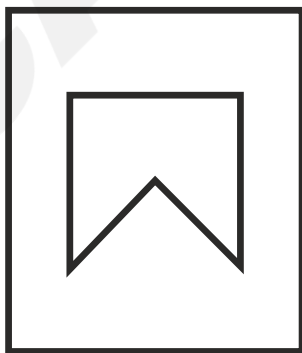

*Option 1:*

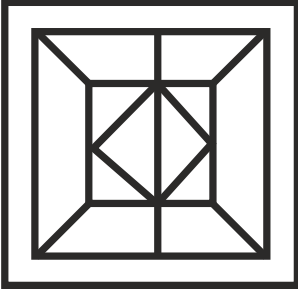

*Option 2:*

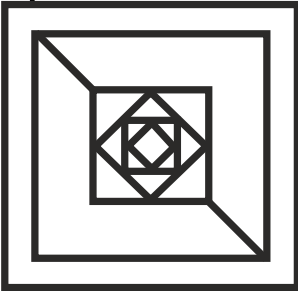

*Option 3:*

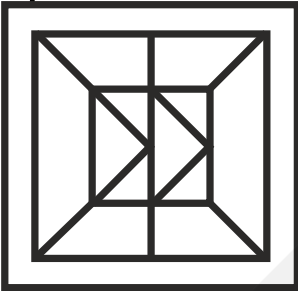

*Option 4:*

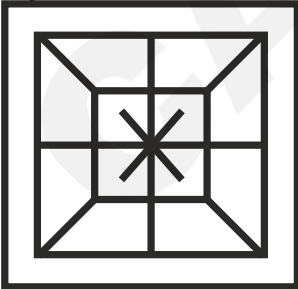

**Correct Answer:**

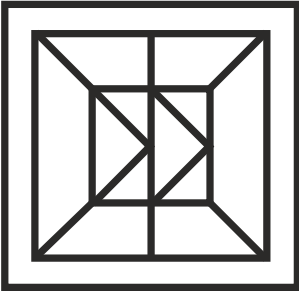

**Solution:**

Since there is no restriction on the rotation of the figure, we will check all possible angles where the question figure can fit itself in all the given option figures.

The given question figure is embedded only in the third option figure.

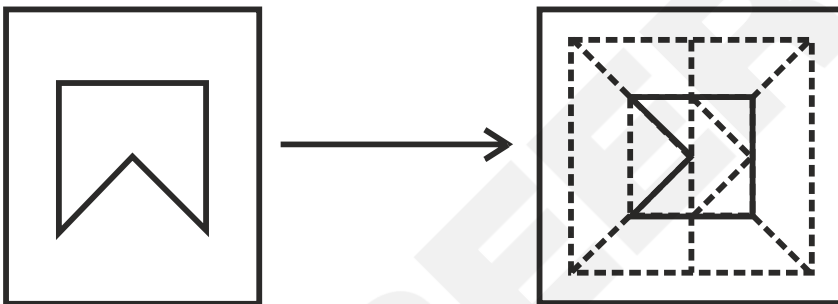

Hence, the **third option** is correct.

- Q. 62** **Directions:** From the given option figures, select the one in which the question figure is embedded.

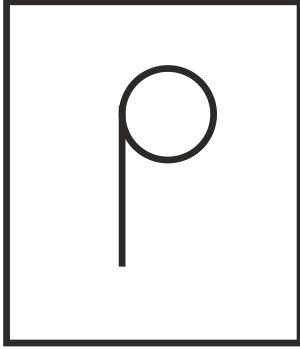

*Option 1:*

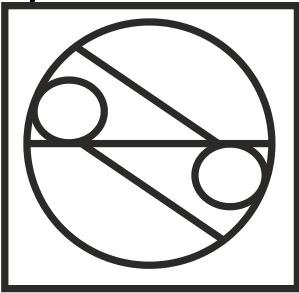

*Option 2:*

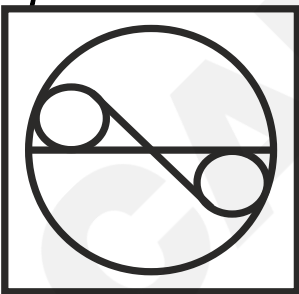

*Option 3:*

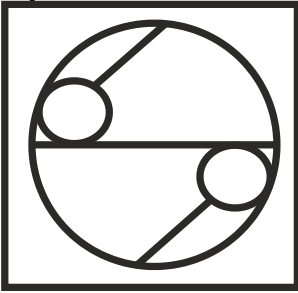

*Option 4:*

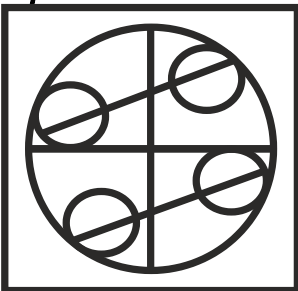

*Correct Answer:*

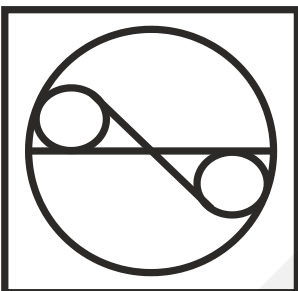

**Solution:**

Since there is no restriction on the rotation of the figure, we will check all possible angles where the question figure can fit itself in all the given option figures.

The question figure is embedded only in the second option figure.

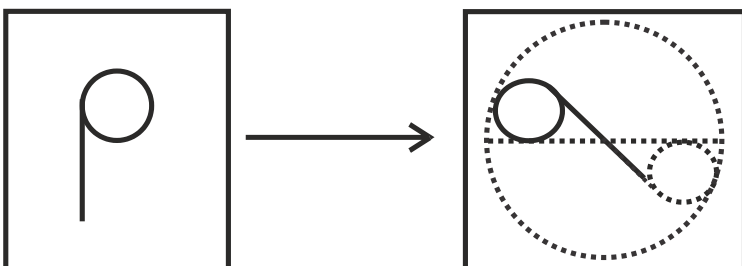

Hence, the **second option** is correct.

- Q. 63** **Directions:** From the given option figures, select the one in which the question figure is embedded.

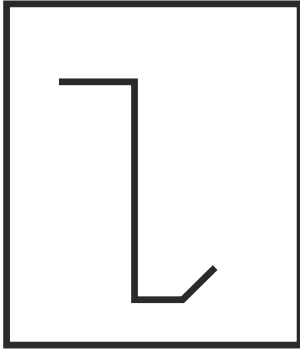

*Option 1:*

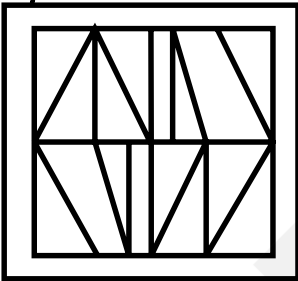

*Option 2:*

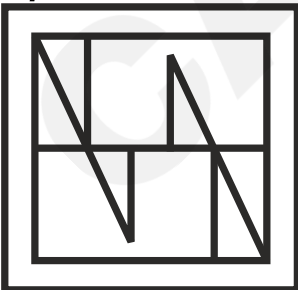

*Option 3:*

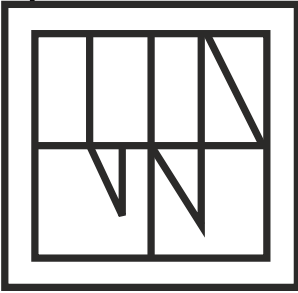

*Option 4:*

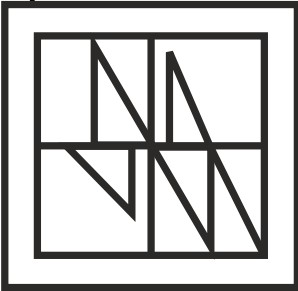

*Correct Answer:*

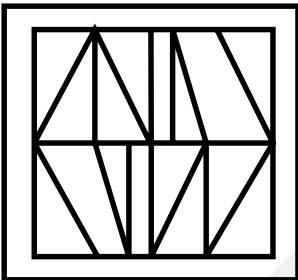

**Solution:**

Since there is no restriction on the rotation of the figure, we will check all possible angles where the question figure can fit itself in all the given option figures.

The question figure is embedded only in the first option figure.

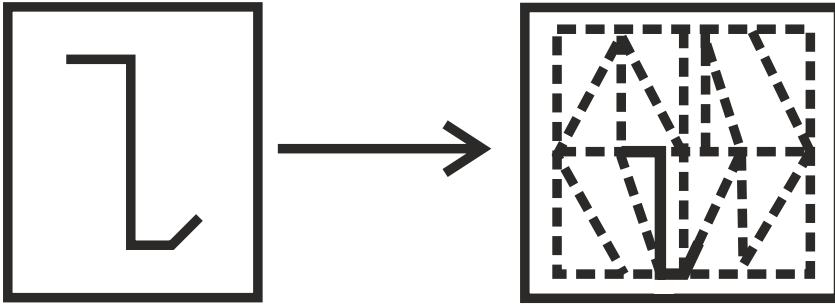

Hence, the **first option** is correct.

- Q. 64** **Directions:** From the given option figures, select the one in which the question figure is embedded.

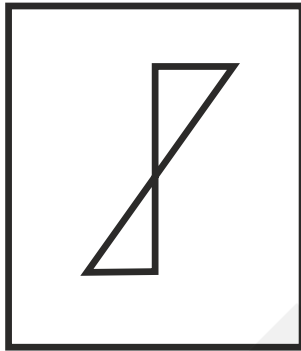

**Option 1:**

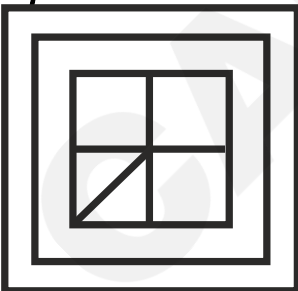

*Option 2:*

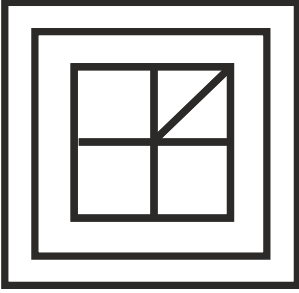

*Option 3:*

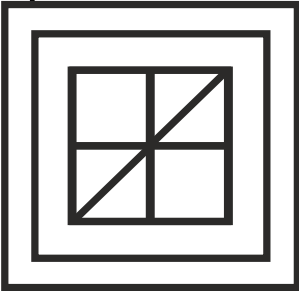

*Option 4:*

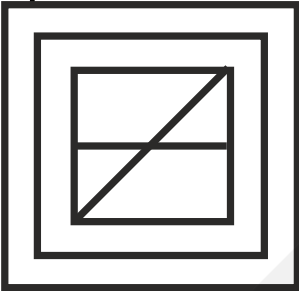

*Correct Answer:*

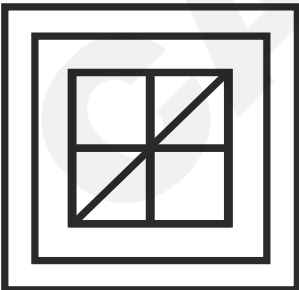

**Solution:**

Since there is no restriction on the rotation of the figure, we will check all possible angles where the question figure can fit itself in all the given option figures.

The question figure is embedded only in the third option figure.

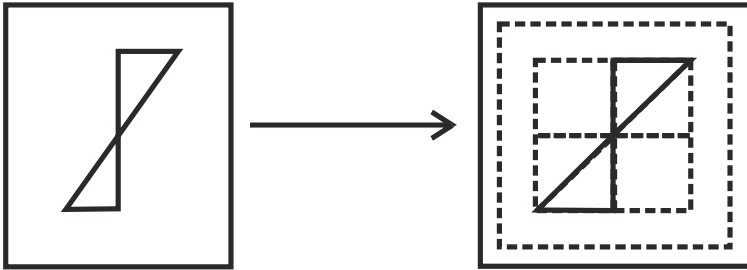

Hence, the **third option** is correct.

- Q. 65** **Directions:** From the given option figures, select the one in which the question figure is embedded.

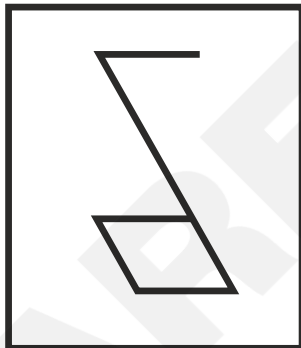

*Option 1:*



Option 2:

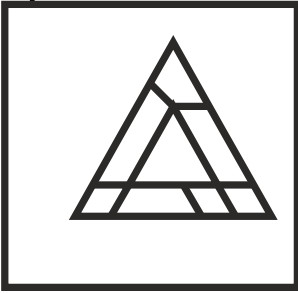

Option 3:

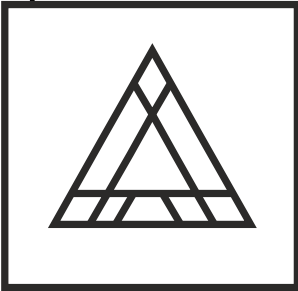

Option 4:

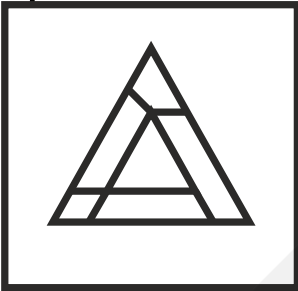

Correct Answer:

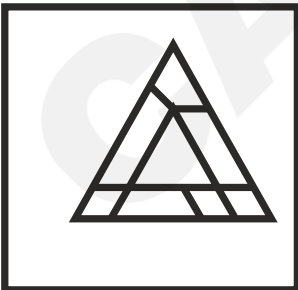

Solution:

Since there is no restriction on the rotation of the figure, we will check all possible angles where the question figure can fit itself in all the given option figures.

The question figure is embedded only in the second option figure.

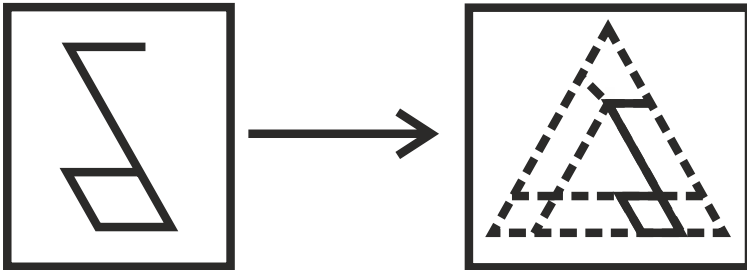

Hence, the **second option** is correct.

- Q. 66** **Directions:** From the given option figures, select the one in which the question figure is embedded.

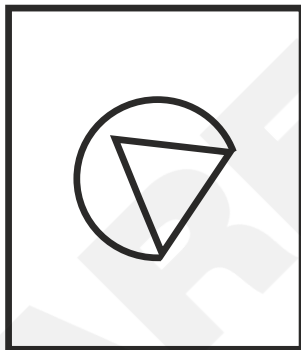

*Option 1:*



*Option 2:*

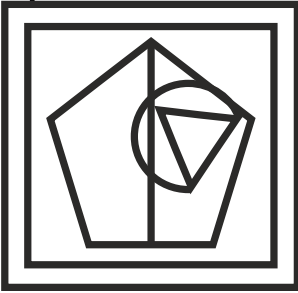

*Option 3:*

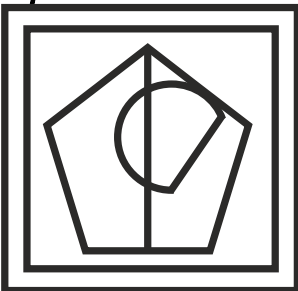

*Option 4:*

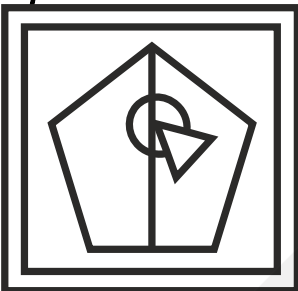

*Correct Answer:*



**Solution:**

As there is no restriction on the rotation of the figure, we will check all the possible angles where the question figure can fit itself in all the given option figures.

As per the observation, the question figure is embedded only in the second option figure.

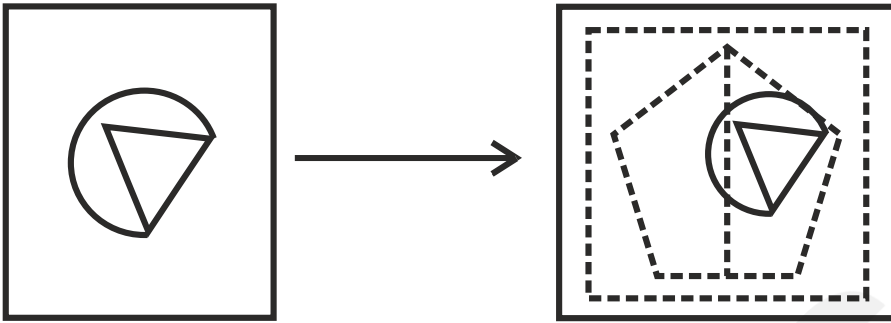

Hence, the **second option** is correct.

- 
- Q. 67** **Directions:** From the given option figures, select the one in which the question figure is embedded.



*Option 1:*

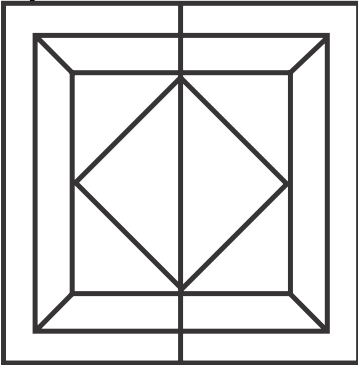

*Option 2:*

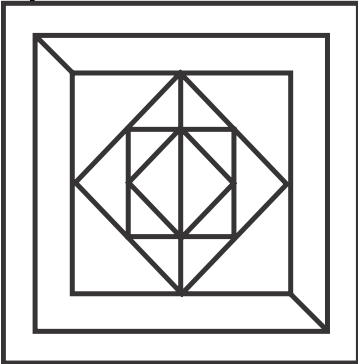

*Option 3:*

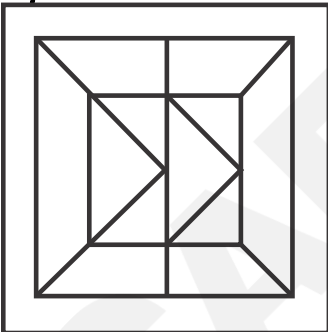

**Option 4:**

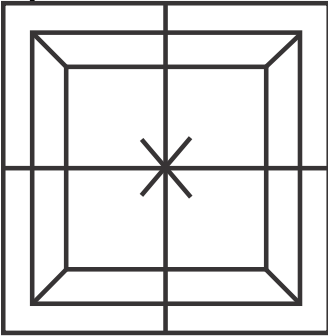

**Correct Answer:**

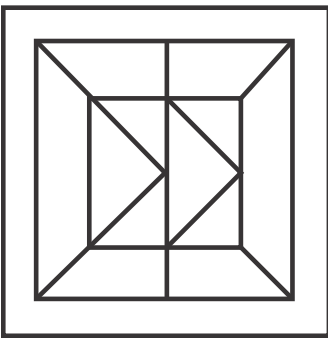

**Solution:**

As there is no restriction on the rotation of the figure, we will check all possible angles where the question figure can fit itself in all the given option figures.

The question figure is embedded only in the third option figure.

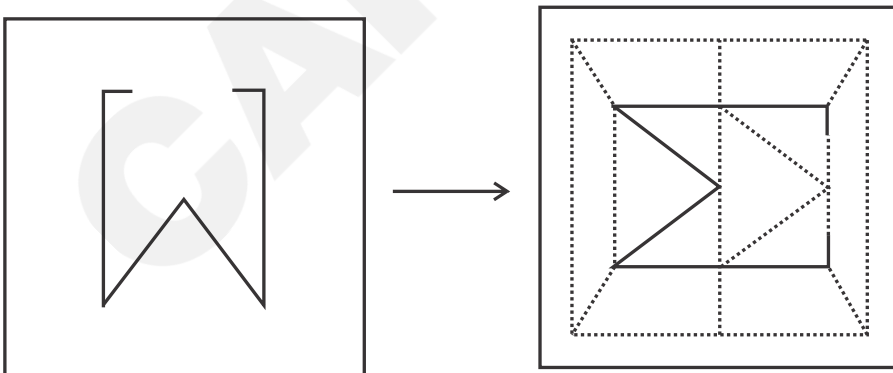

Hence, the **third option** is correct.

- Q. 68** **Directions:** From the given option figures, select the one in which the question figure is embedded.



*Option 1:*

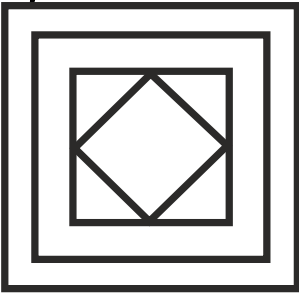

*Option 2:*

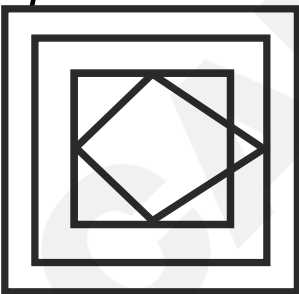

*Option 3:*

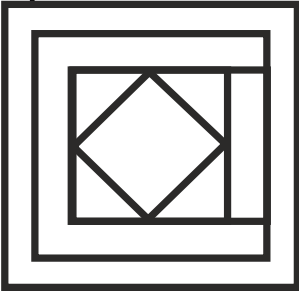

*Option 4:*

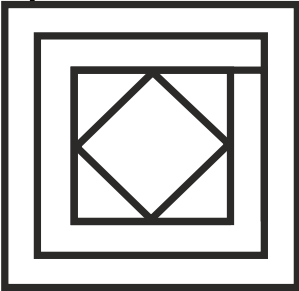

*Correct Answer:*

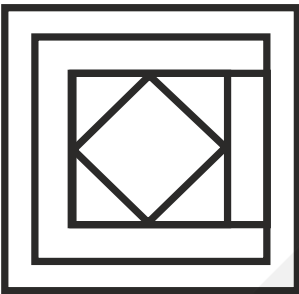

**Solution:**

As there is no restriction on the rotation of the figure, we will check all possible angles where the question figure can fit itself in all the given option figures.

The question figure is embedded only in the third option figure.

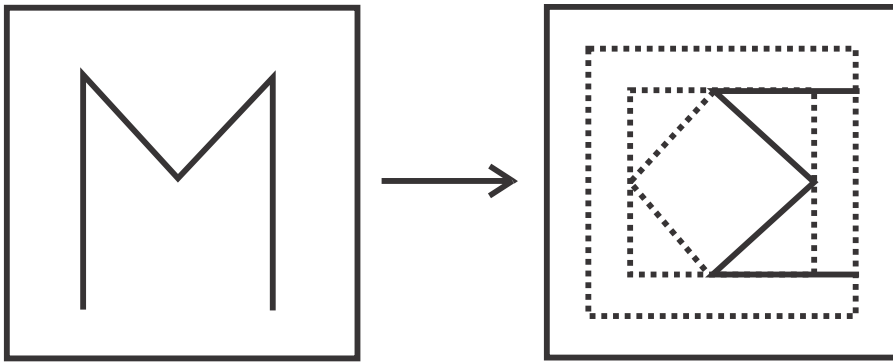

Hence, the **third option** is correct.

- Q. 69** **Directions:** From the given option figures, select the one in which the question figure is embedded.

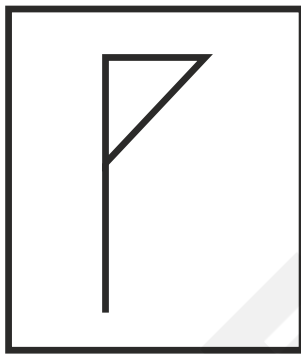

*Option 1:*

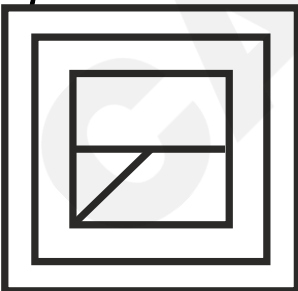

*Option 2:*

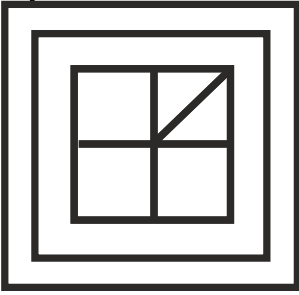

*Option 3:*

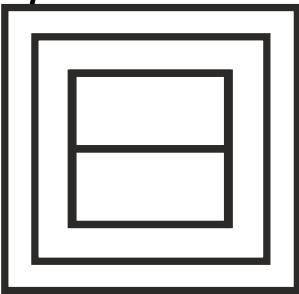

*Option 4:*

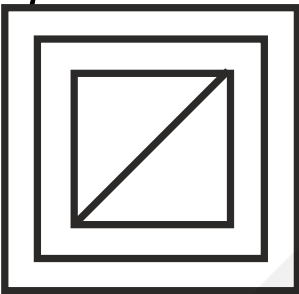

*Correct Answer:*

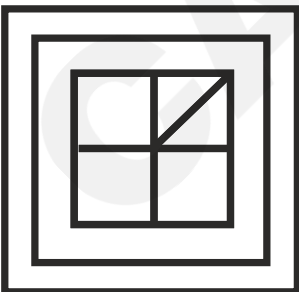

**Solution:**

As there is no restriction on the rotation of the figure, we will check all possible angles where the question figure can fit itself in all the given option figures.

The question figure is embedded only in the second option figure.

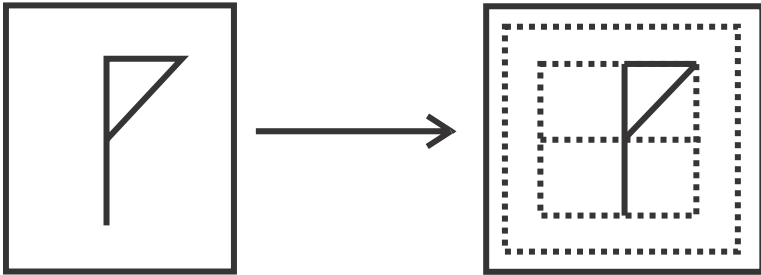

Hence, the **second option** is correct.

- Q. 70** **Directions:** From the given option figures, select the one in which the question figure is embedded.

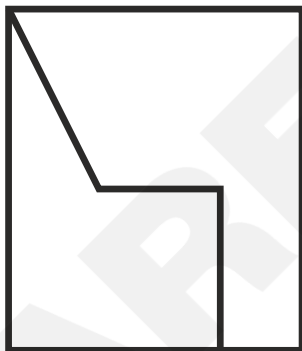

**Option 1:**

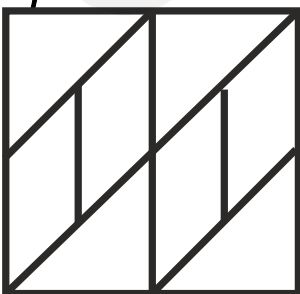

*Option 2:*

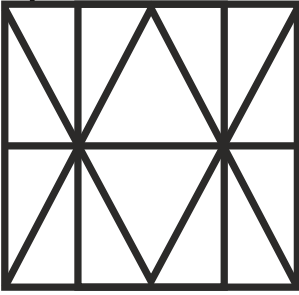

*Option 3:*

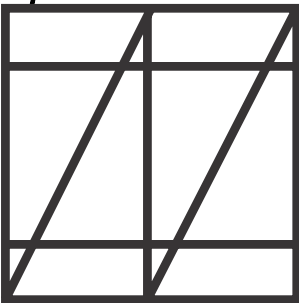

*Option 4:*

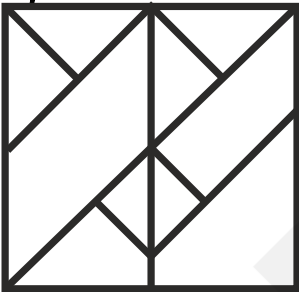

*Correct Answer:*

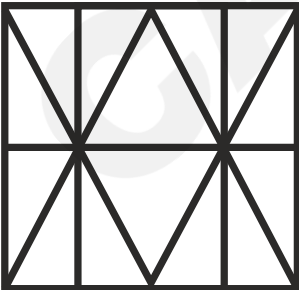

**Solution:**

As there is no restriction on the rotation of the figure, we will check all possible angles where the question figure can fit itself in the given option figures.

The question figure is embedded only in the second option figure.

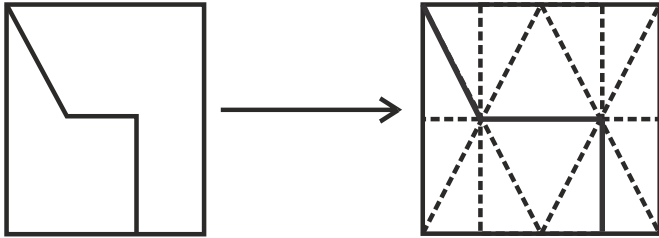

Hence, the **second option** is correct.

- Q. 71** **Directions:** From the given option figures, select the one in which the question figure is embedded.

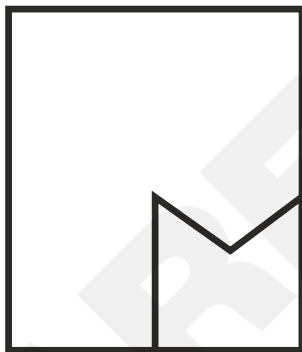

**Option 1:**

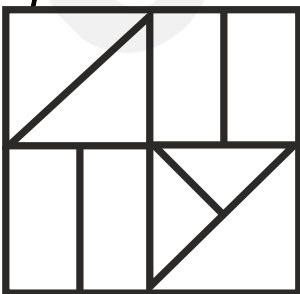

*Option 2:*

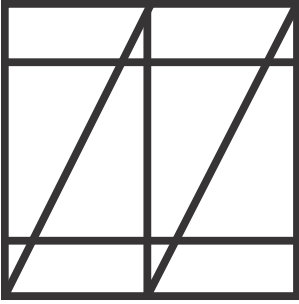

*Option 3:*



*Option 4:*

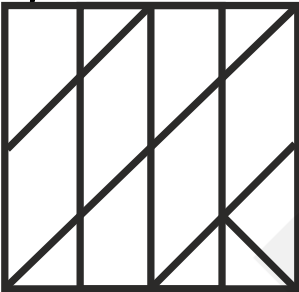

*Correct Answer:*

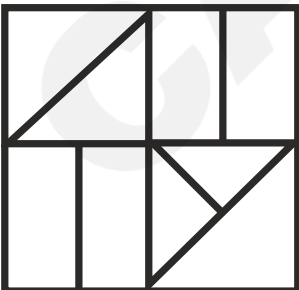

**Solution:**

As there is no restriction on the rotation of the figure, we will check all possible angles where the question figure can fit itself in the given option figures.

The question figure is embedded only in the first option figure.

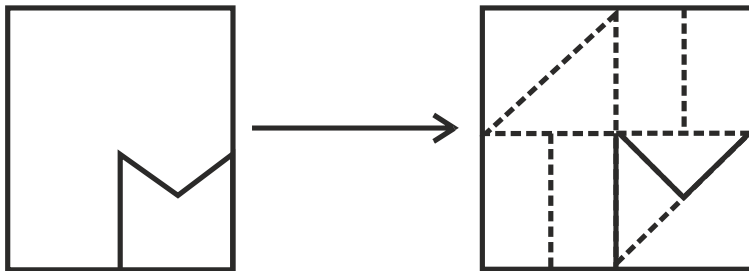

Hence, the **first option** is correct.

- 
- Q. 72** **Directions:** From the given option figures, select the one in which the question figure is embedded.



*Option 1:*

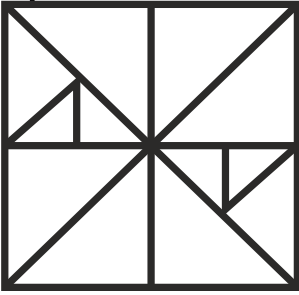

*Option 2:*

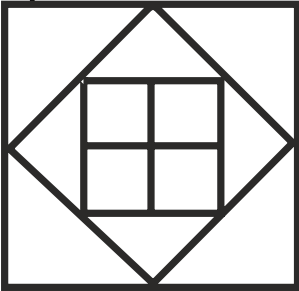

*Option 3:*

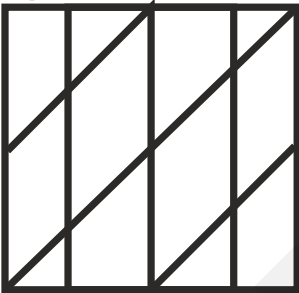

*Option 4:*

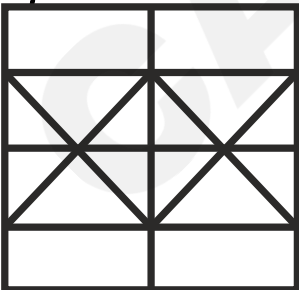

**Correct Answer:**

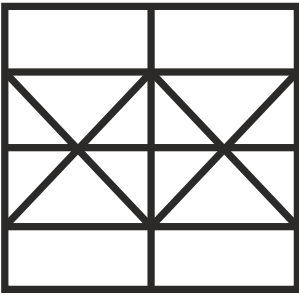

**Solution:**

As there is no restriction on the rotation of the figure, we will check all possible angles where the question figure can fit itself in all the given option figures.

The question figure is embedded only in the fourth option figure.

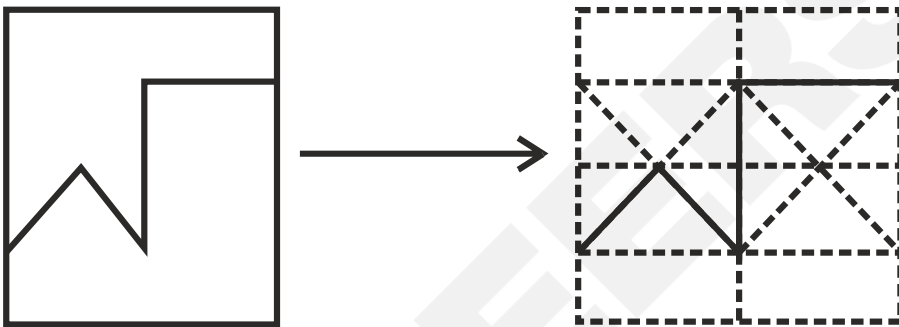

Hence, the **fourth option** is correct.

- Q. 73** **Directions:** From the given option figures, select the one in which the question figure is embedded.

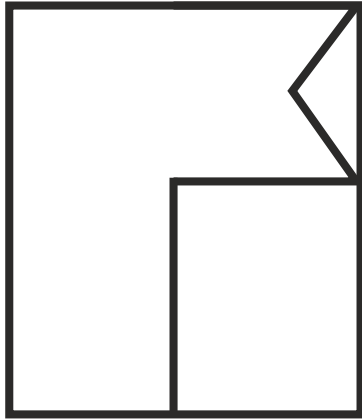

*Option 1:*

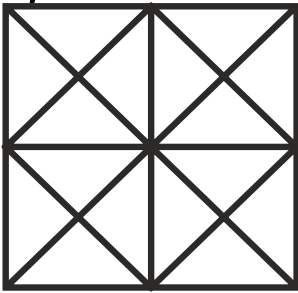

*Option 2:*

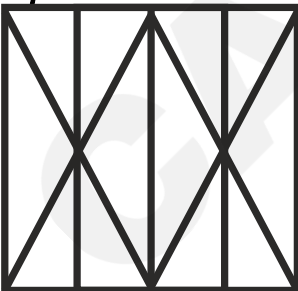

*Option 3:*

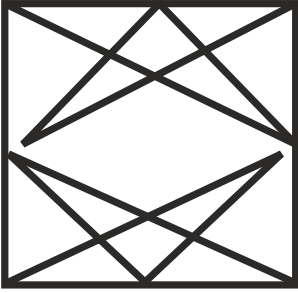

*Option 4:*

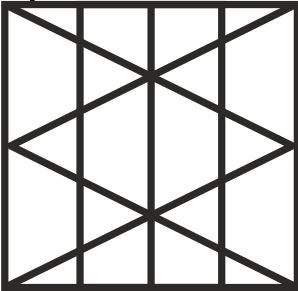

*Correct Answer:*

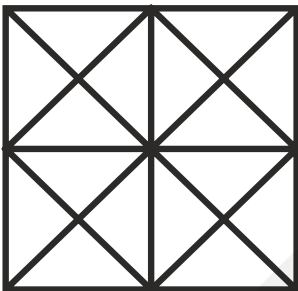

**Solution:**

As there is no restriction on the rotation of the figure, we will check all possible angles where the question figure can fit itself in all the given option figures.

The question figure is embedded only in the first option figure.

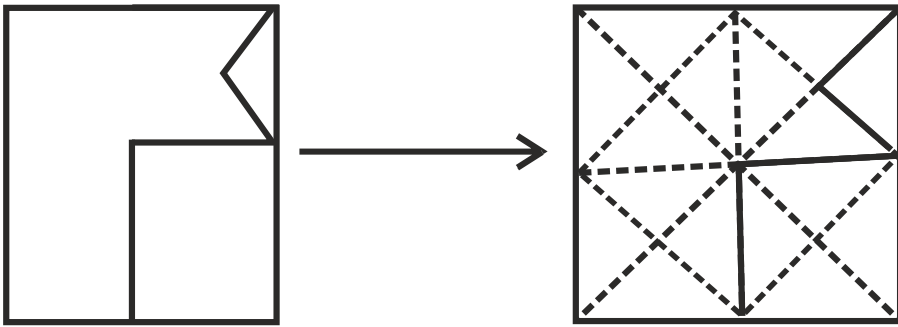

Hence, the **first option** is correct.

- Q. 74** **Directions:** From the given option figures, select the one in which the question figure is embedded.

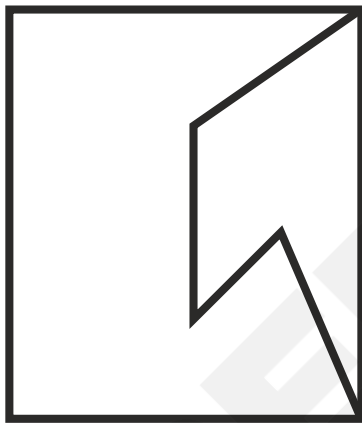

*Option 1:*

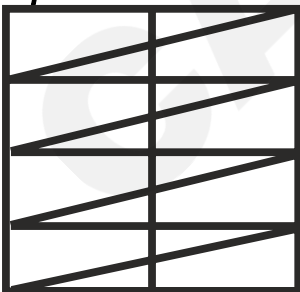

*Option 2:*

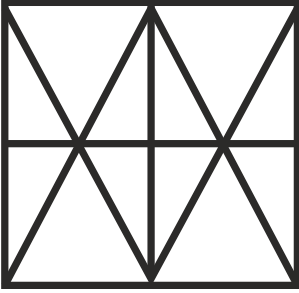

*Option 3:*

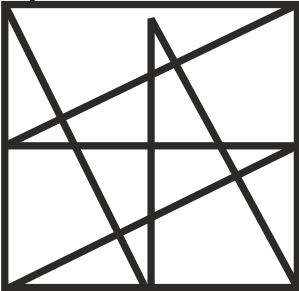

*Option 4:*

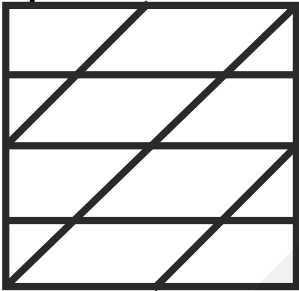

*Correct Answer:*

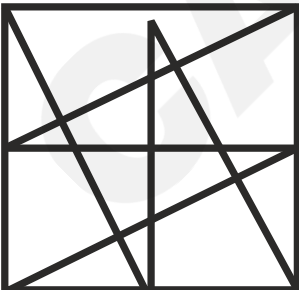

**Solution:**

As there is no restriction on the rotation of the figure, we will check all possible angles where the question figure can fit itself in all the given option figures.

The question figure is embedded only in the third option figure.

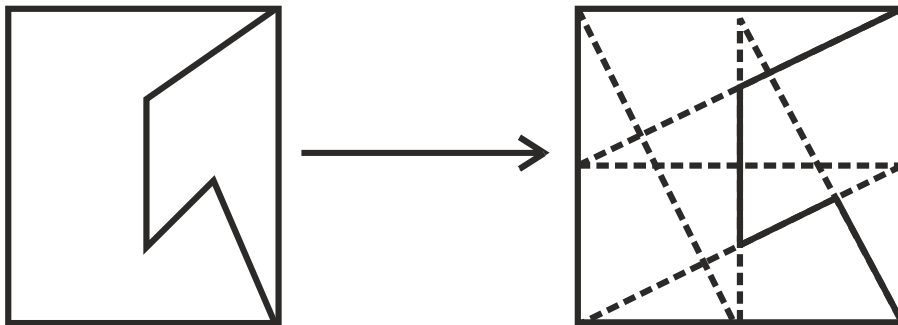

Hence, the **third option** is correct.

- Q. 75** **Directions:** From the given option figures, select the one in which the question figure is embedded.

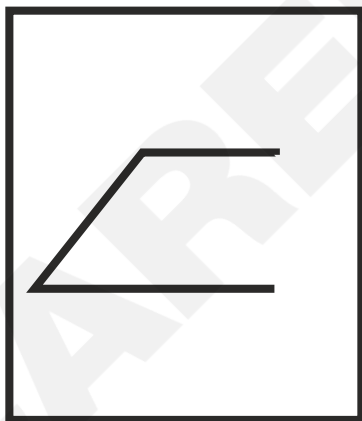

*Option 1:*

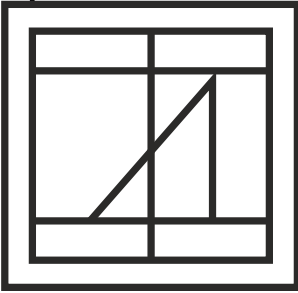

*Option 2:*

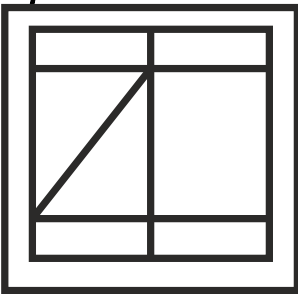

*Option 3:*

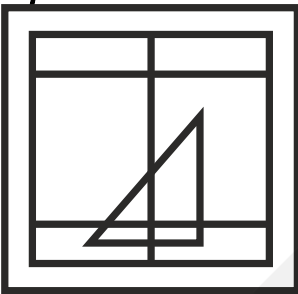

*Option 4:*

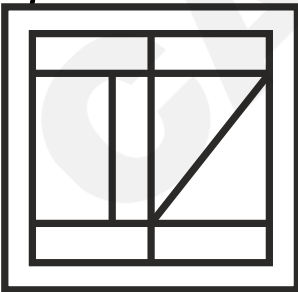

**Correct Answer:**

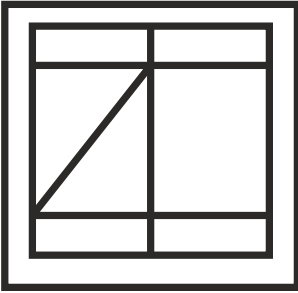

**Solution:**

As there is no restriction on the rotation of the figure, we will check all possible angles where the question figure can fit itself in the given option figures.

The question figure is embedded only in the second option figure.

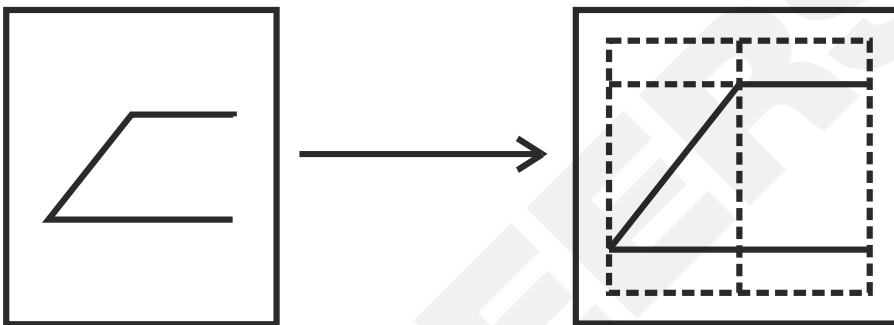

Hence, the **second option** is correct.

**Q. 76** **Directions:** From the given answer figures, select the one in which the question figure is hidden/embedded.

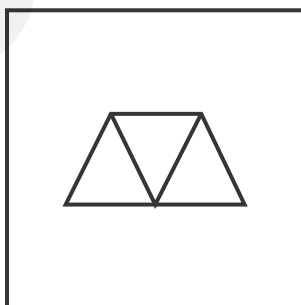

**Option 1:**

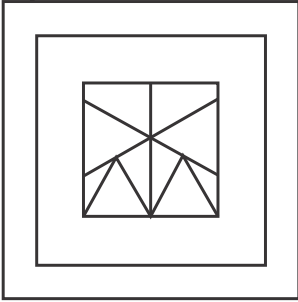

**Option 2:**

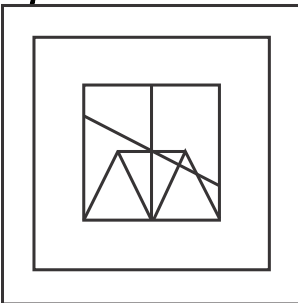

**Option 3:**

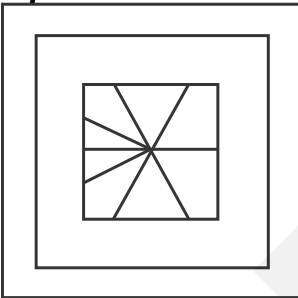

**Option 4:**

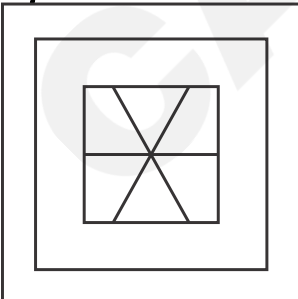

**Correct Answer:**

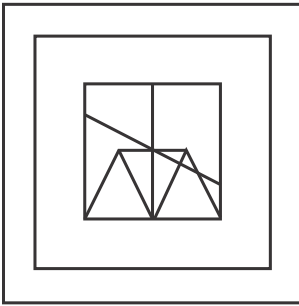

**Solution:**

By comparison of all the option figures, only the second option figure is embedded in the given question figure.

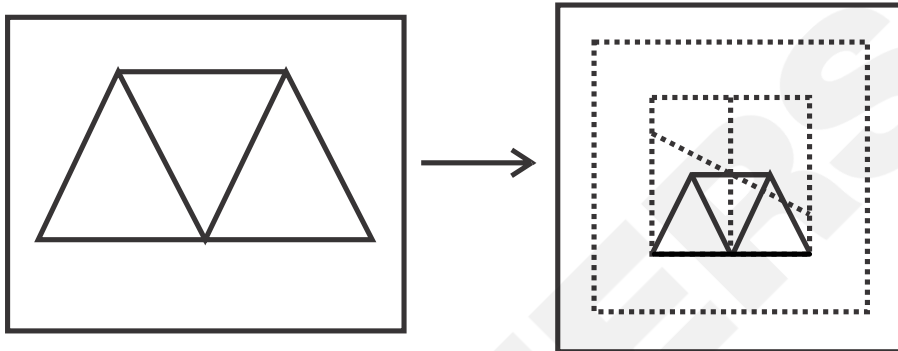

Hence, the **second option** is correct.

**Q. 77** **Directions:** From the given answer figures, select the one in which the question figure is hidden/embedded.



*Option 1:*

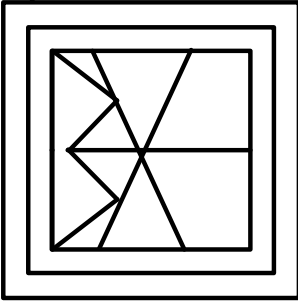

*Option 2:*

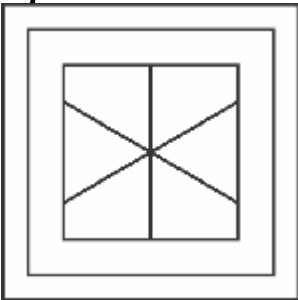

*Option 3:*



*Option 4:*



**Correct Answer:**

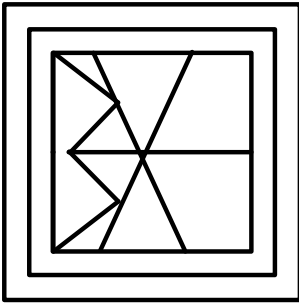

**Solution:**

Because there is no restriction on the rotation of the figure, we will check all possible angles where the question figure can fit itself in the option figures.

The question figure is embedded only in the first option figure.

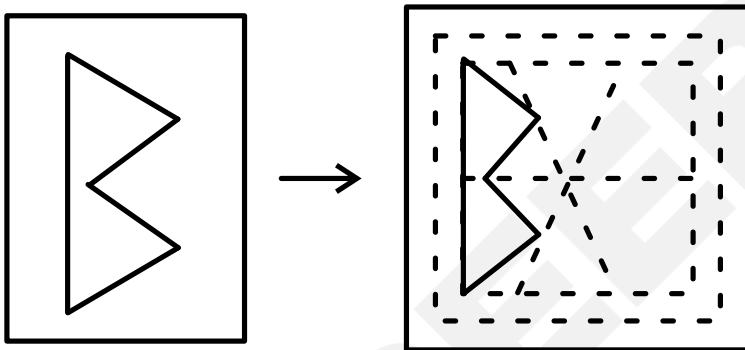

Hence, the **first option** is correct.

**Q. 78** **Directions:** From the given answer figure, select the one in which the question figure is hidden/embedded.

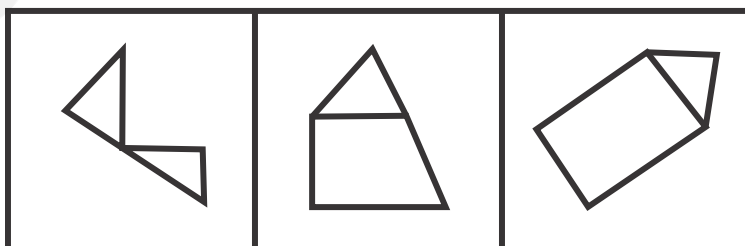

**Option 1:**

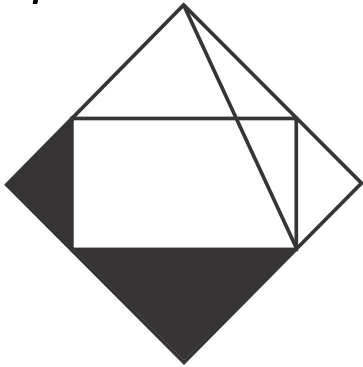

**Option 2:**

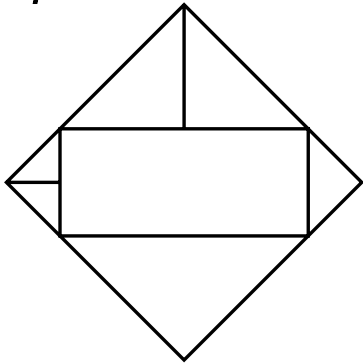

**Option 3:**

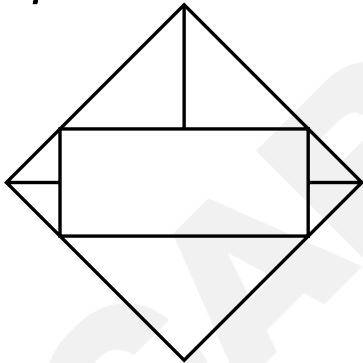

**Option 4:**

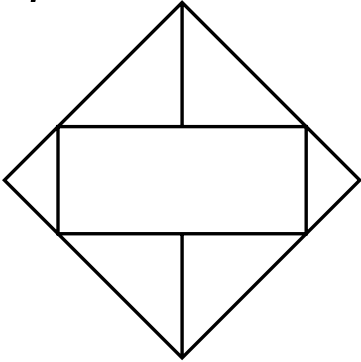

**Correct Answer:**

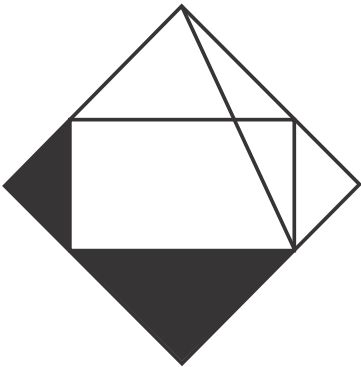

**Solution:**

As there is no restriction on the rotation of the figures, we will check all possible angles where all the question figures fit in the option figures.

The question figures are embedded in the first option and are represented by different colours in the figure below.

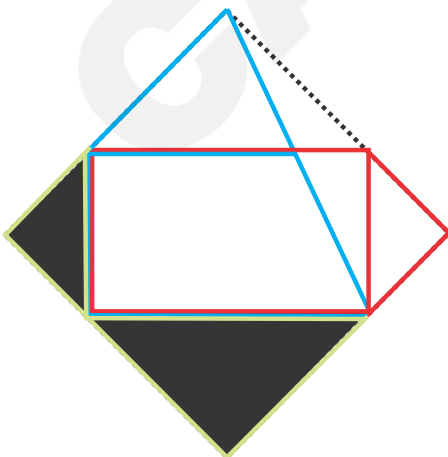

Hence, the **first option** is correct.

- Q. 79** **Directions:** From the given answer figures, select the one in which the question figure is hidden/embedded.

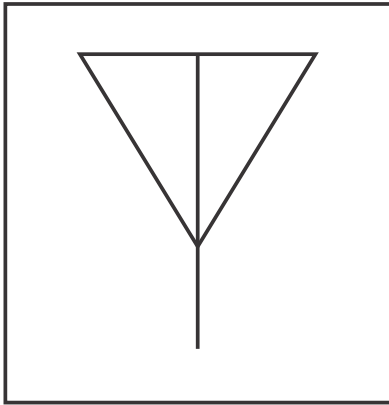

**Option 1:**

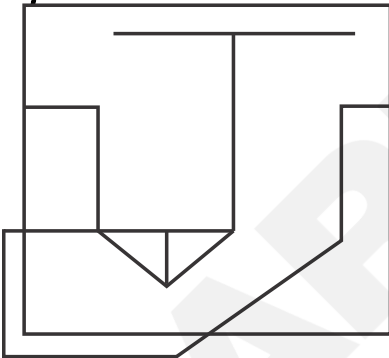

**Option 2:**

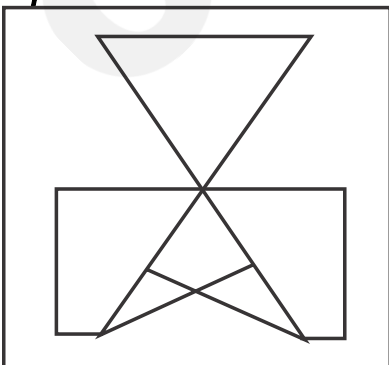

**Option 3:**

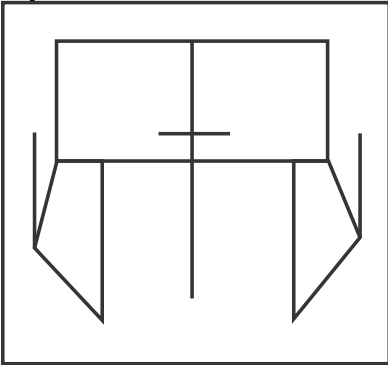

**Option 4:**

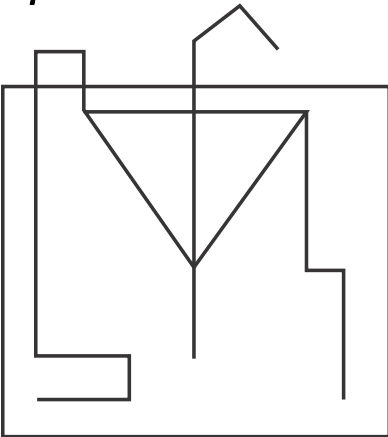

**Correct Answer:**

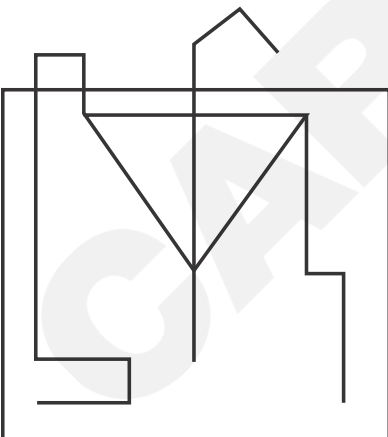

**Solution:**

As there is no restriction on the rotation of the figure, we will check all possible angles where the question figure fits in the option figures.

The question figure is embedded only in the fourth option figure.

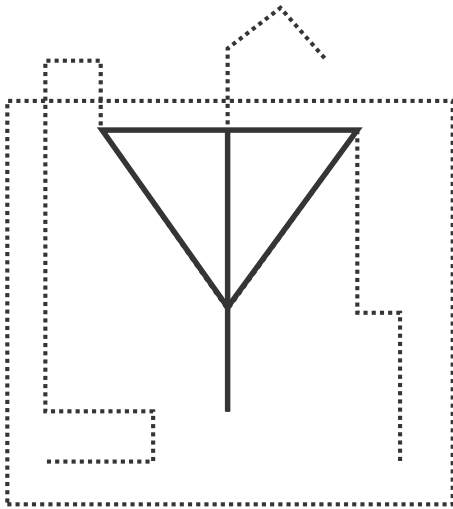

Hence, the **fourth option** is correct.

- Q. 80** **Directions:** From the given option figures, select the one in which the question figure is embedded.

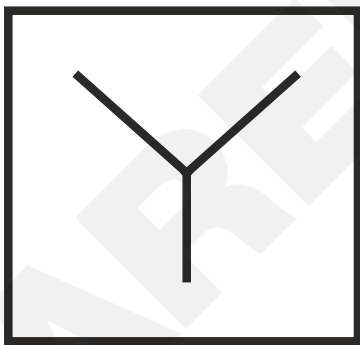

*Option 1:*

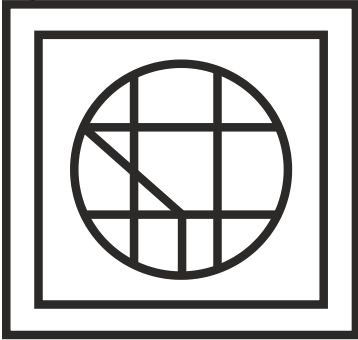

*Option 2:*

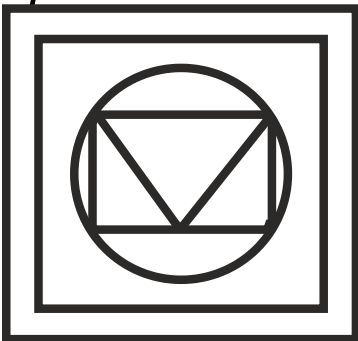

*Option 3:*

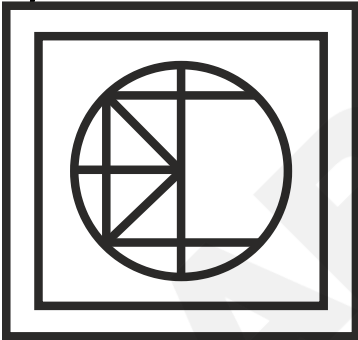

*Option 4:*

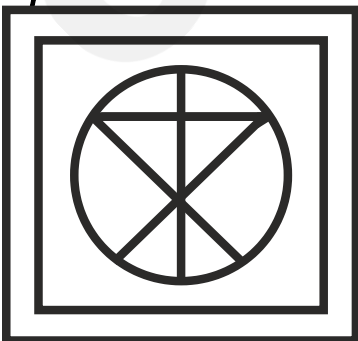

**Correct Answer:**

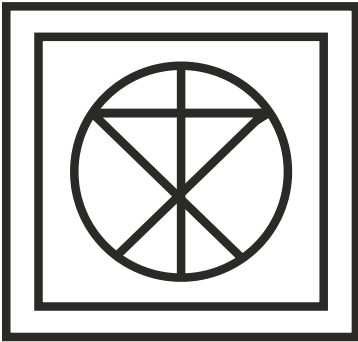

**Solution:**

As there is no restriction on the rotation of the figure, we will check all possible angles where the question figure fits in the option figures.

The question figure is embedded only in the fourth option figure.

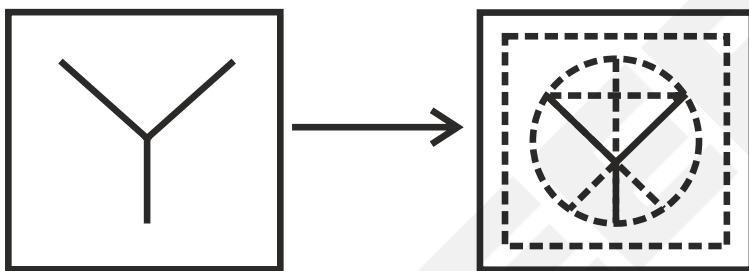

Hence, the **fourth option** is correct.

**Q. 81** **Directions:** From the given answer figures, select the one in which the question figure is hidden/embedded.

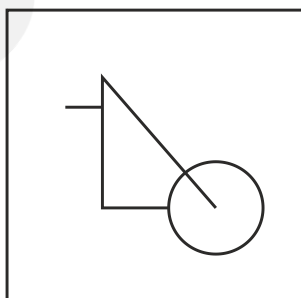

**Option 1:**

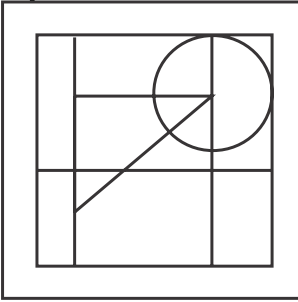

**Option 2:**

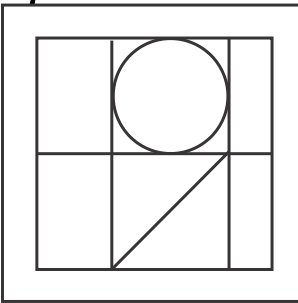

**Option 3:**

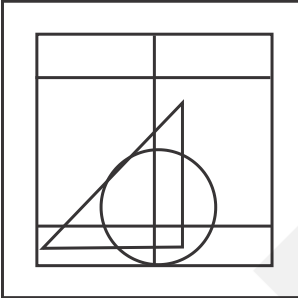

**Option 4:**

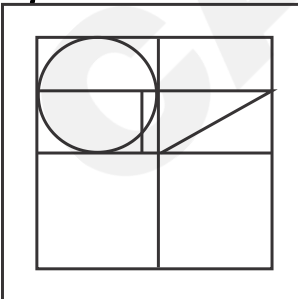

**Correct Answer:**

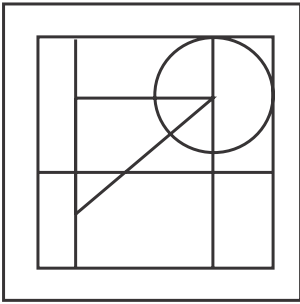

**Solution:**

Since there is no restriction on rotation, the question figure can be oriented in a different direction and still fit in an answer figure. On comparing the question figure and all the answer figures, the following figure will combine and make the complete pattern –

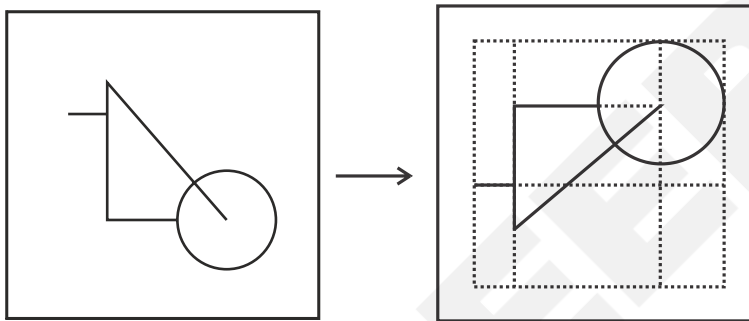

Hence, the **first option** is correct.

**Q. 82** **Directions:** From the given answer figures, select the one in which the question figure is hidden/embedded.

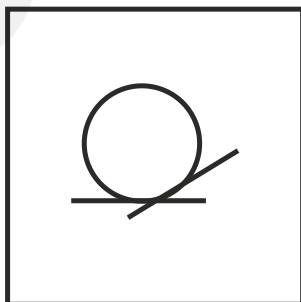

*Option 1:*

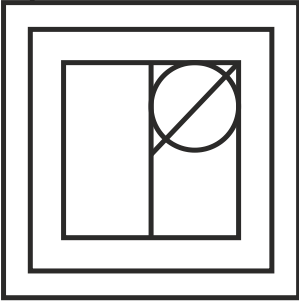

*Option 2:*

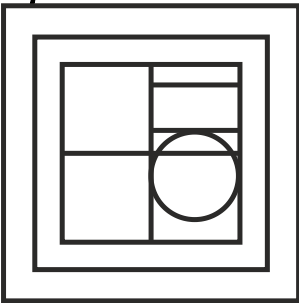

*Option 3:*

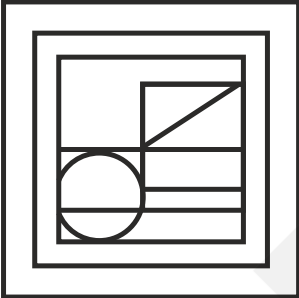

*Option 4:*

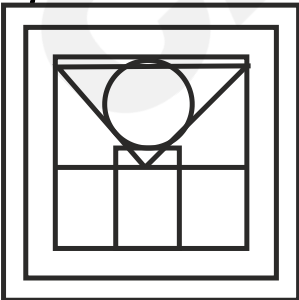

**Correct Answer:**

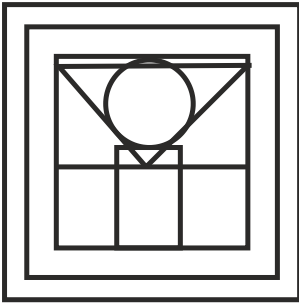

**Solution:**

Since there is no restriction on rotation, check all the possible angles at which the question figure can fit. By comparison of all the option figures, only the fourth option figure is embedded in the given question figure.

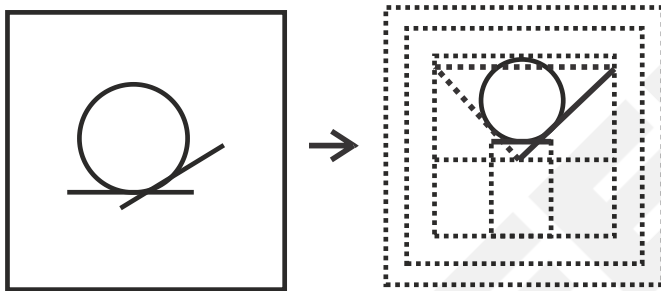

Hence, the **fourth option** is correct.

**Q. 83** **Directions:** Select the option figure in which the given figure is embedded (rotation is NOT allowed).

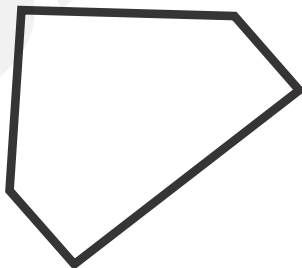

*Option 1:*

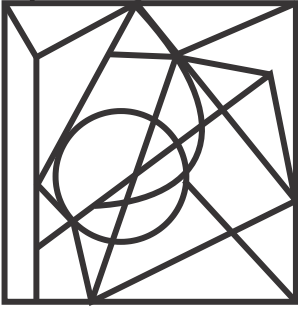

*Option 2:*

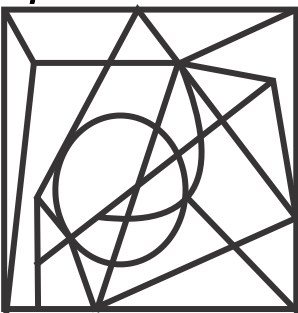

*Option 3:*

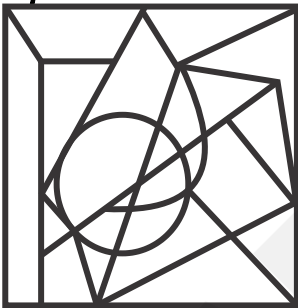

*Option 4:*

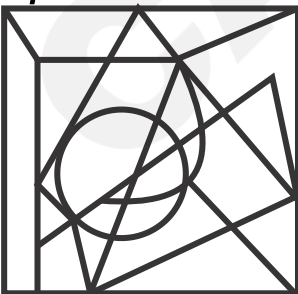

**Correct Answer:**

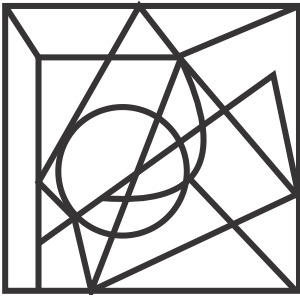

**Solution:**

Since the rotation is restricted. So, the embedded figure will have the same orientation as the main figure. By comparison of all the option figures, only the fourth option figure is embedded in the given question figure.

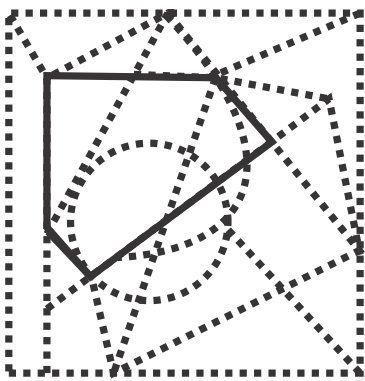

Hence, the **fourth option** is correct.

**Q. 84** **Directions:** Select the option figure in which the given figure is embedded as its part (rotation is NOT allowed).

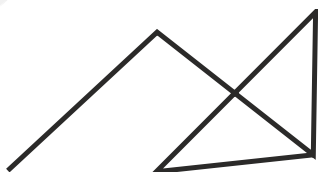

**Option 1:**

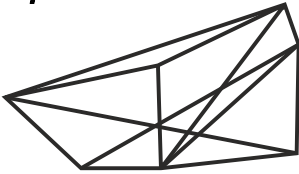

**Option 2:**

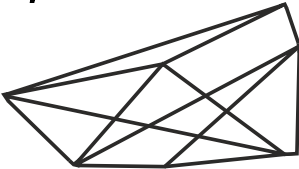

**Option 3:**

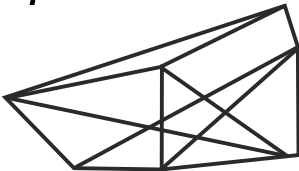

**Option 4:**

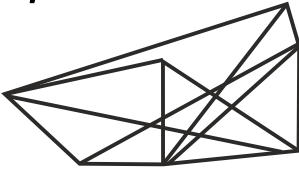

**Correct Answer:**

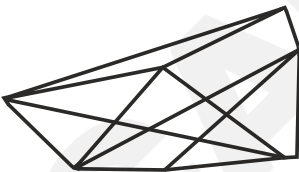

**Solution:**

As rotation is not allowed, check where the question figure fits in the option figures.

The question figure is embedded in the second option figure.

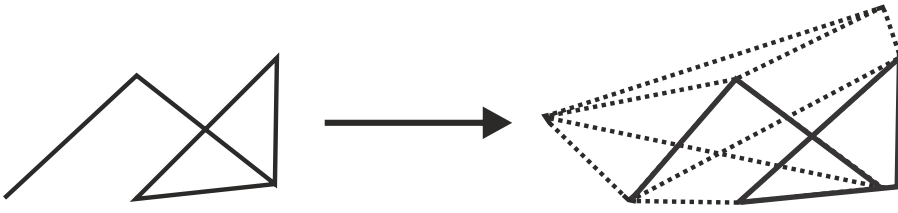

Hence, the **second option** is correct.

**Q. 85** **Directions:** Select the option figure in which the given figure is embedded. (Rotation is not allowed).

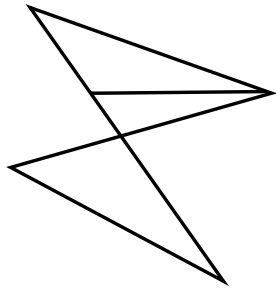

**Option 1:**

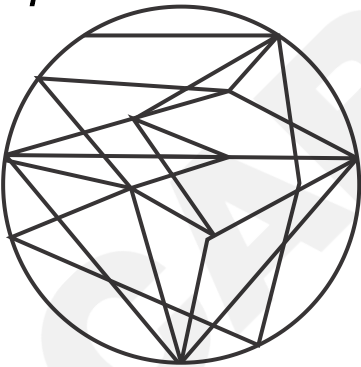

**Option 2:**

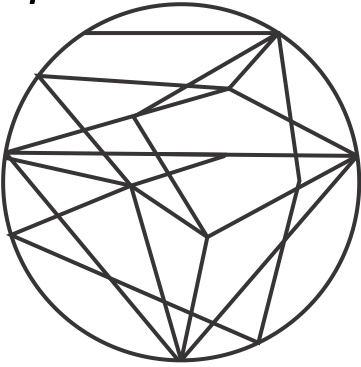

**Option 3:**

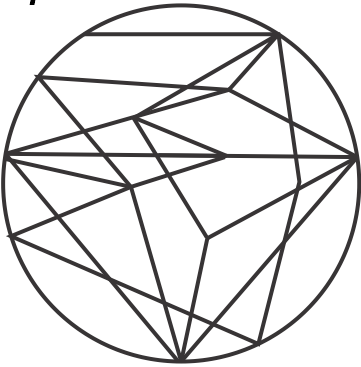

**Option 4:**

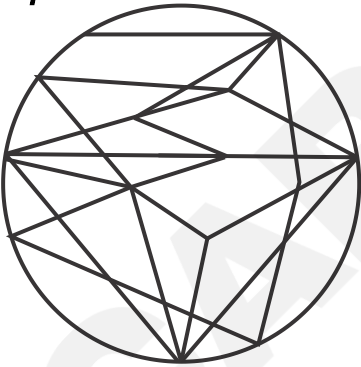

**Correct Answer:**

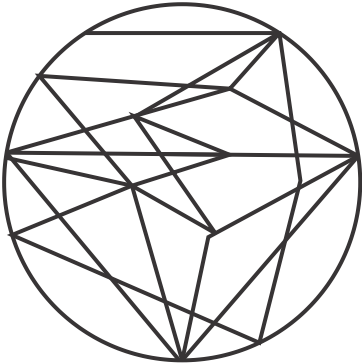

**Solution:**

Since the rotation of the figure is not allowed, check where the question figure fits in the option figures.

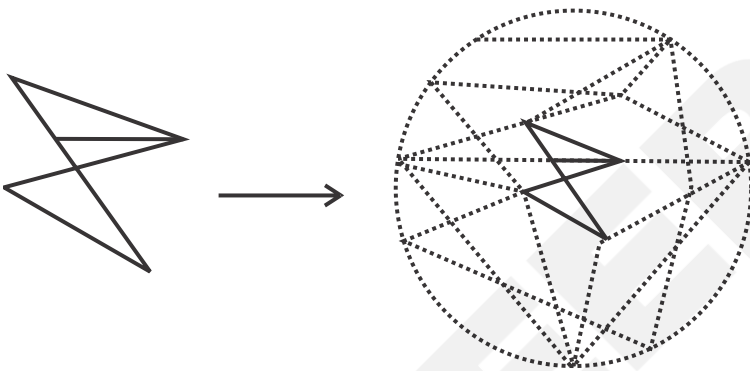

The question figure is embedded in the first option figure. Hence, the **first option** is correct.

- Q. 86** **Directions:** Select the option figure in which the given figure (X) is embedded as its part (rotation is NOT allowed).

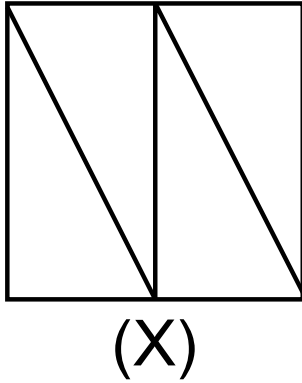

*Option 1:*

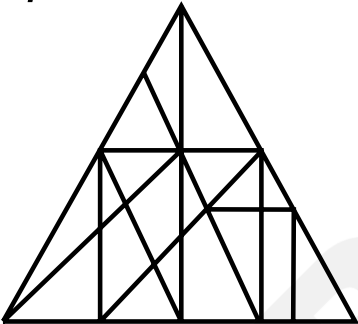

*Option 2:*

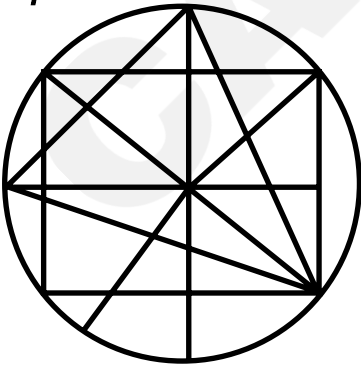

*Option 3:*

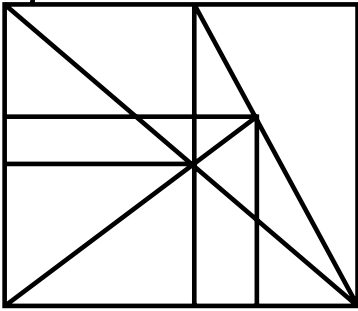

*Option 4:*

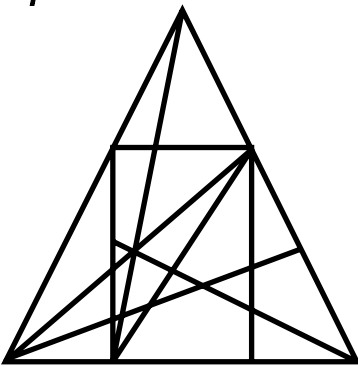

*Correct Answer:*

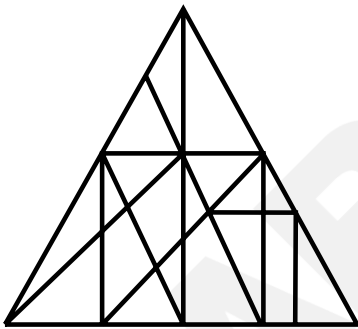

**Solution:**

Since the rotation of the figure is not allowed, now check where the question figure can exactly fit itself in the given option figures.

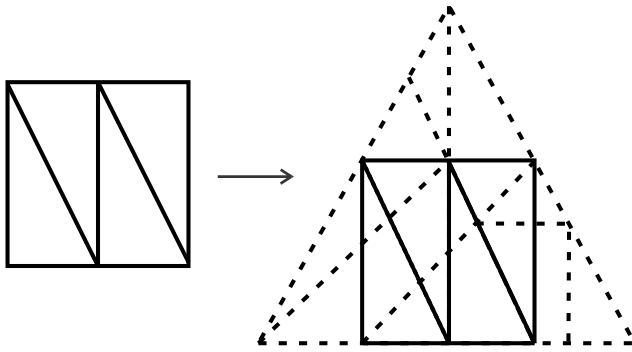

From the above, it is clear that the given question figure is embedded in the first option figure. Hence, the **first option** is correct.

- Q. 87** **Directions:** Select the option figure in which the given figure is embedded. (Rotation is not allowed).

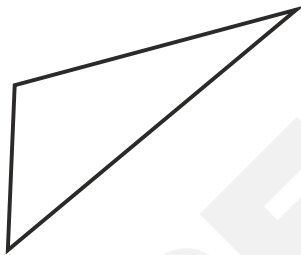

**Option 1:**

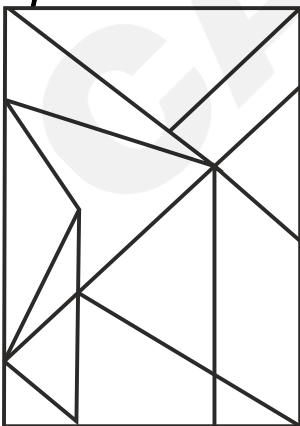

**Option 2:**

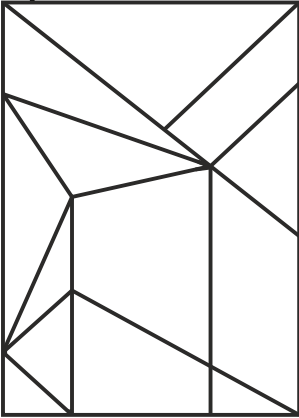

**Option 3:**

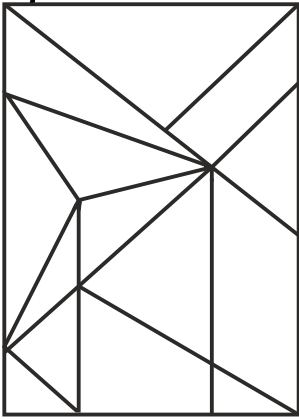

**Option 4:**

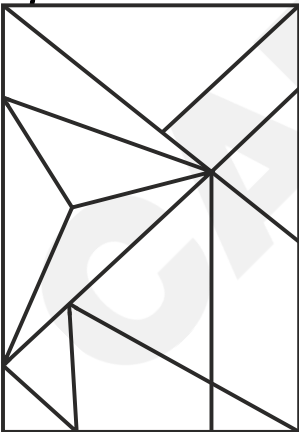

**Correct Answer:**

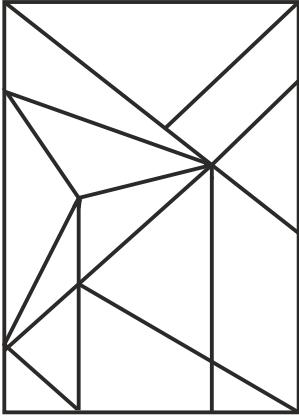

**Solution:**

Since the rotation of the figure is not allowed, we will check where the question figure can exactly fit itself in the given option figures.

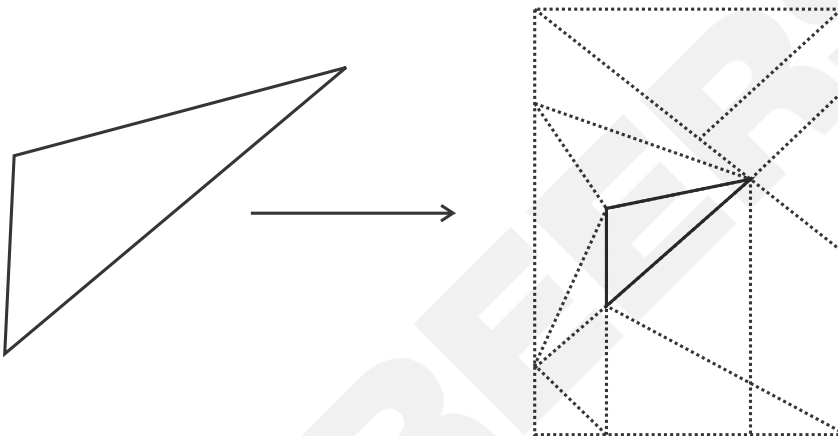

From the above, it is clear that the given question figure is embedded in the third option figure. Hence, the **third option** is correct.

**Q. 88** **Directions:** Select the option figure in which the given figure is embedded (rotation is NOT allowed).

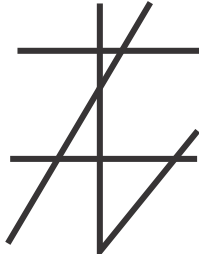

**Option 1:**

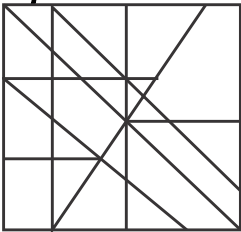

**Option 2:**

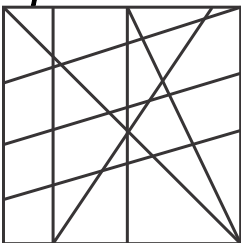

**Option 3:**

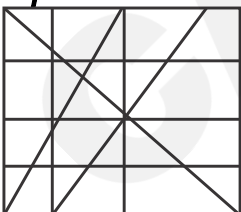

**Option 4:**

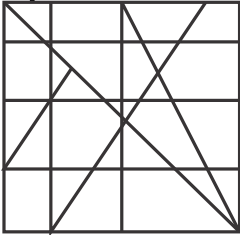

**Correct Answer:**

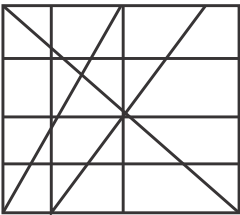

**Solution:**

Because there is no restriction on the rotation of the figure, we will check all the possible angles where the question figure can fit itself in the given option figures.

By comparison of all the option figures, the given question figure is embedded only in the third option figure.

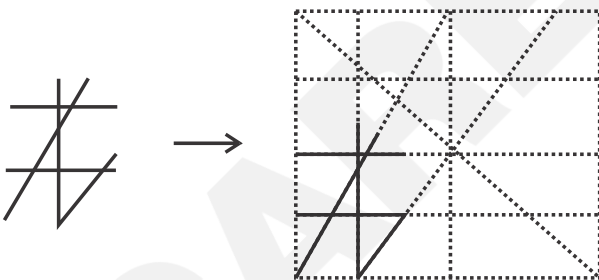

Hence, the **third option** is correct.

- Q. 89** **Directions:** Select the option figure that is embedded in the given figure (rotation is NOT allowed).

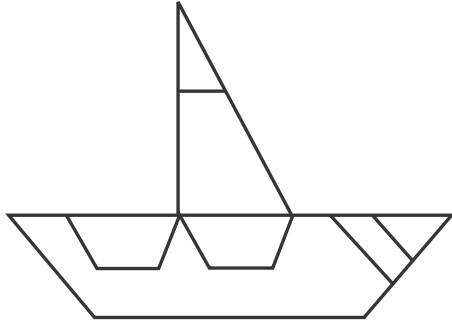

**Option 1:**

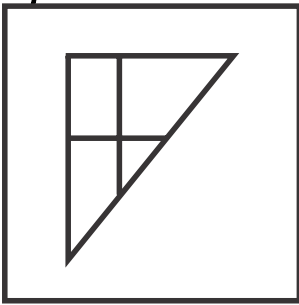

**Option 2:**



**Option 3:**

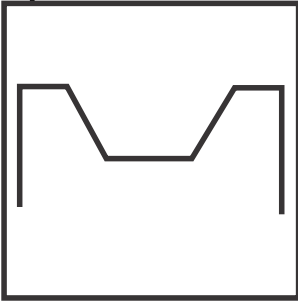

**Option 4:**

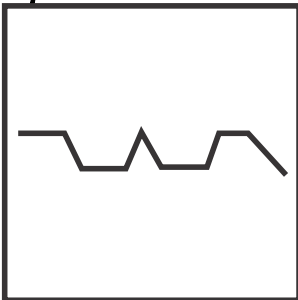

**Correct Answer:**



**Solution:**

Since the rotation is restricted. So, the embedded figure will have the same orientation as the main figure. By comparison of all the option figures, only the fourth option figure is embedded in the given question figure.

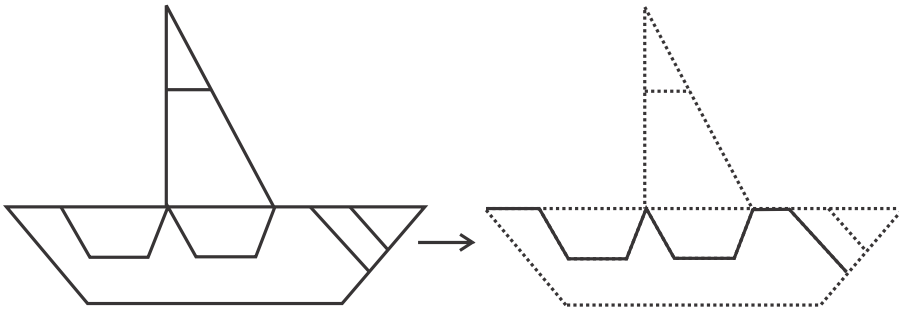

Hence, the **fourth option** is correct.

- Q. 90** **Directions:** Select the option figure in which the given figure is embedded (rotation is NOT allowed).

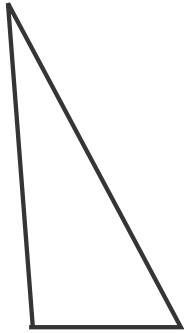

**Option 1:**

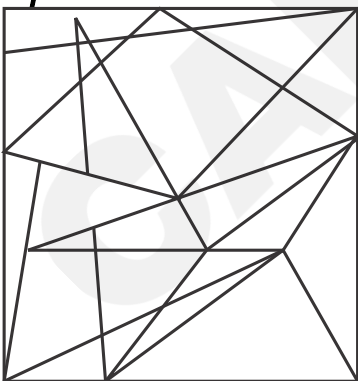

**Option 2:**

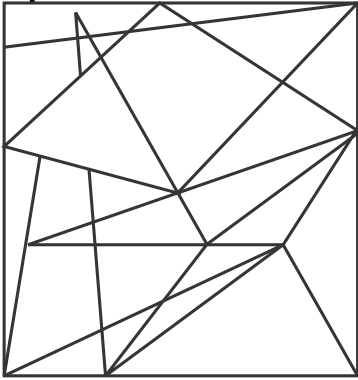

**Option 3:**

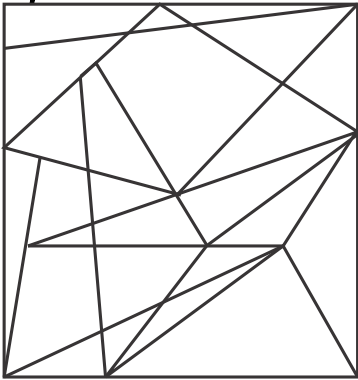

**Option 4:**

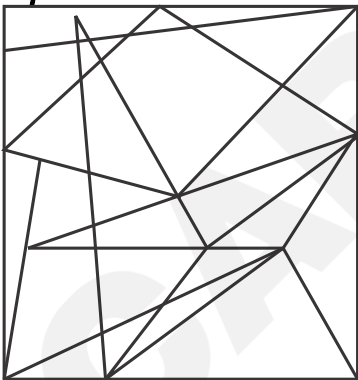

**Correct Answer:**

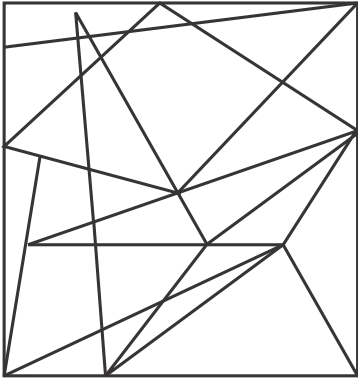

**Solution:**

Since the rotation is restricted, the embedded figure will have the same orientation as the main figure. By comparison of the question figure with all the option figures, the given question figure is embedded only in the fourth option figure.

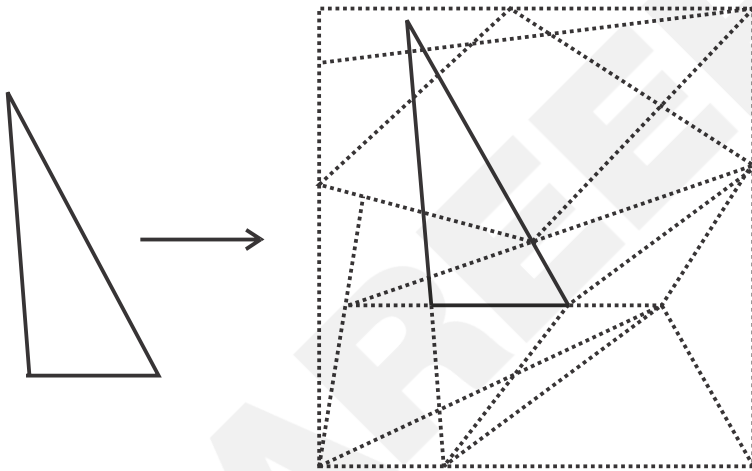

Hence, the **fourth option** is correct.

- Q. 91** **Directions:** Select the option in which the given figure is embedded (rotation is NOT allowed).

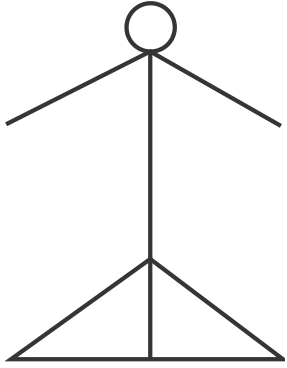

**Option 1:**

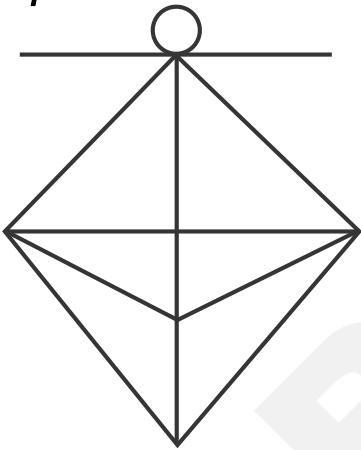

**Option 2:**

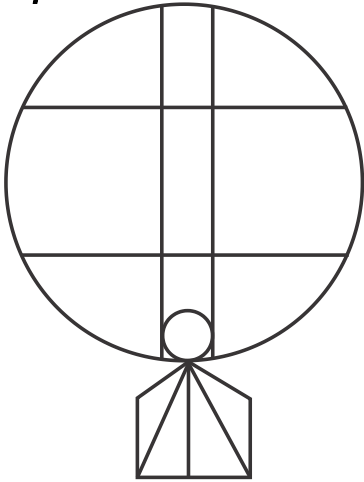

**Option 3:**

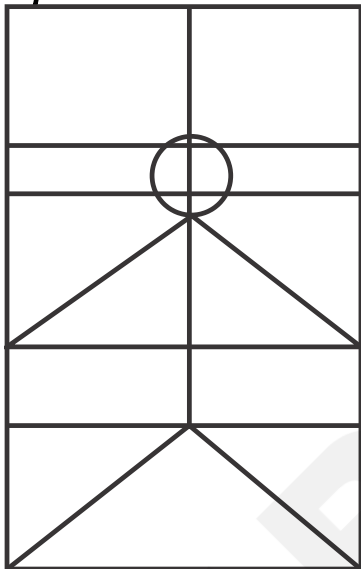

**Option 4:**

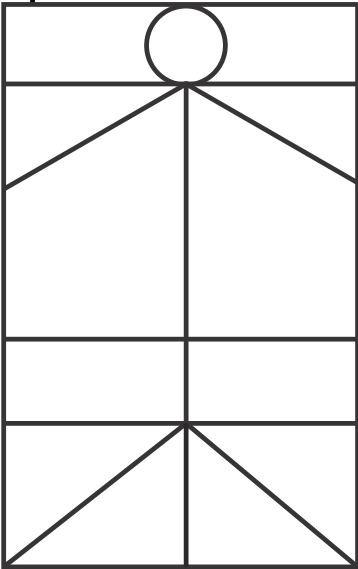

**Correct Answer:**

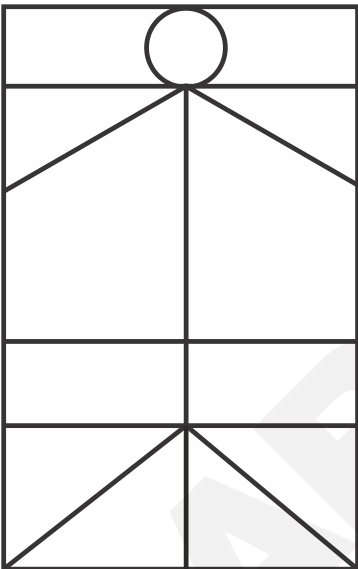

**Solution:**

Since the rotation of the figure is not allowed, we will check where the question figure can exactly fit itself in the given option figures.

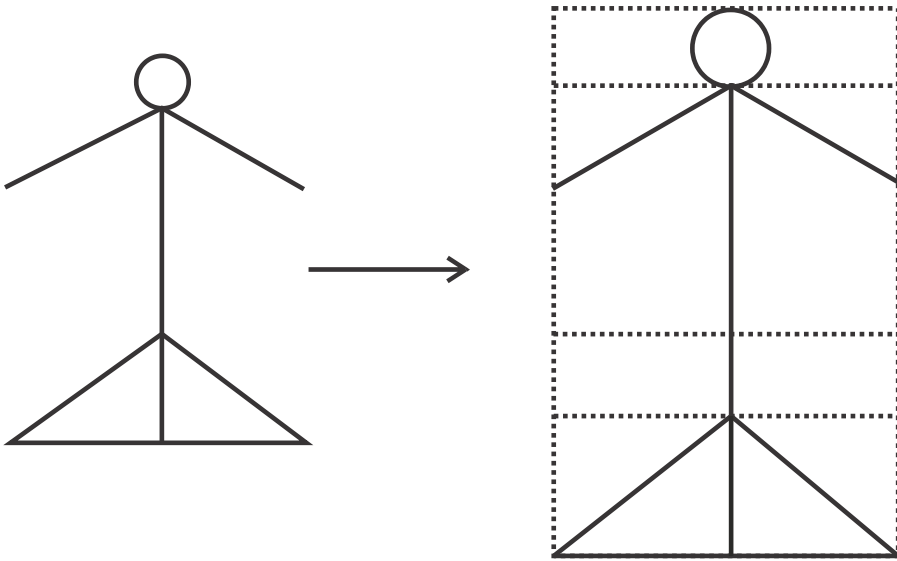

From the above, it is clear that the question figure is embedded in the fourth option figure. Hence, the **fourth option** is correct.

**Q. 92** **Directions:** Select the option figure in which the given figure is embedded. (Rotation is NOT allowed)

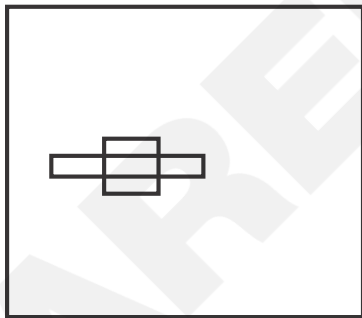

**Option 1:**

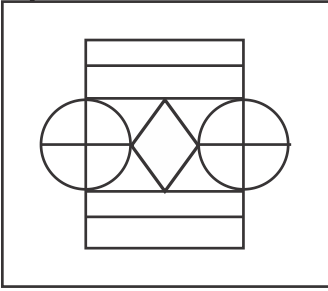

**Option 2:**

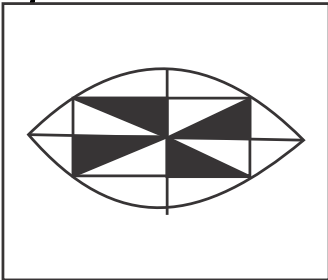

**Option 3:**

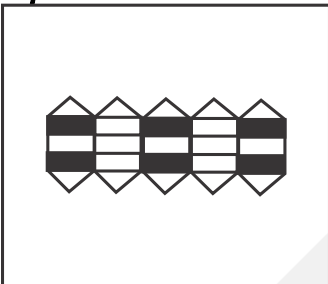

**Option 4:**

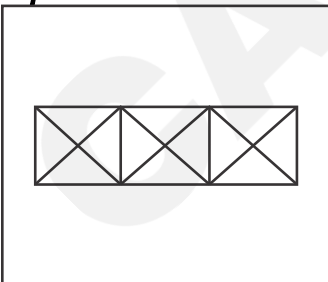

**Correct Answer:**

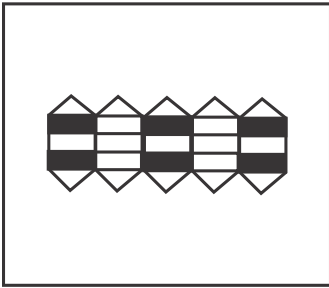

**Solution:**

Since the rotation is restricted. So, the embedded figure will have the same orientation as the main figure. By comparison of the question figure with all the option figures, the given question figure is embedded only in the third option figure.

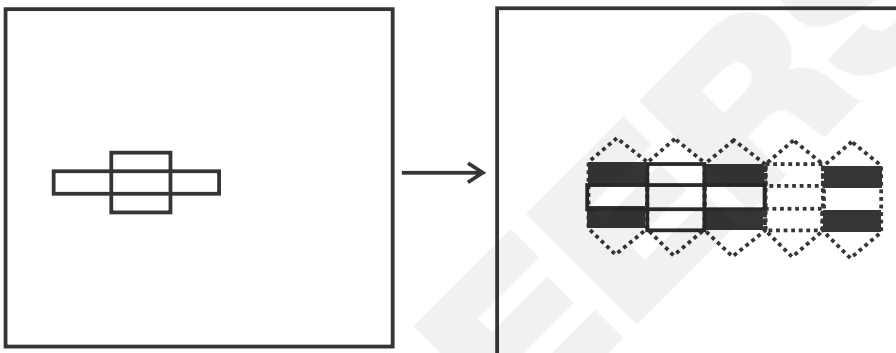

Hence, the **third option** is correct.

**Q. 93** **Directions:** Select the option figure in which the given figure is embedded. (Rotation is NOT allowed.)

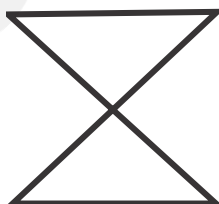

**Option 1:**

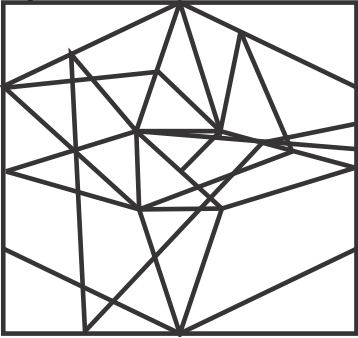

**Option 2:**

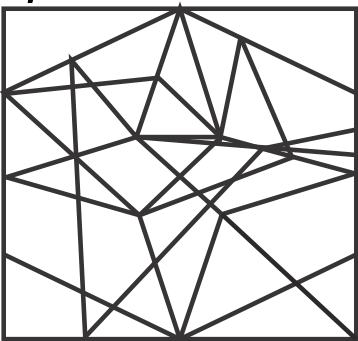

**Option 3:**

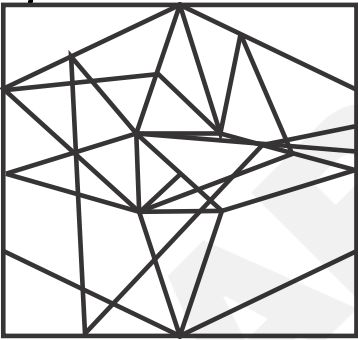

**Option 4:**

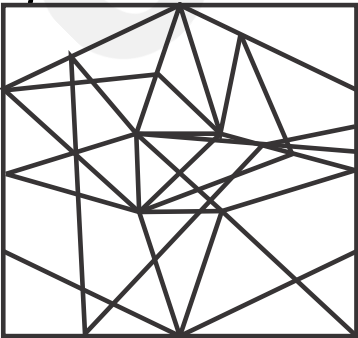

**Correct Answer:**

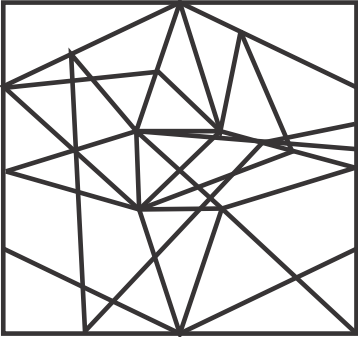

**Solution:**

Since the rotation of the figure is not allowed, we will check where the question figure can exactly fit itself in the given option figures. By comparison of all the option figures, the given question figure is embedded only in the fourth option figure.

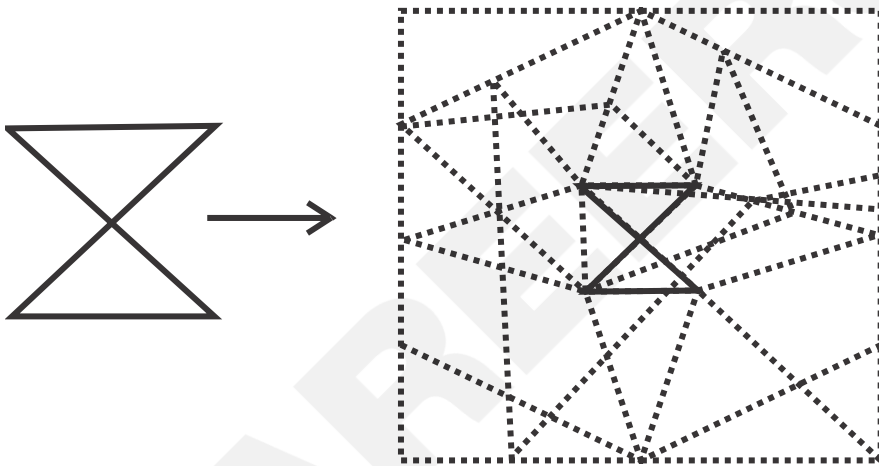

Hence, the **fourth option** is correct.

- Q. 94** **Directions:** Select the option figure in which the given figure is embedded (rotation is NOT allowed).

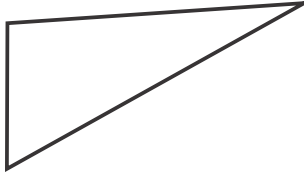

**Option 1:**

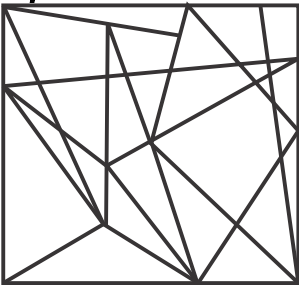

**Option 2:**

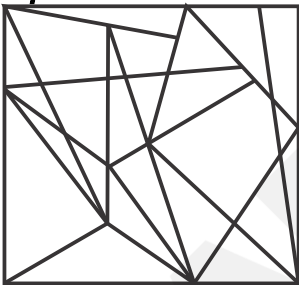

**Option 3:**

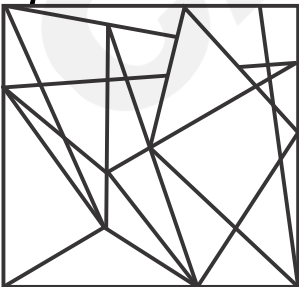

**Option 4:**

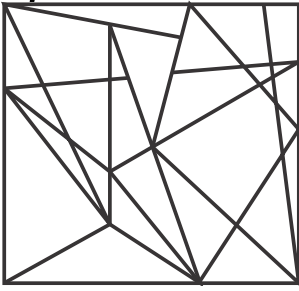

**Correct Answer:**

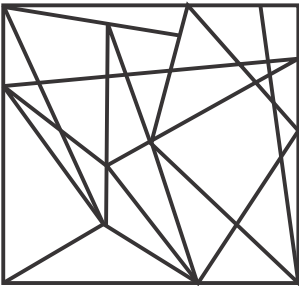

**Solution:**

Since the rotation of the figure is not allowed, we will check where the question figure can exactly fit itself in the given option figures.

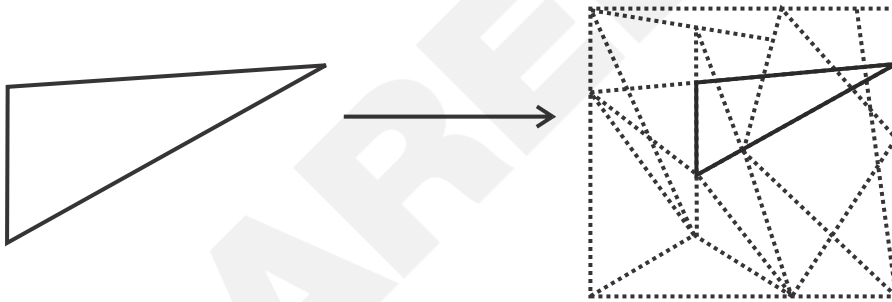

From the above, it is clear that the given question figure is embedded in the first option figure. Hence, the **first option** is correct.

- Q. 95** **Directions:** Select the option figure in which the given figure is embedded (rotation is NOT allowed).

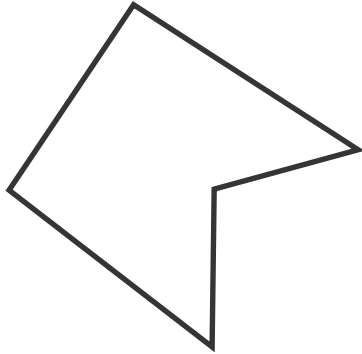

**Option 1:**

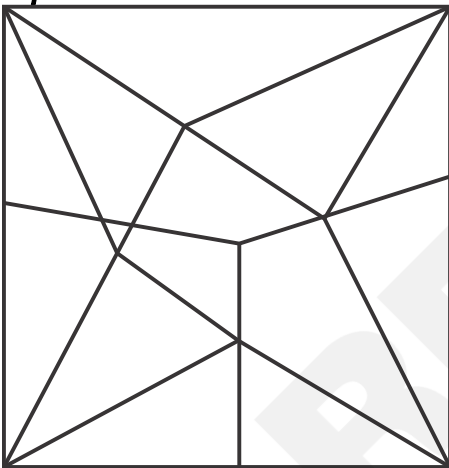

**Option 2:**

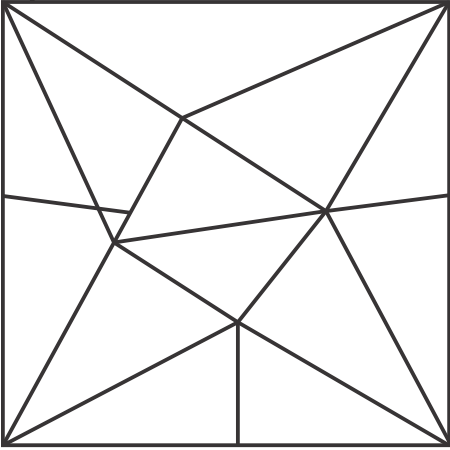

**Option 3:**

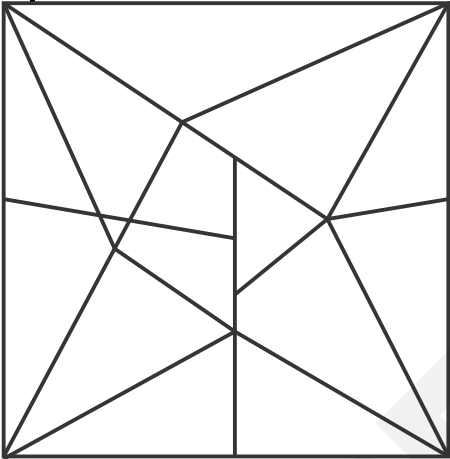

**Option 4:**

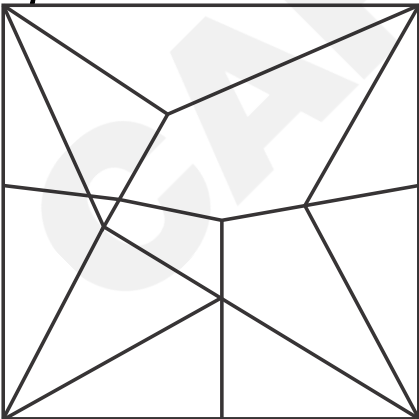

**Correct Answer:**

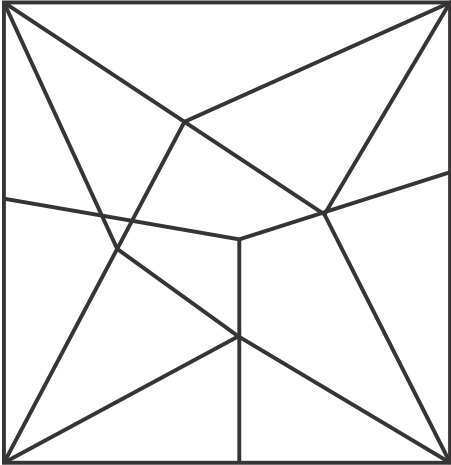

**Solution:**

Since the rotation of the figure is not allowed, we will check where the question figure can exactly fit itself in the given option figures.

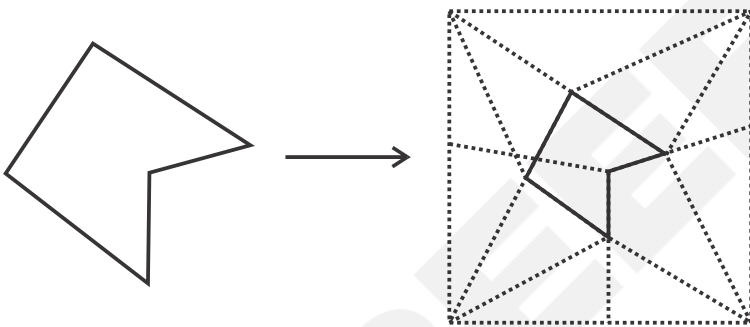

From the above, it is clear that the given question figure is embedded in the first option figure. Hence, the **first option** is correct.

- Q. 96** **Directions:** Select the option figure in which the given figure is embedded. (Rotation is NOT allowed)

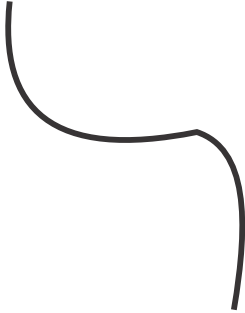

**Option 1:**

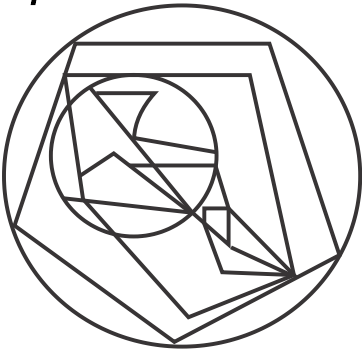

**Option 2:**

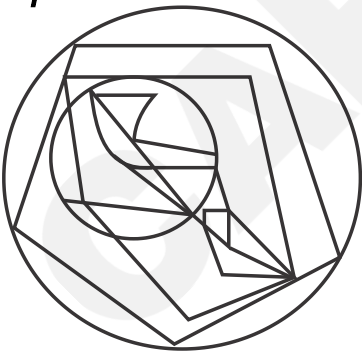

**Option 3:**

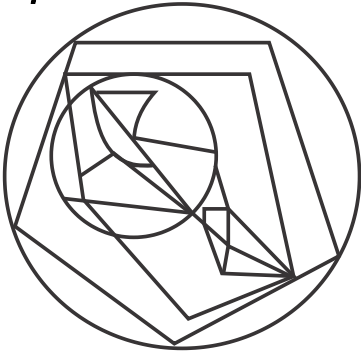

**Option 4:**

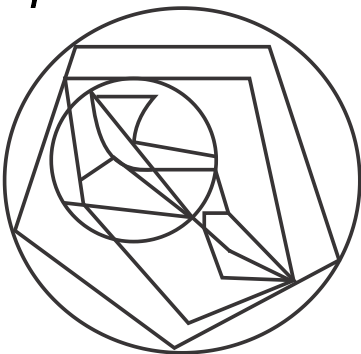

**Correct Answer:**

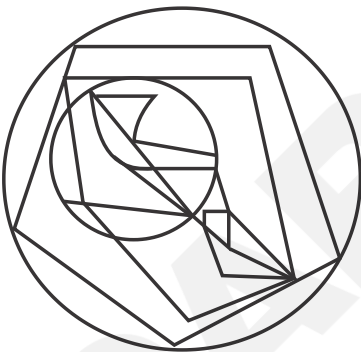

**Solution:**

Since the rotation of the figure is not allowed, we will check where the question figure can exactly fit itself in the given option figures.

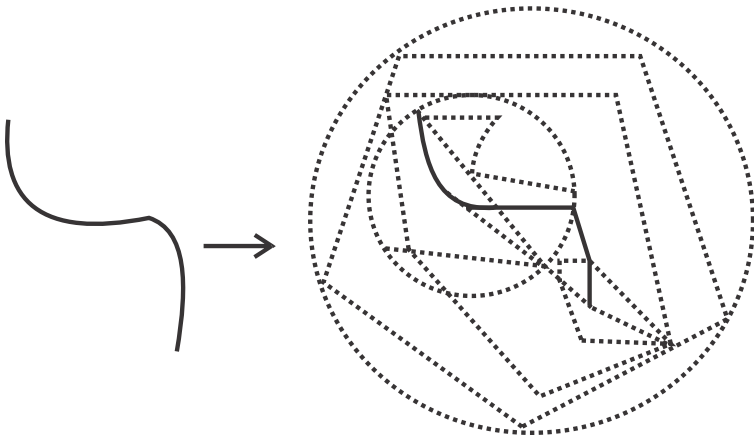

From the above, it is clear that the given question figure is embedded in the second option figure. Hence, the **second option** is correct.

**Q. 97** **Directions:** Select the option figure in which the given figure is embedded (rotation is NOT allowed).

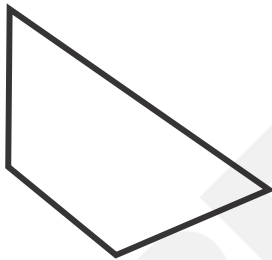

**Option 1:**

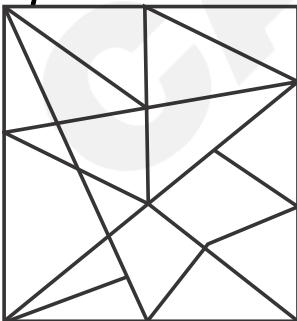

**Option 2:**

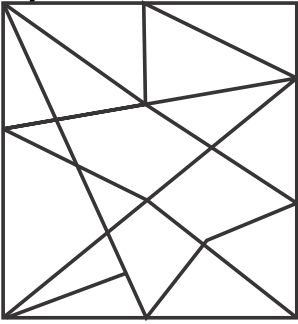

**Option 3:**

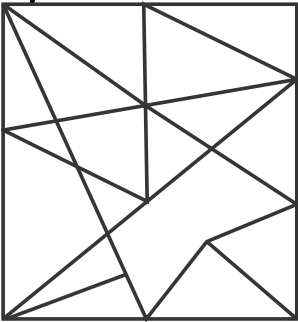

**Option 4:**

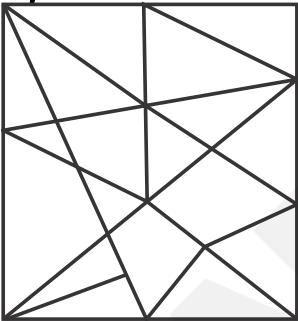

**Correct Answer:**

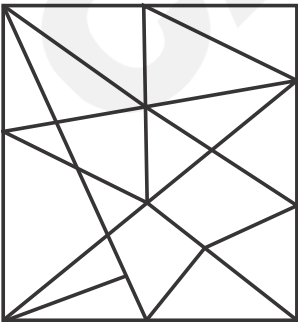

**Solution:**

Since the rotation is restricted, the embedded figure will have the same orientation as the main figure. By comparison of the question figure with all the option figures, the given question figure is embedded only in the fourth option figure.

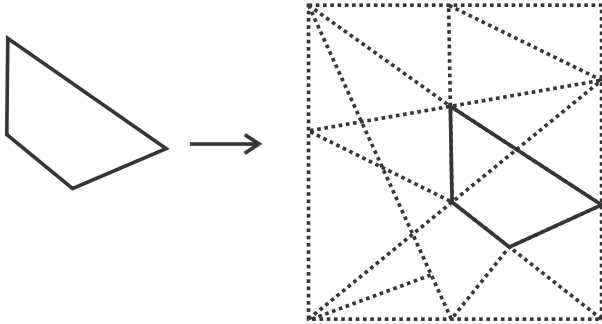

Hence, the **fourth option** is correct.

- 
- Q. 98**    **Directions:** Select the option figure in which the given figure is embedded (rotation is NOT allowed).

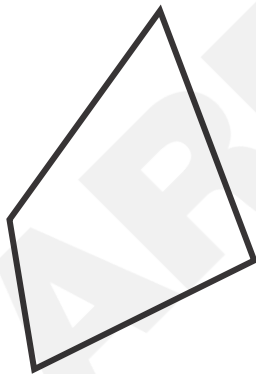

**Option 1:**

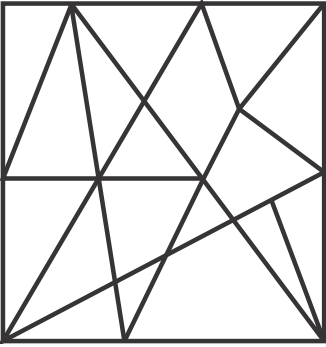

**Option 2:**

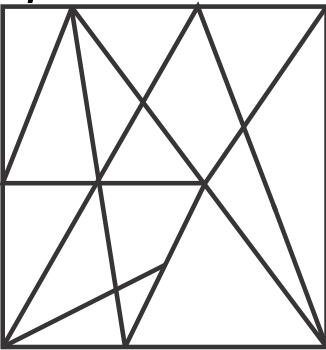

**Option 3:**

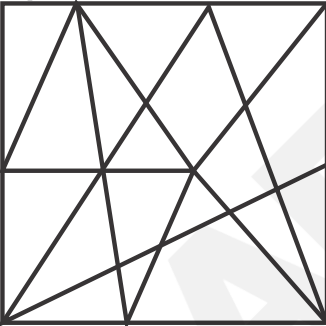

**Option 4:**

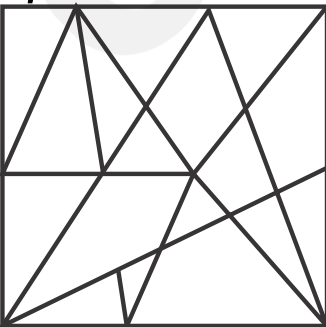

**Correct Answer:**

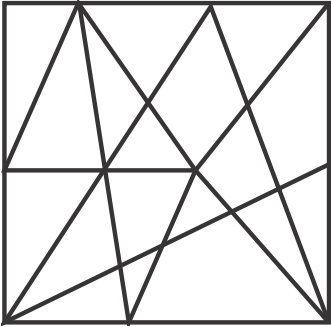

**Solution:**

Since the rotation of the figure is not allowed, we will check where the question figure can exactly fit itself in the given option figures.

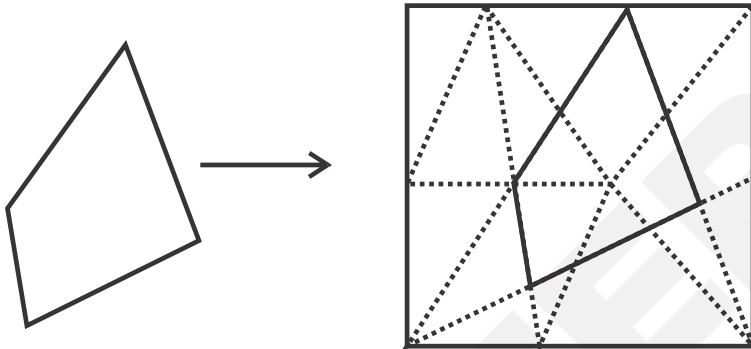

From the above, it is clear that the given question figure is embedded in the third option figure. Hence, the **third option** is correct.

- Q. 99** **Directions:** Select the option figure in which the given figure is embedded (rotation is NOT allowed).

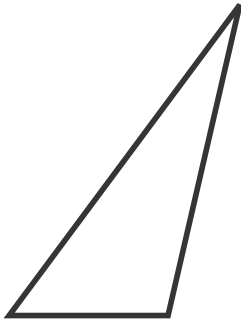

**Option 1:**

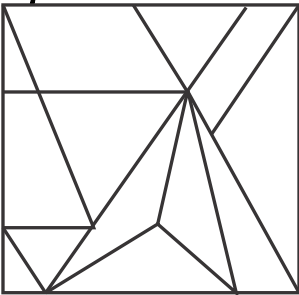

**Option 2:**

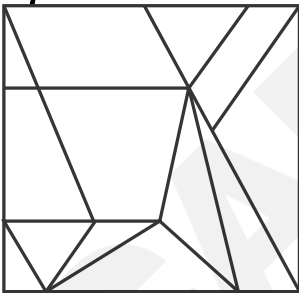

**Option 3:**

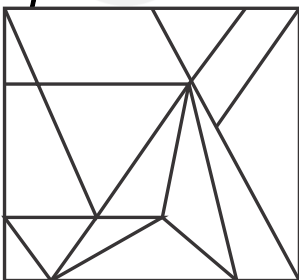

**Option 4:**

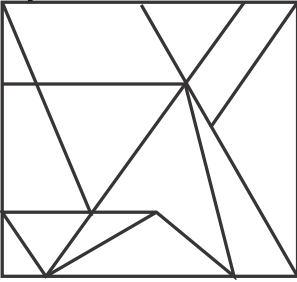

**Correct Answer:**

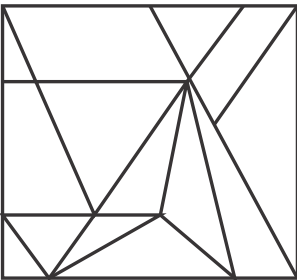

**Solution:**

Since the rotation is restricted. So, the embedded figure will have the same orientation as the main figure. By comparison of all the option figures, only the third option figure is embedded in the given question figure.

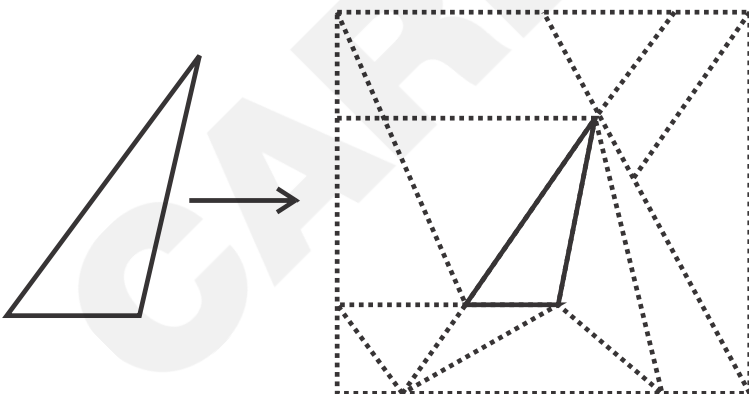

Hence, the **third option** is correct.

Q.  
100

**Directions:** From the given answer figures, select the one in which the question figure is hidden/embedded.

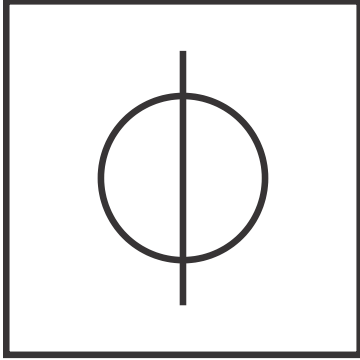

*Option 1:*

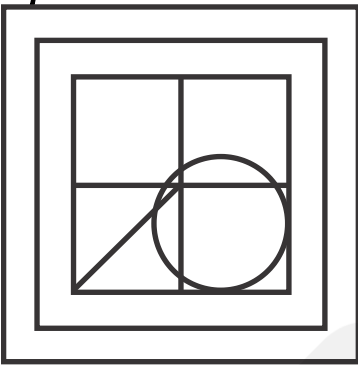

*Option 2:*

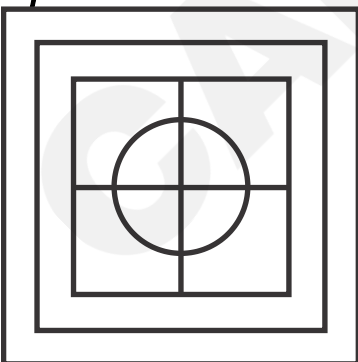

**Option 3:**

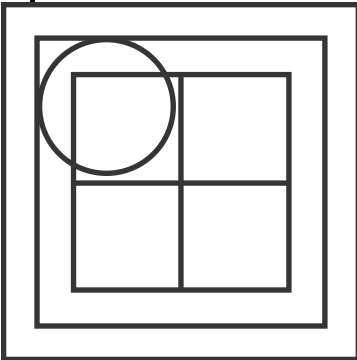

**Option 4:**

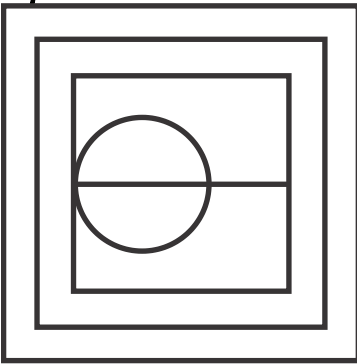

**Correct Answer:**

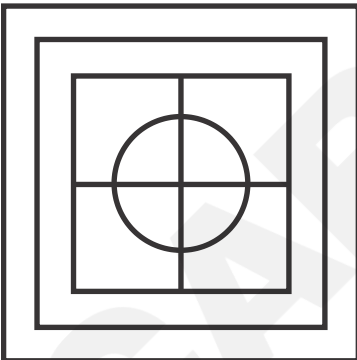

**Solution:**

Because there is no restriction on the rotation of the figure, we will check all the possible angles where the question figure can fit itself in the given option figures.

By comparison of all the option figures, the given question figure is embedded only in the second option figure.

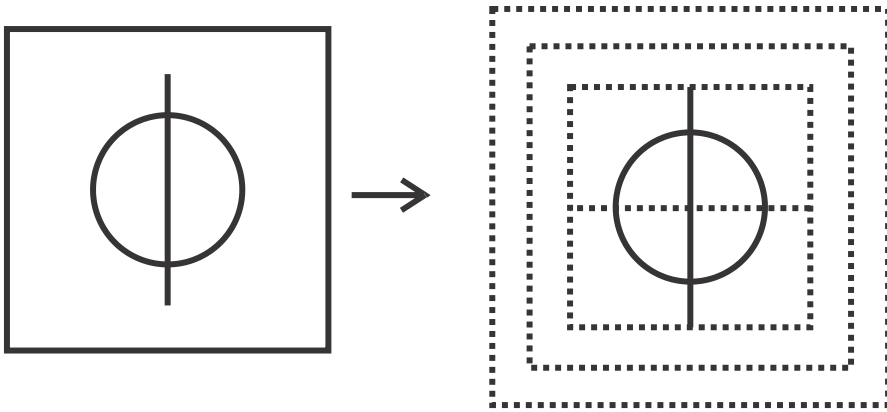

Hence, the **second option** is correct.

**Q.  
101**

**Directions:** From the given answer figures, select the one in which the question figure is hidden/embedded.

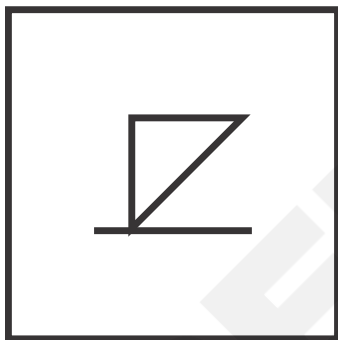

**Option 1:**

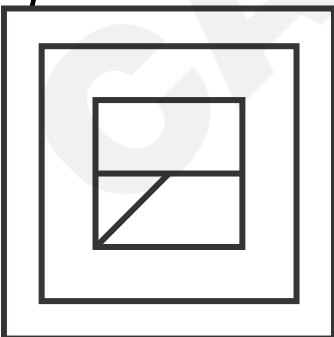

*Option 2:*

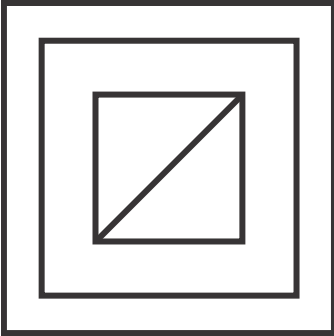

*Option 3:*

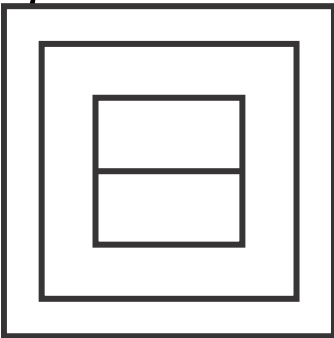

*Option 4:*

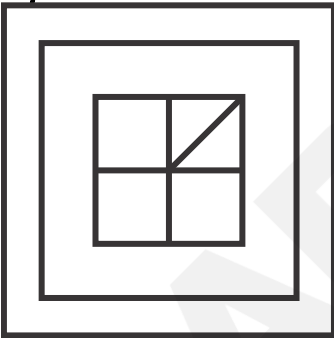

*Correct Answer:*

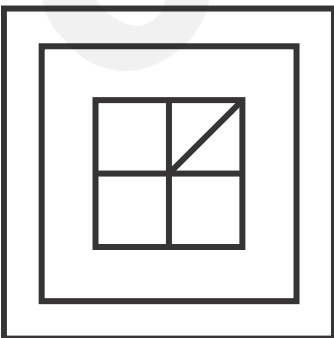

**Solution:**

Because there is no restriction on the rotation of the figure, we will check all the possible angles where the question figure can fit itself in the given option figures.

By comparison of all the option figures, the given question figure is embedded only in the fourth option figure.

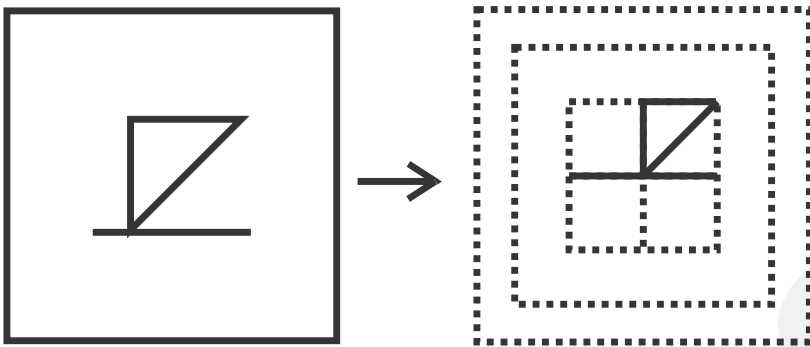

Hence, the **fourth option** is correct.

**Q.**  
**102**

**Directions:** From the given answer figures, select the one in which the question figure is hidden/embedded.

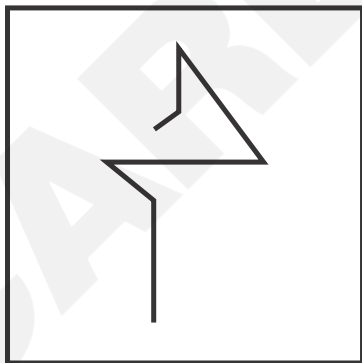

**Option 1:**

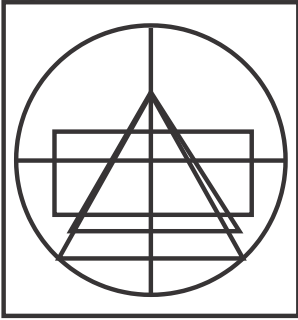

**Option 2:**



**Option 3:**

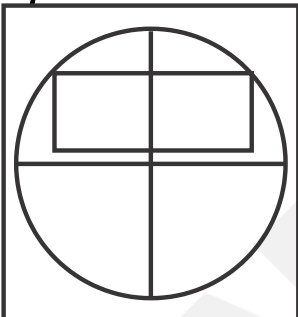

**Option 4:**



**Correct Answer:**



**Solution:**

We can find the embedded image in the fourth option as the rotation is not restricted. So after rotating the image of the fourth option in a  $270^\circ$  clockwise direction or  $90^\circ$  in an anticlockwise direction, the given question figure is embedded in the fourth option figure.

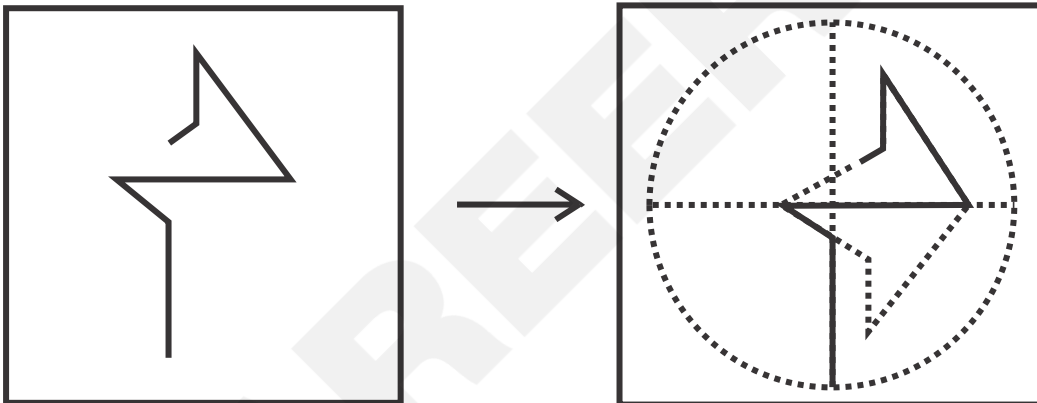

Hence, the **fourth option** is correct.

Q.  
103

**Directions:** From the given answer figures, select the one in which the question figure is hidden/embedded.

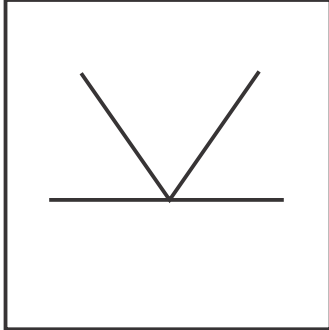

**Option 1:**

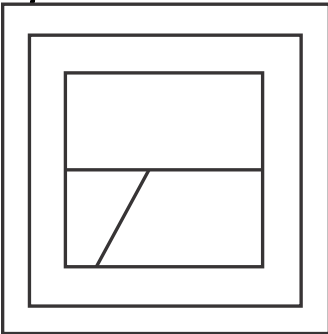

**Option 2:**

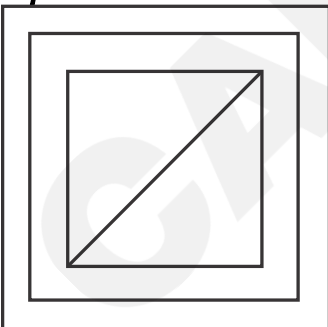

**Option 3:**

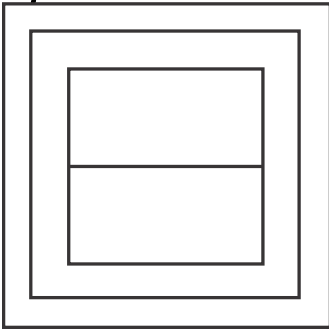

**Option 4:**

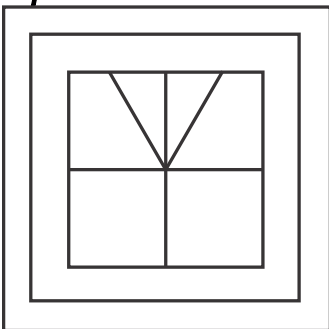

**Correct Answer:**

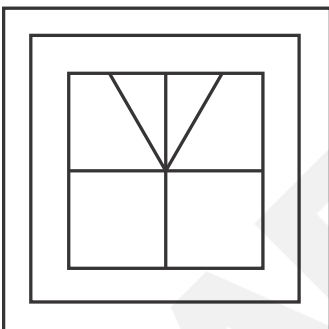

**Solution:**

Because there is no restriction on the rotation of the figure, we will check all the possible angles where the question figure can fit itself in the given option figures.

By comparison of all the option figures, the given question figure is embedded only in the fourth option figure.

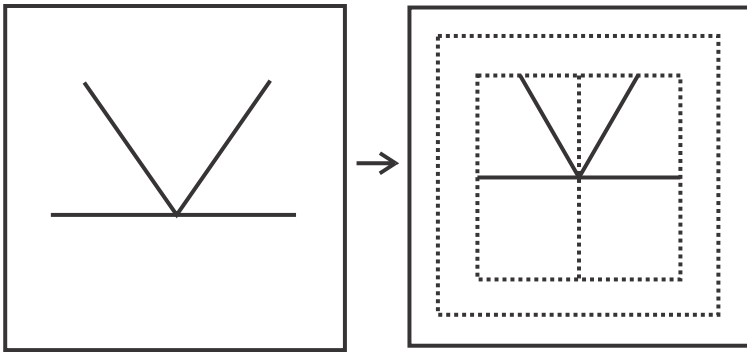

Hence, the **fourth option** is correct.

**Q.**  
**104**

**Directions:** From the given answer figures, select the one in which the question figure is hidden/embedded.

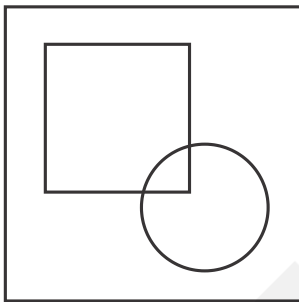

**Option 1:**

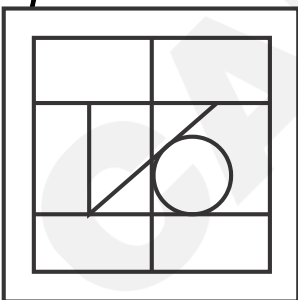

**Option 2:**

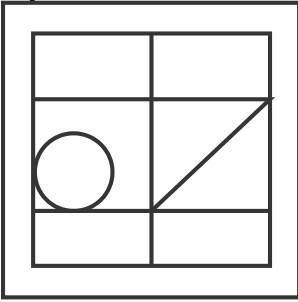

**Option 3:**

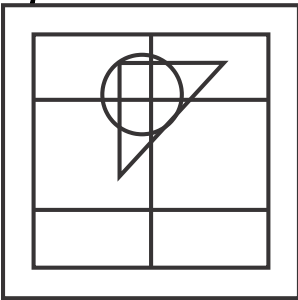

**Option 4:**

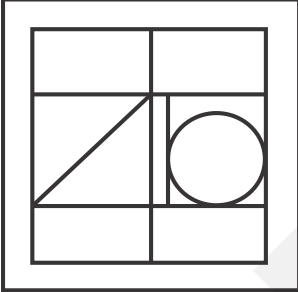

**Correct Answer:**

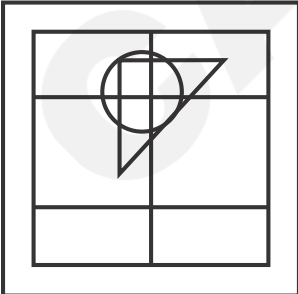

**Solution:**

Because there is no restriction on the rotation of the figure, we will check all the possible angles where the question figure can fit itself in the given option figures.

By comparison of all the option figures, the given question figure is embedded only in the third option figure.

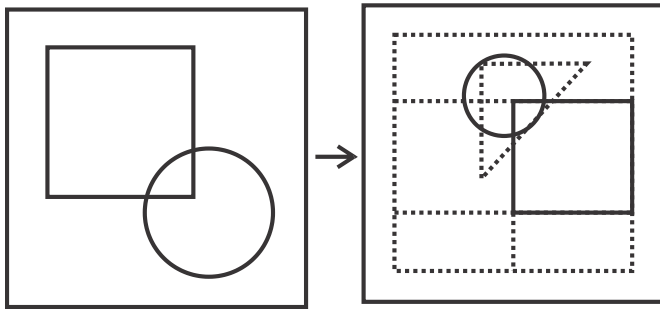

Hence, the **third option** is correct.

**Q.**  
**105**

**Directions:** From the given answer figures, select the one in which the question figure is hidden/embedded.

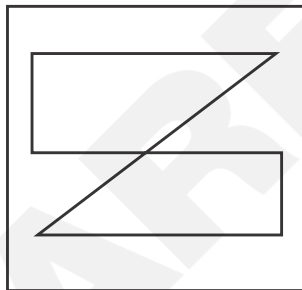

**Option 1:**

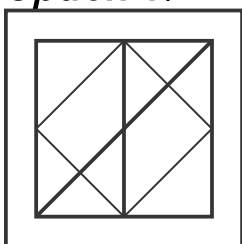

**Option 2:**

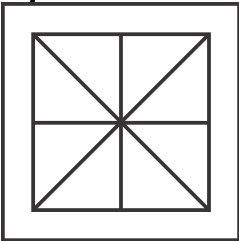

**Option 3:**

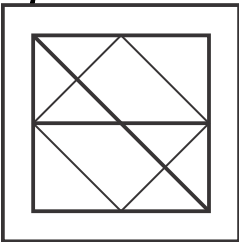

**Option 4:**

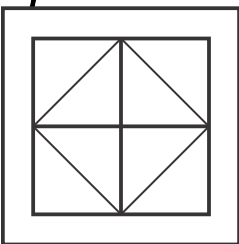

**Correct Answer:**

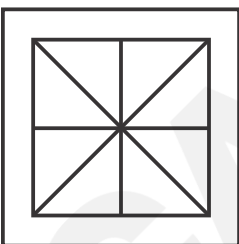

**Solution:**

Because there is no restriction on the rotation of the figure, we will check all the possible angles where the question figure can fit itself in the given option figures.

By comparison of all the option figures, the given question figure is embedded only in the second option figure.

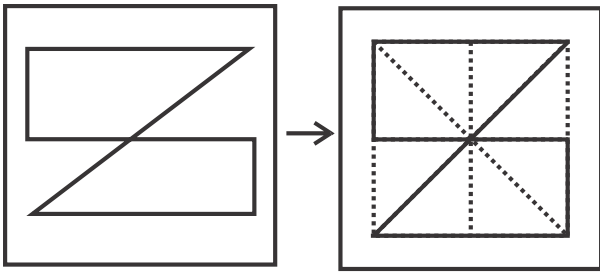

Hence, the **second option** is correct.

**Q.**  
**106**

**Directions:** From the given answer figures, select the one in which the question figure is hidden/embedded.

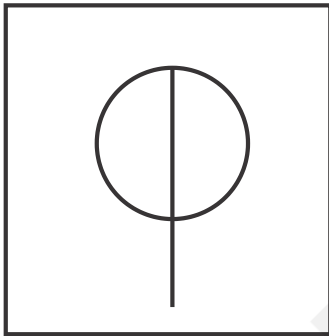

**Option 1:**

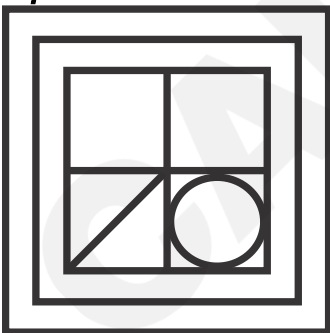

*Option 2:*

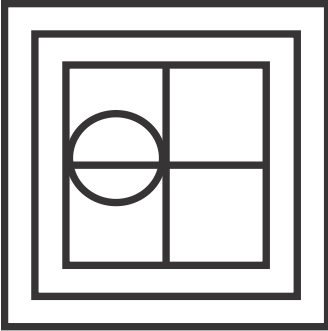

*Option 3:*

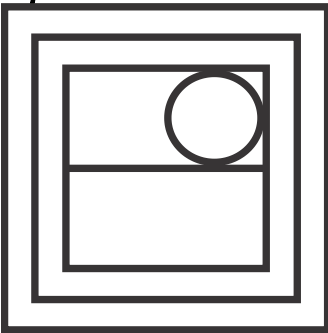

*Option 4:*

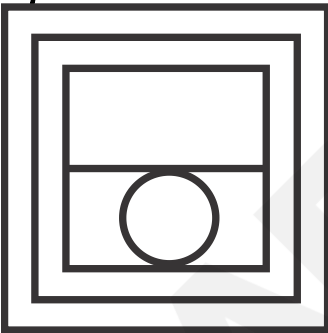

*Correct Answer:*

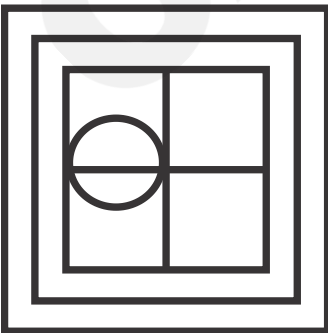

**Solution:**

Because there is no restriction on the rotation of the figure, we will check all the possible angles where the question figure can fit itself in the given option figures.

By comparison of all the option figures, the given question figure is embedded only in the second option figure.

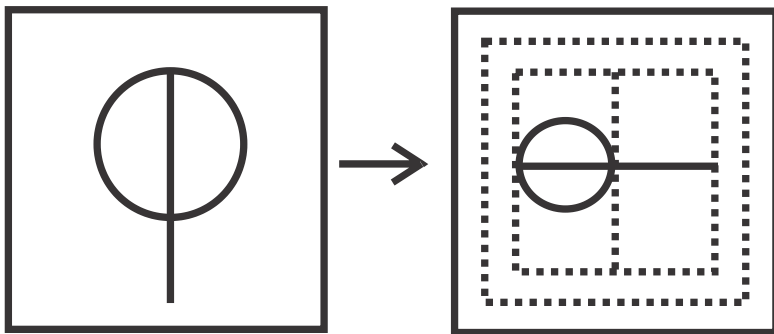

Hence, the **second option** is correct.

**Q.**  
**107**

**Directions:** From the given answer figures, select the one in which the question figure is hidden/embedded.

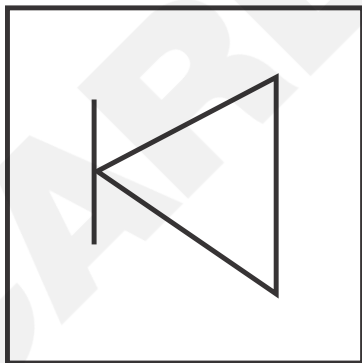

*Option 1:*

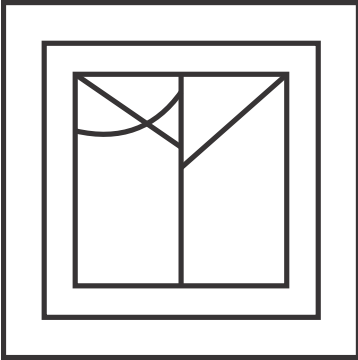

*Option 2:*

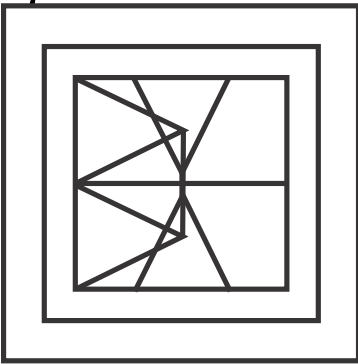

*Option 3:*

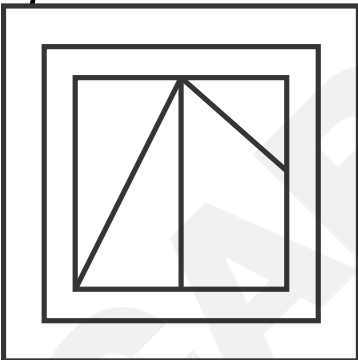

**Option 4:**

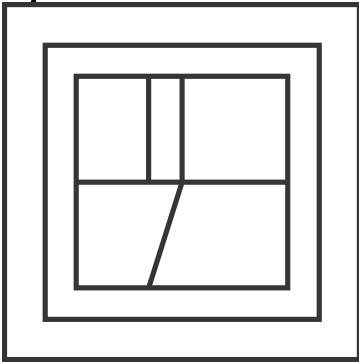

**Correct Answer:**

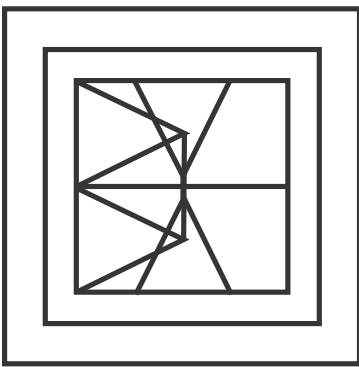

**Solution:**

Because there is no restriction on the rotation of the figure, we will check all the possible angles where the question figure can fit itself in the given option figures.

By comparison of all the option figures, the given question figure is embedded only in the second option figure.

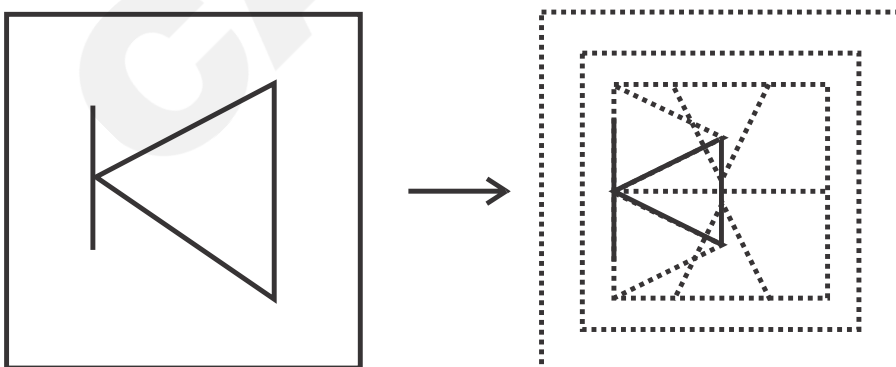

Hence, the **second option** is correct.

Q.  
108

**Directions:** From the given answer figures, select the one in which the question figure is hidden/embedded.

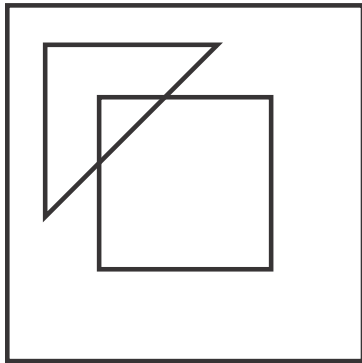

*Option 1:*

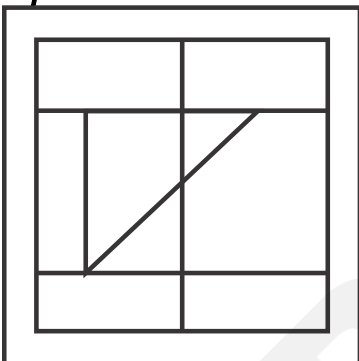

*Option 2:*

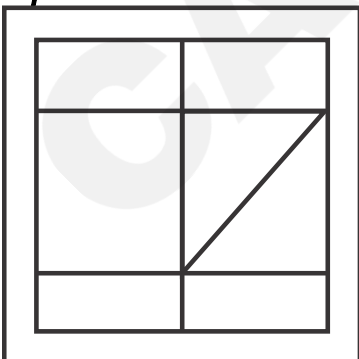

**Option 3:**

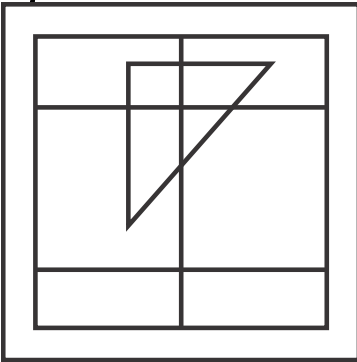

**Option 4:**

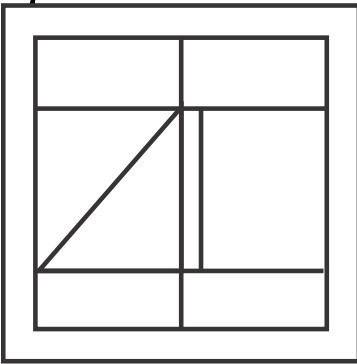

**Correct Answer:**

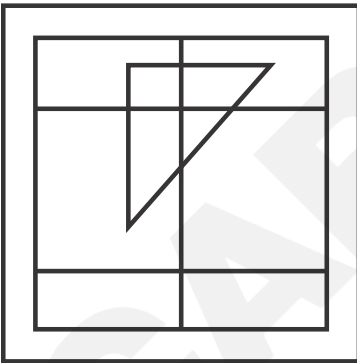

**Solution:**

Because there is no restriction on the rotation of the figure, we will check all the possible angles where the question figure can fit itself in the given option figures.

By comparison of all the option figures, the given question figure is embedded only in the third option figure.

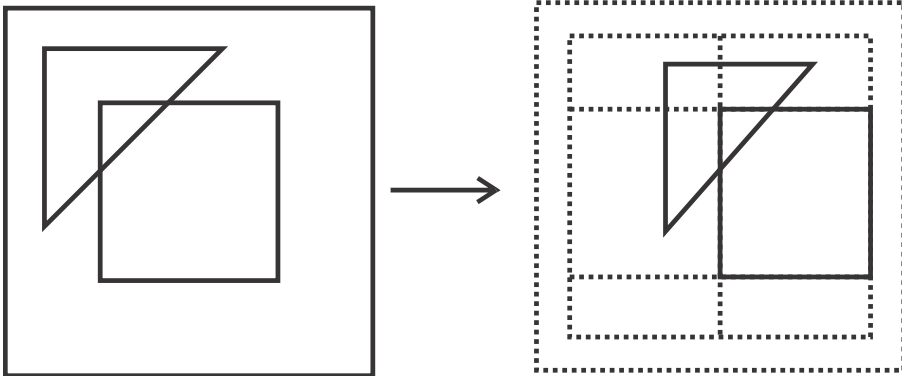

Hence, the **third option** is correct.

**Q.**  
**109**

**Directions:** From the given answer figures, select the one in which the question figure is hidden/embedded.

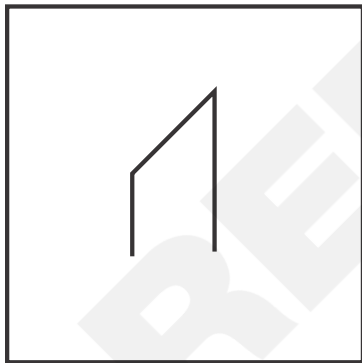

**Option 1:**

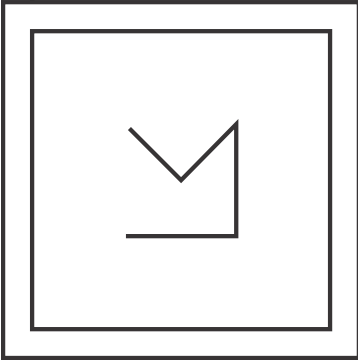

**Option 2:**

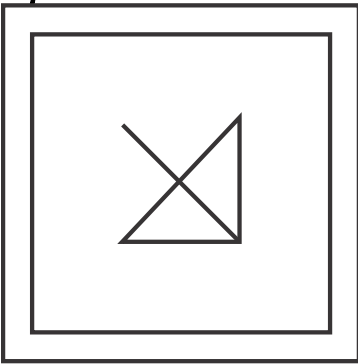

**Option 3:**

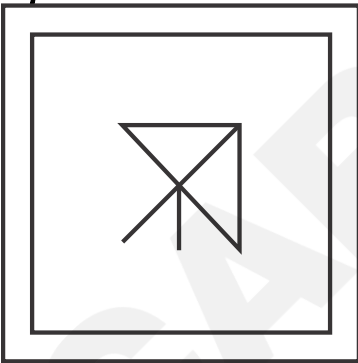

**Option 4:**



**Correct Answer:**

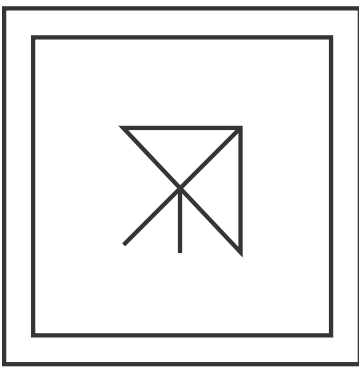

**Solution:**

Because there is no restriction on the rotation of the figure, we will check all the possible angles where the question figure can fit itself in the given option figures.

By comparison of all the option figures, the given question figure is embedded only in the third option figure.

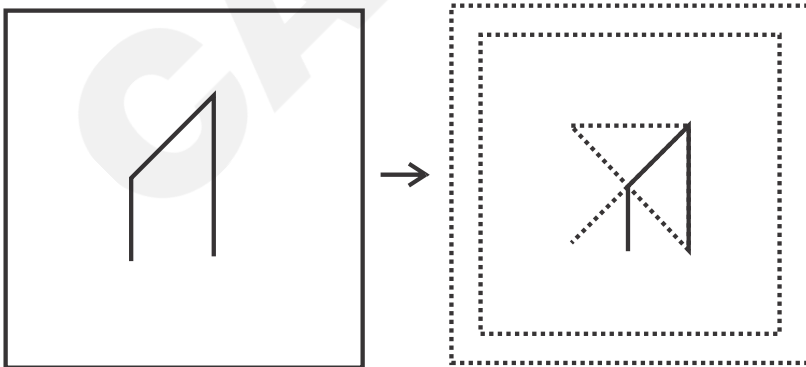

Hence, the **third option** is correct.

Q.  
110

**Directions:** From the given answer figures, select the one in which the question figure is hidden/embedded.

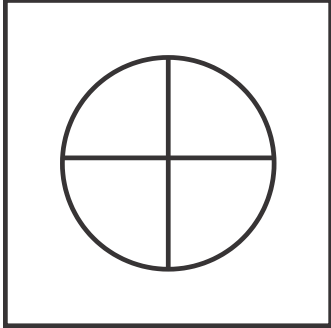

*Option 1:*

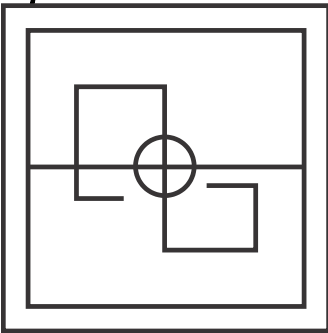

*Option 2:*

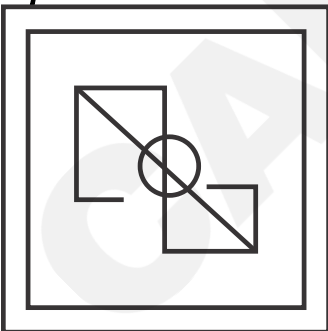

**Option 3:**

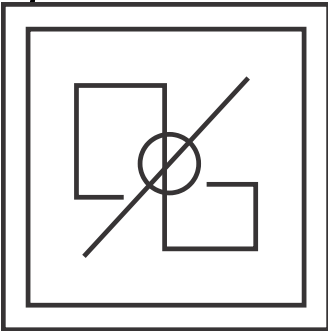

**Option 4:**

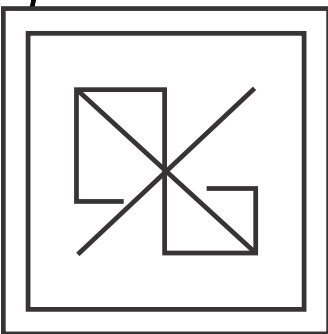

**Correct Answer:**

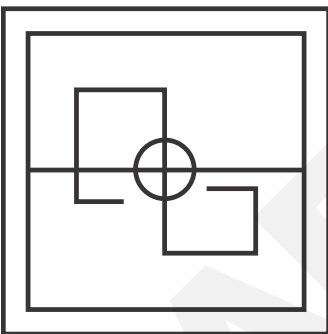

**Solution:**

Because there is no restriction on the rotation of the figure, we will check all the possible angles where the question figure can fit itself in the given option figures.

By comparison of all the option figures, the given question figure is embedded only in the first option figure.

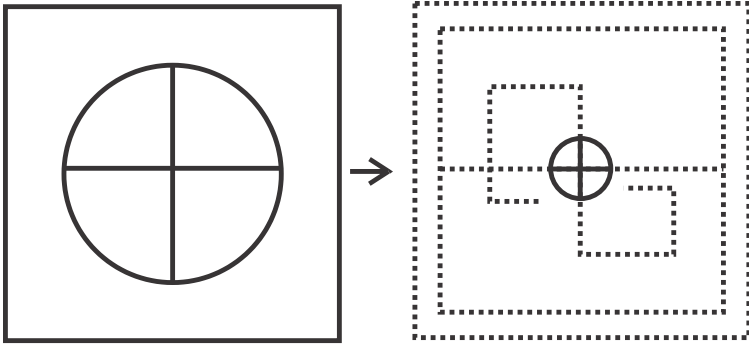

Hence, the **first option** is correct.

**Q.**  
**111**

**Directions:** Select the option in which the given figure is embedded (rotation is NOT allowed).

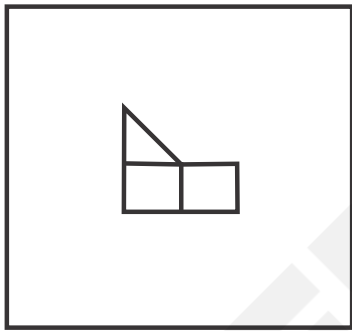

**Option 1:**

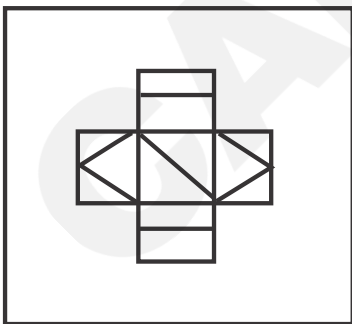

**Option 2:**

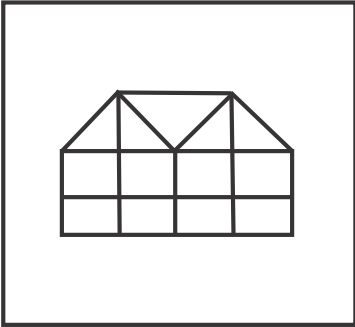

**Option 3:**

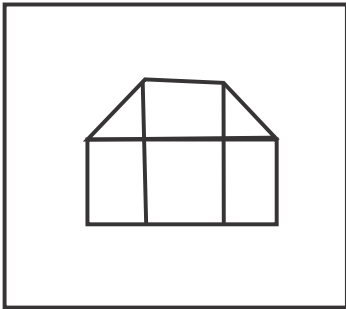

**Option 4:**

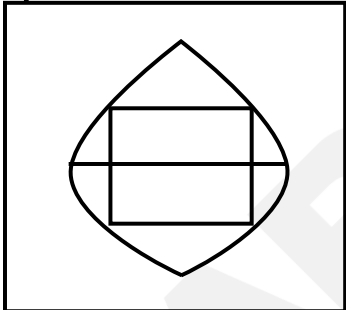

**Correct Answer:**

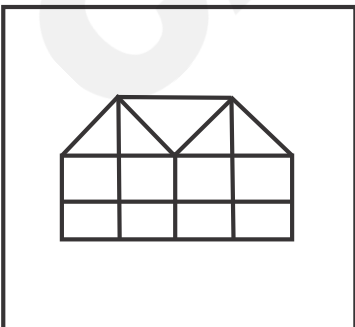

**Solution:**

Since the rotation is restricted. So, the embedded figure will have the same orientation as the main figure. By comparison of all the option figures, the given question figure is embedded only in the second option figure.

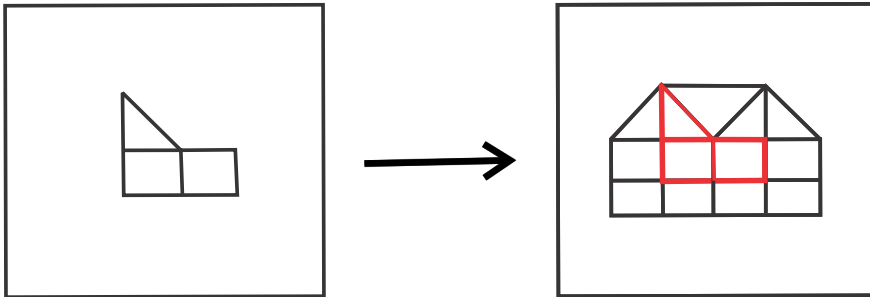

Hence, the **second option** is correct.

**Q.  
112**

**Directions:** Select the option in which the given figure is embedded (rotation is NOT allowed).

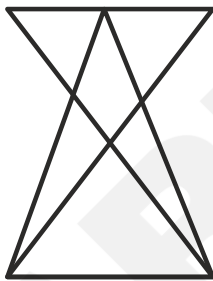

**Option 1:**

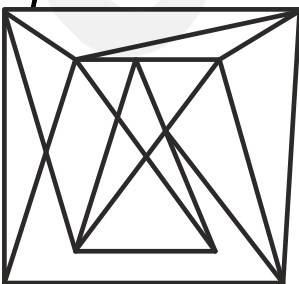

**Option 2:**

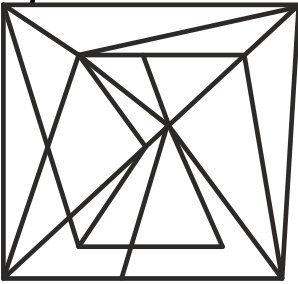

**Option 3:**

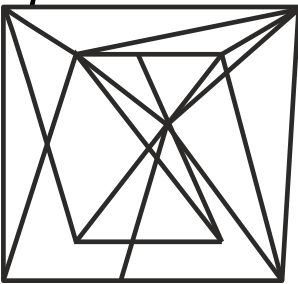

**Option 4:**

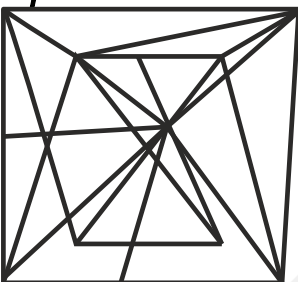

**Correct Answer:**

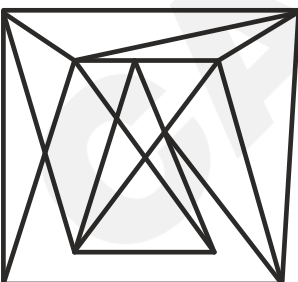

**Solution:**

Since the rotation is restricted. So, the embedded figure will have the same orientation as the main figure. By comparison of all the option figures, the given question figure is embedded only in the

first option figure.

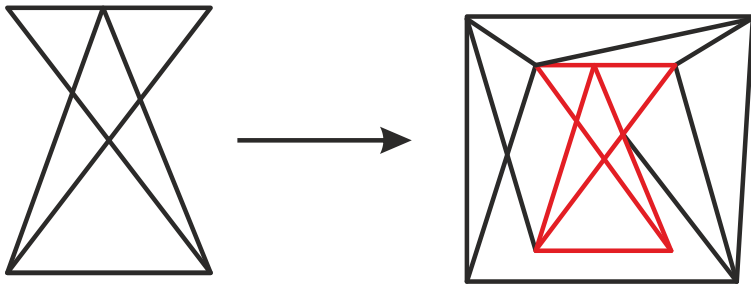

Hence, the **first option** is correct.

**Q.**  
**113**

**Directions:** Select the option in which the given figure is embedded (rotation is NOT allowed).

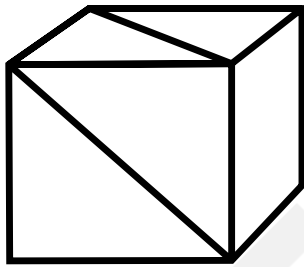

*Option 1:*

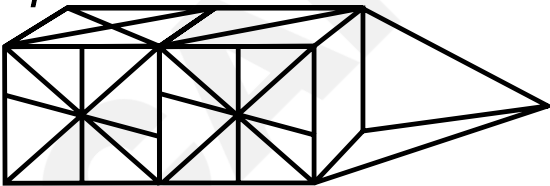

*Option 2:*

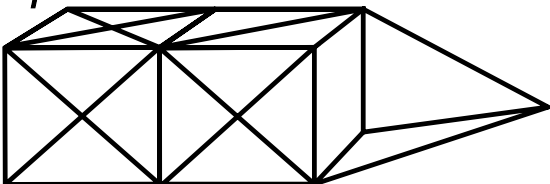

*Option 3:*

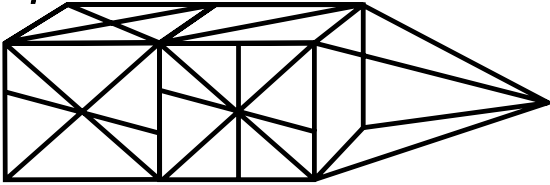

*Option 4:*

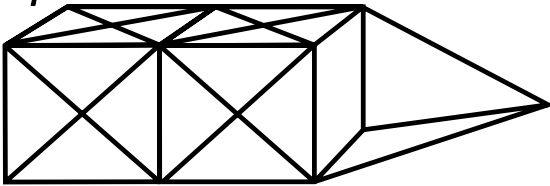

*Correct Answer:*

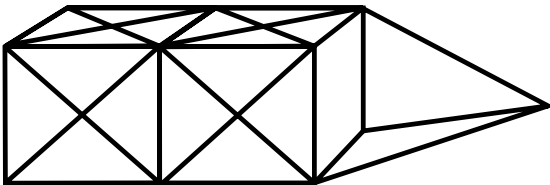

**Solution:**

Since the rotation is restricted. So, the embedded figure will have the same orientation as the main figure. By comparison of all the option figures, the given question figure is embedded only in the fourth option figure.

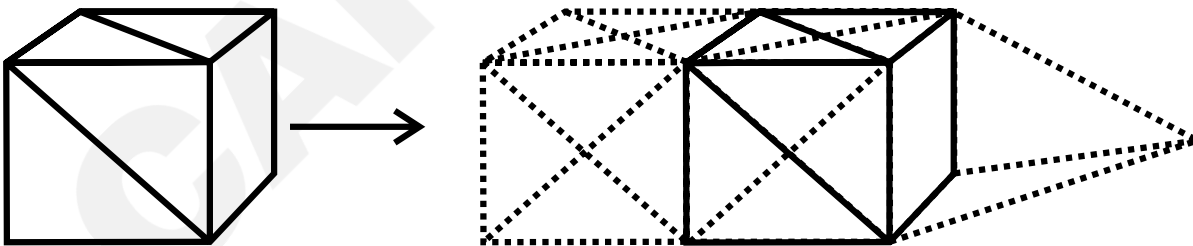

Hence, the **fourth option** is correct.

Q.  
114

**Directions:** Select the option figure in which the given figure (X) is embedded as its part (rotation is NOT allowed).



*Option 1:*

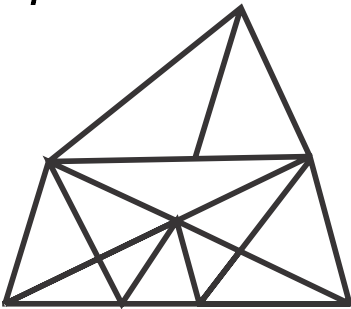

*Option 2:*

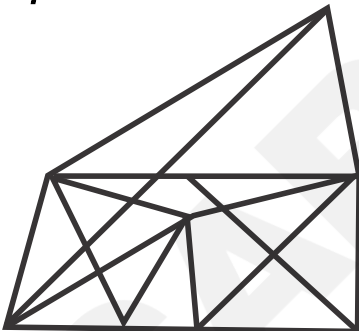

*Option 3:*

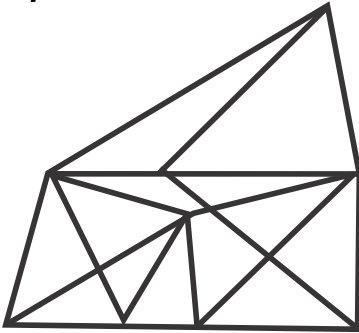

*Option 4:*

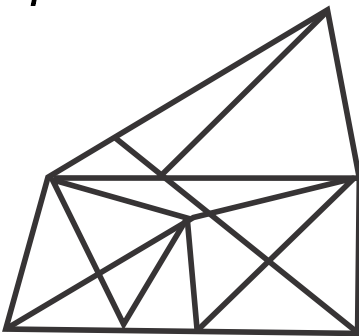

*Correct Answer:*

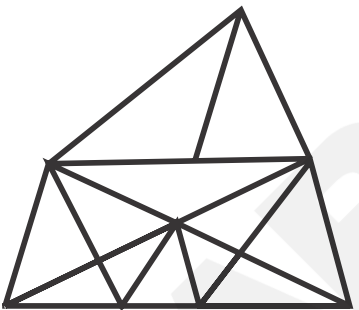

**Solution:**

Since the rotation is restricted. So, the embedded figure will have the same orientation as the main figure. By comparison of all the option figures, the given question figure is embedded only in the first option figure.

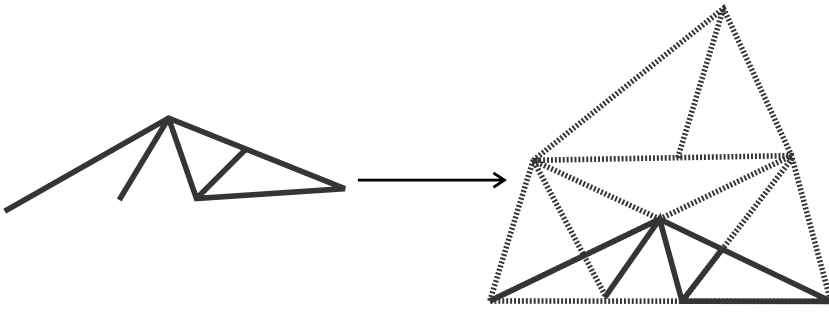

Hence, the **first option** is correct.

Q.  
115

**Directions:** Select the option figure in which the given figure is embedded (rotation is NOT allowed).

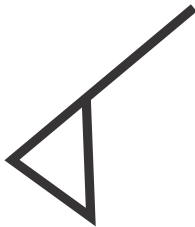

**Option 1:**

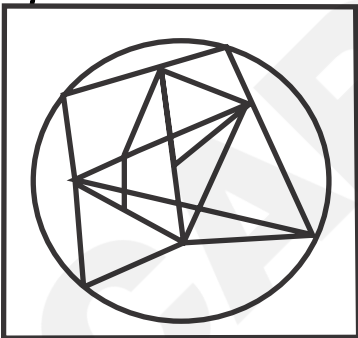

*Option 2:*

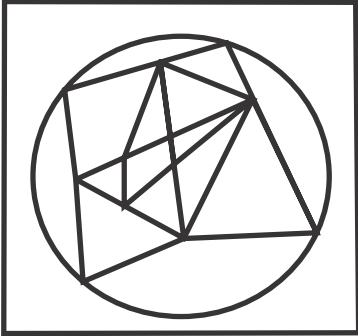

*Option 3:*

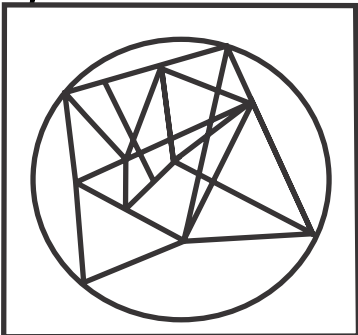

*Option 4:*

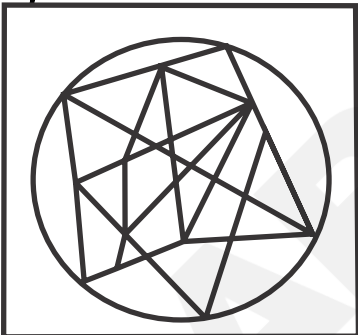

*Correct Answer:*

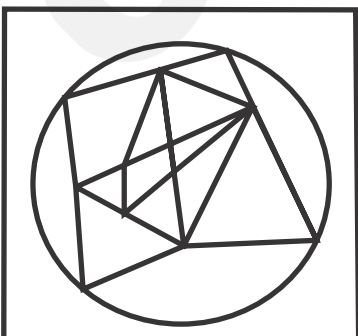

**Solution:**

Since the rotation is restricted. So, the embedded figure will have the same orientation as the main figure. By comparison of all the option figures, the given question figure is embedded only in the second option figure.

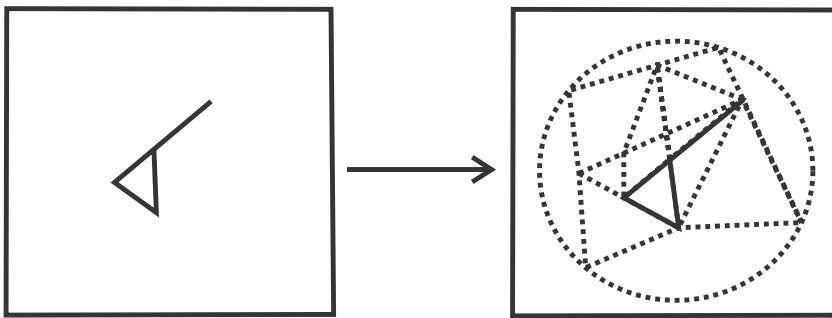

Hence, the **second option** is correct.

**Q.  
116**

**Directions:** Select the option figure in which the given figure X is embedded as its part (rotation is NOT allowed).

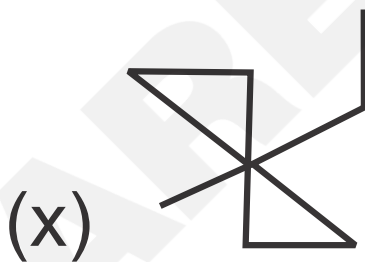

**Option 1:**

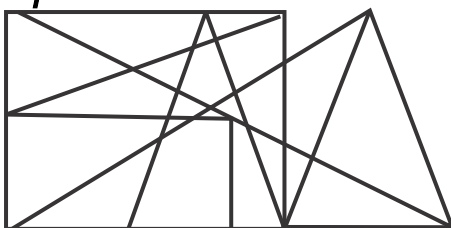

**Option 2:**

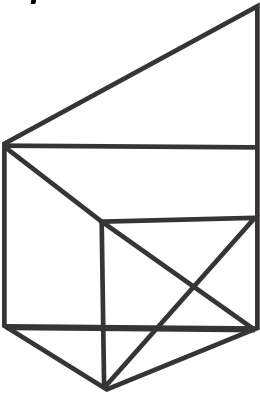

**Option 3:**

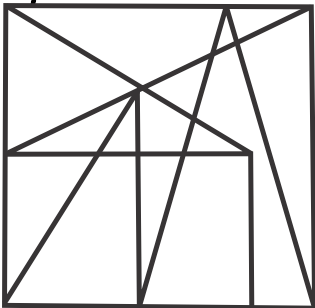

**Option 4:**

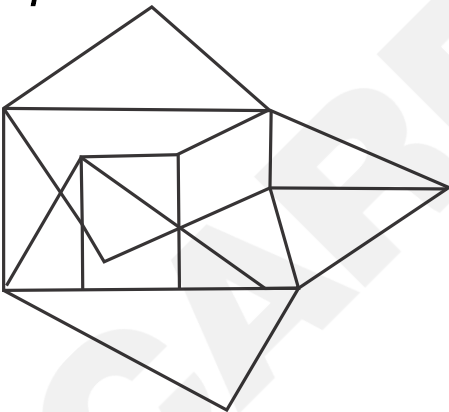

**Correct Answer:**

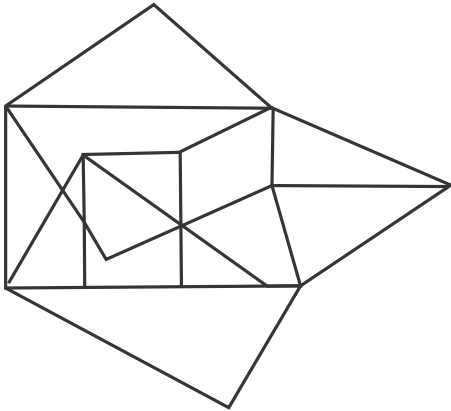

**Solution:**

Since the rotation is restricted. So, the embedded figure will have the same orientation as the main figure. By comparison of all the option figures, the given question figure is embedded only in the fourth option figure.

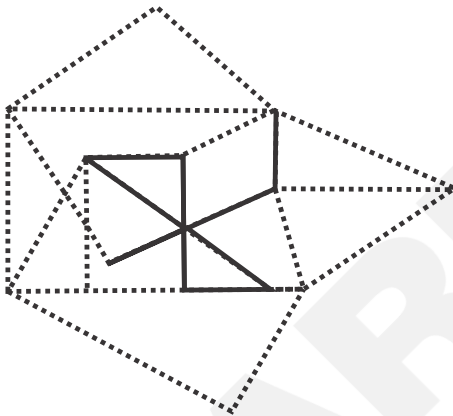

Hence, the **fourth option** is correct.

Q.  
117

**Directions:** Select the option in which the given figure is embedded (rotation is NOT allowed).

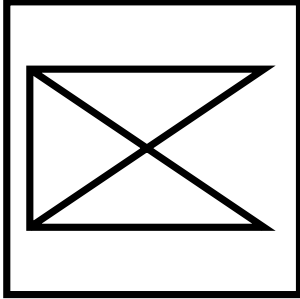

*Option 1:*

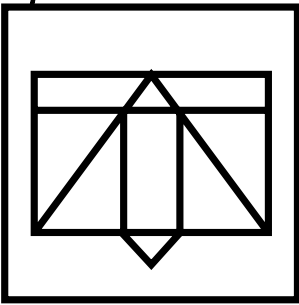

*Option 2:*

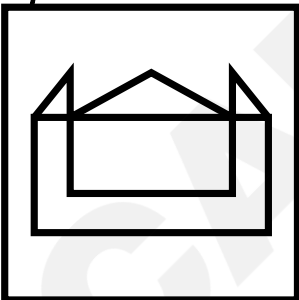

*Option 3:*

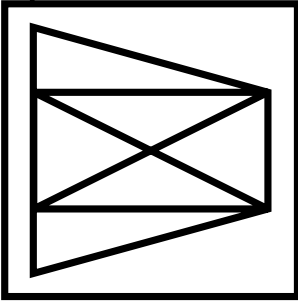

*Option 4:*

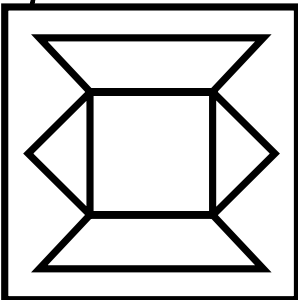

*Correct Answer:*

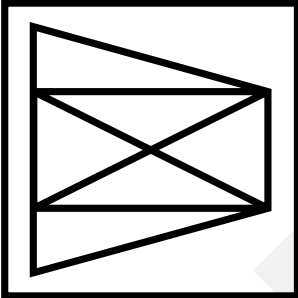

**Solution:**

Since the rotation is restricted. So, the embedded figure will have the same orientation as the main figure. By comparison of all the option figures, the given question figure is embedded only in the third option figure.

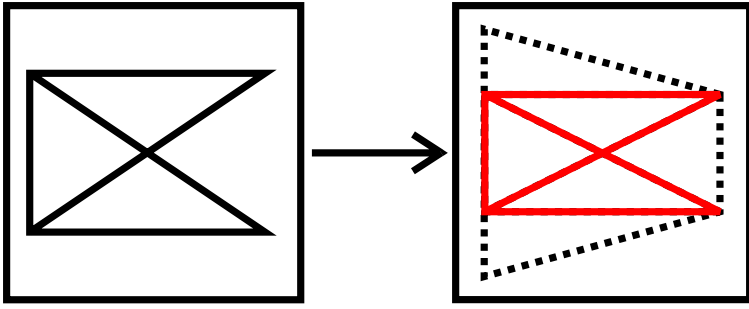

Hence, the **third option** is correct.

**Q.**  
**118**

**Directions:** Select the option figure in which the given figure is embedded (rotation is NOT allowed).

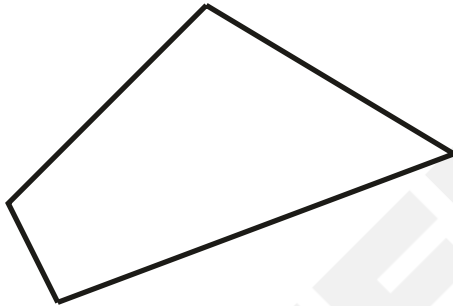

**Option 1:**

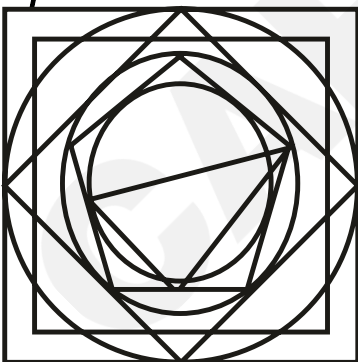

*Option 2:*

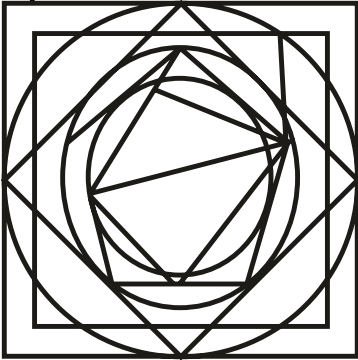

*Option 3:*

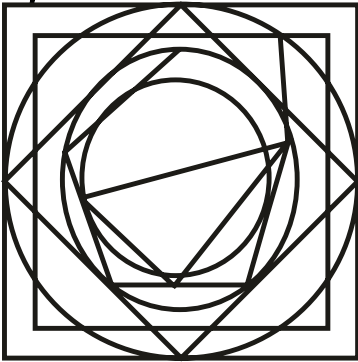

*Option 4:*

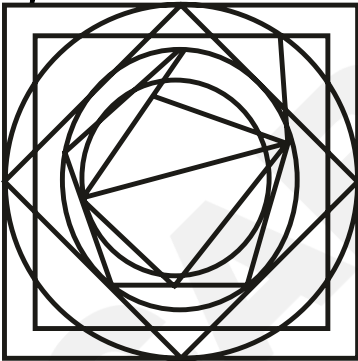

**Correct Answer:**

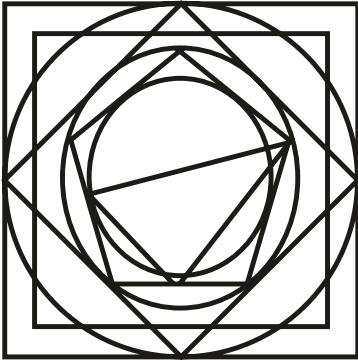

**Solution:**

Since the rotation is restricted. So, the embedded figure will have the same orientation as the main figure. By comparison of all the option figures, the given question figure is embedded only in the first option figure.

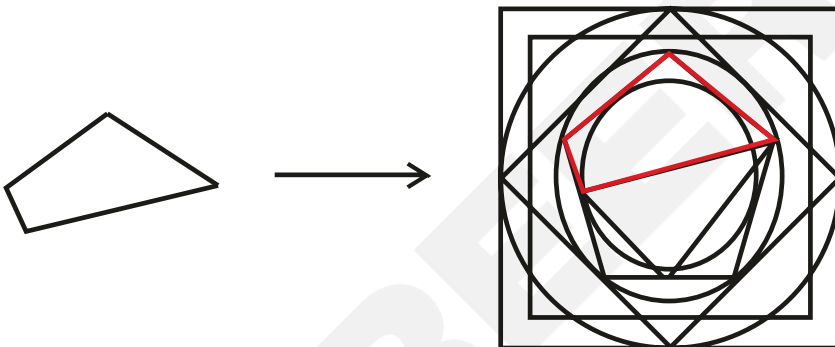

Hence, the **first option** is correct.

Q.  
119

**Directions:** Select the option figure in which the given figure (X) is embedded as its part (rotation is NOT allowed).

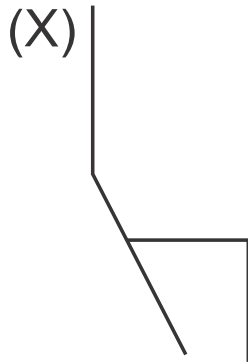

**Option 1:**

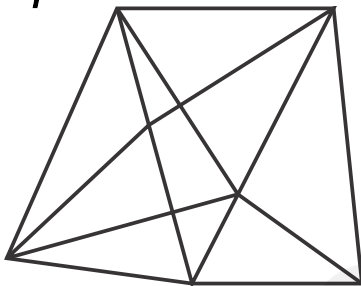

**Option 2:**

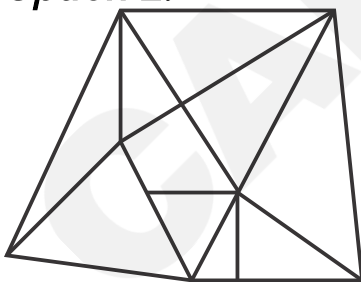

**Option 3:**

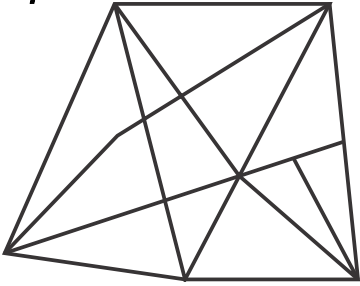

**Option 4:**

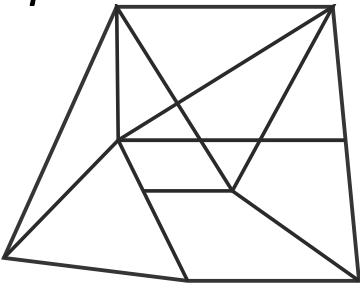

**Correct Answer:**

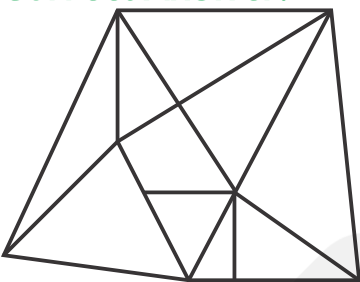

**Solution:**

Since the rotation is restricted. So, the embedded figure will have the same orientation as the main figure. By comparison of the question figure with all the option figures, the given question figure is embedded only in the second option figure.

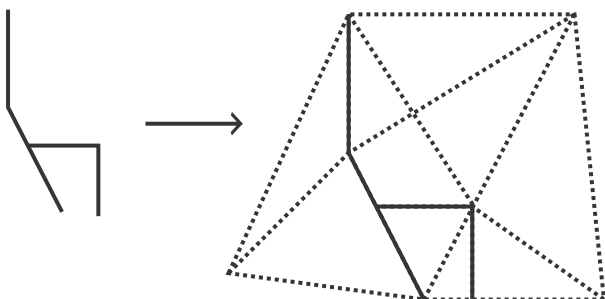

Hence, the **second option** is correct.

**Q.**  
**120**

**Directions:** Select the option in which the given figure is embedded (rotation is NOT allowed).

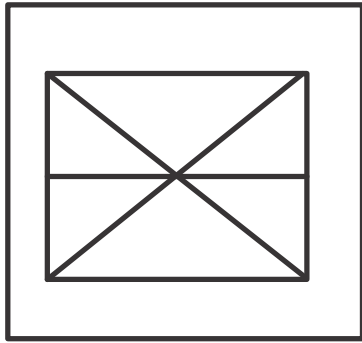

*Option 1:*

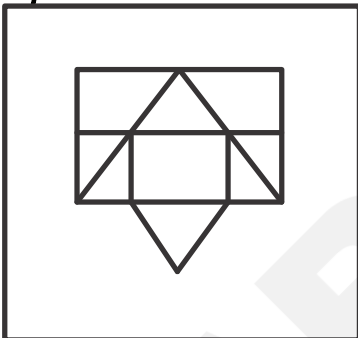

*Option 2:*

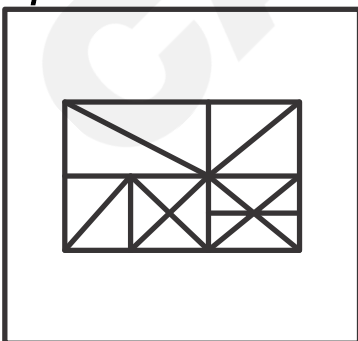

**Option 3:**

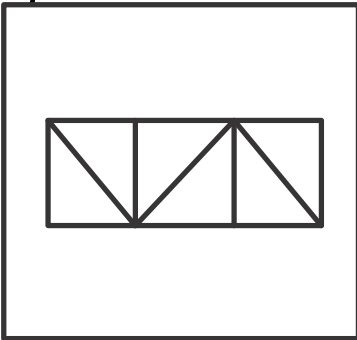

**Option 4:**

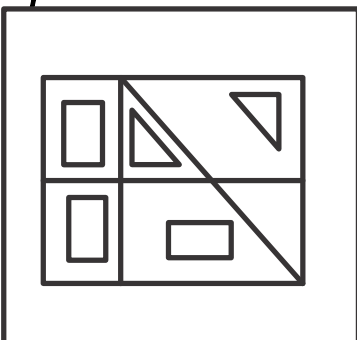

**Correct Answer:**

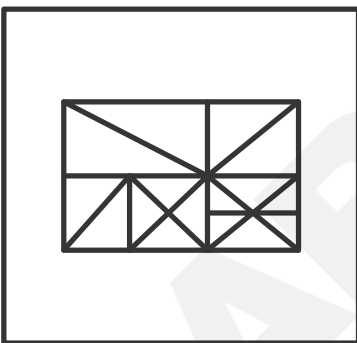

**Solution:**

Since the rotation is restricted. So, the embedded figure will have the same orientation as the main figure. By comparison of the question figure with all the option figures, the given question figure is embedded only in the second option figure.

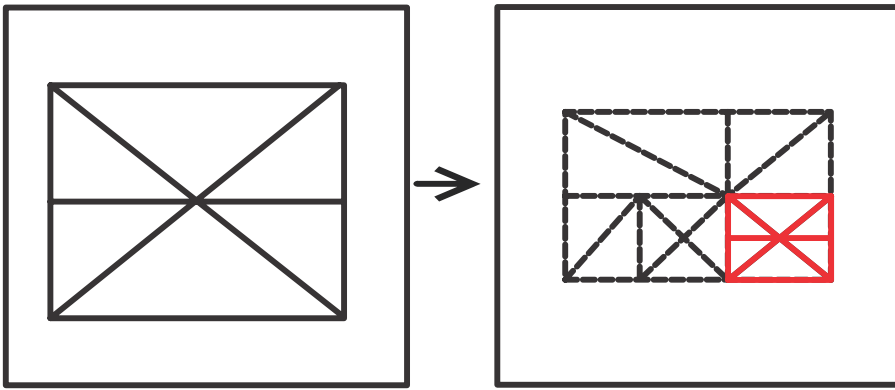

Hence, the **second option** is correct.

**Q.  
121**

**Directions:** Select the option in which the given figure is embedded. (Rotation is NOT allowed)

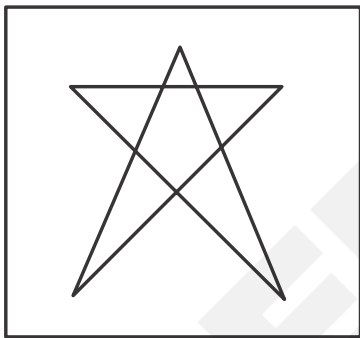

**Option 1:**

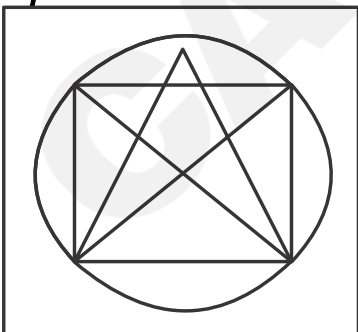

**Option 2:**

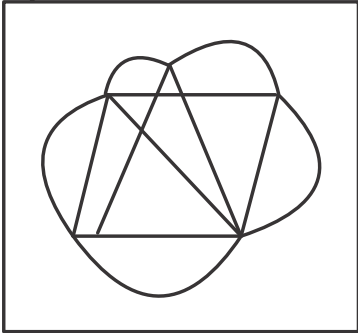

**Option 3:**

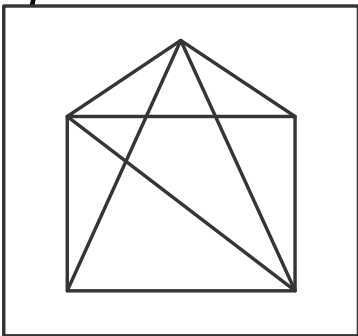

**Option 4:**

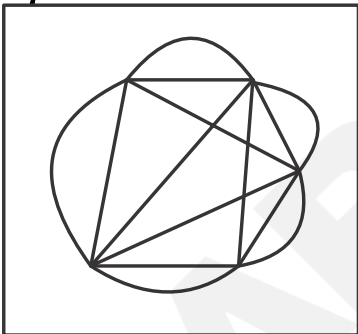

**Correct Answer:**

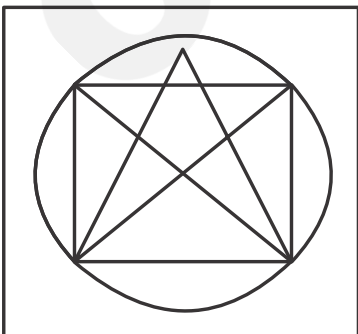

**Solution:**

Since the rotation is restricted. So, the embedded figure will have the same orientation as the main figure. By comparison of the question figure with all the option figures, the given question figure is embedded only in the first option figure.

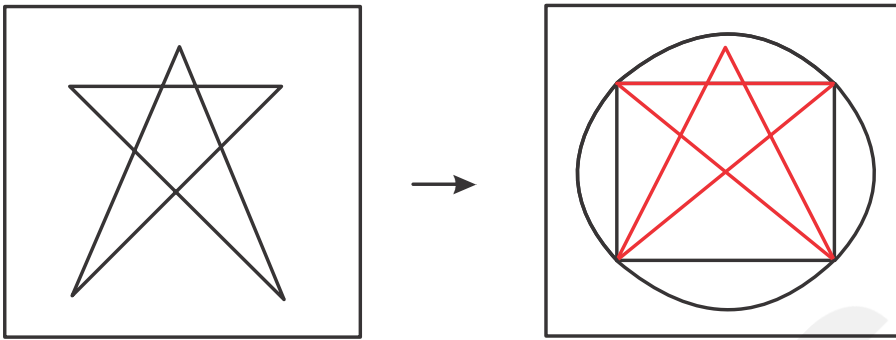

Hence, the **first option** is correct.

**Q.  
122**

**Directions:** Select the option figure in which the given figure (X) is embedded as its part (rotation is NOT allowed).

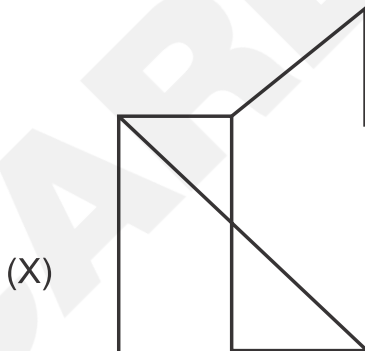

**Option 1:**

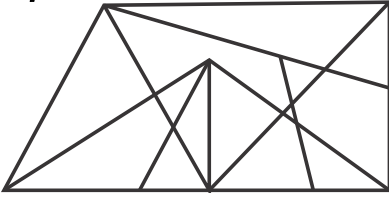

**Option 2:**

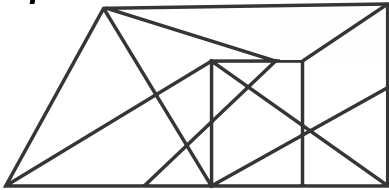

**Option 3:**

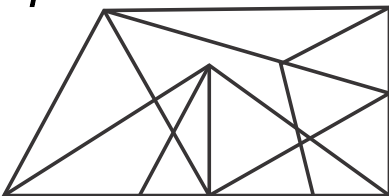

**Option 4:**

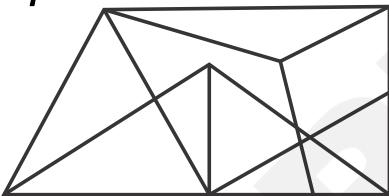

**Correct Answer:**

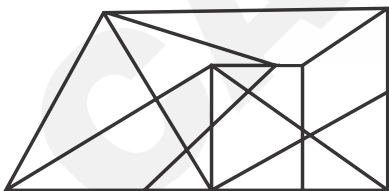

**Solution:**

Since the rotation is restricted. So, the embedded figure will have the same orientation as the main figure. By comparison of the question figure with all the option figures, the given question figure

is embedded only in the second option figure.

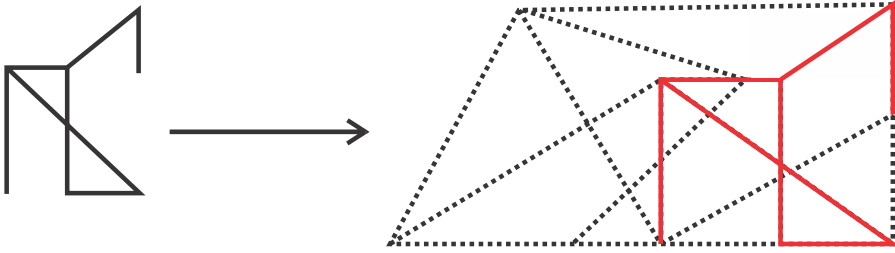

Hence, the **second option** is correct.

**Q.**  
**123**

**Directions:** Select the option figure in which the given figure (X) is embedded as its part (rotation is NOT allowed).

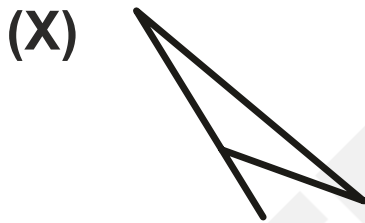

**Option 1:**

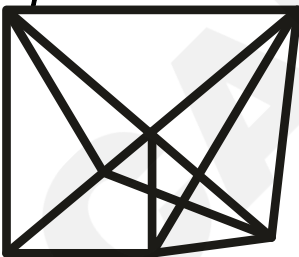

*Option 2:*

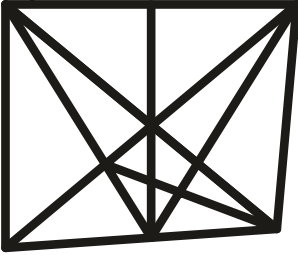

*Option 3:*

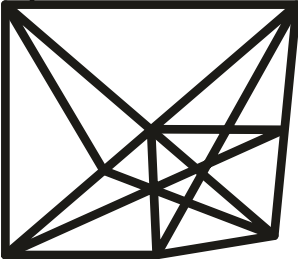

*Option 4:*

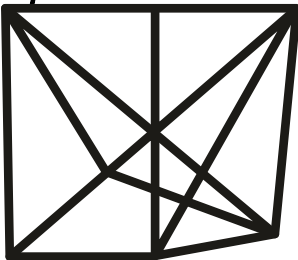

*Correct Answer:*

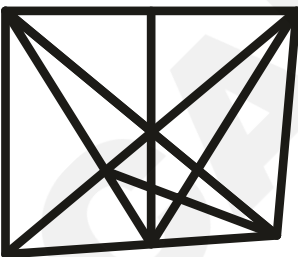

**Solution:**

Since the rotation is restricted. So, the embedded figure will have the same orientation as the main figure. By comparison of the question figure with all the option figures, the given question figure is embedded only in the second option figure.

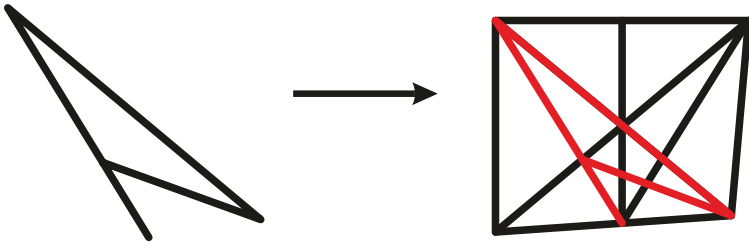

Hence, the **second option** is correct.

**Q.  
124**

**Directions:** Select the option figure in which the given figure (X) is embedded as its part (rotation is NOT allowed).

**(X)**

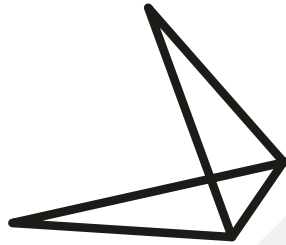

**Option 1:**

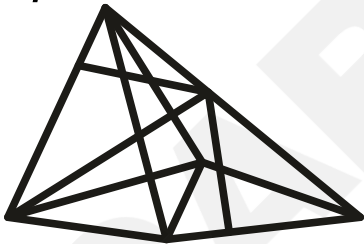

**Option 2:**

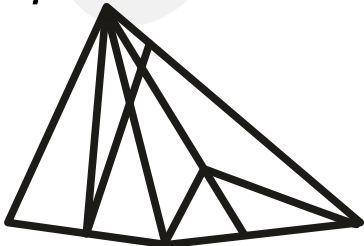

Option 3:

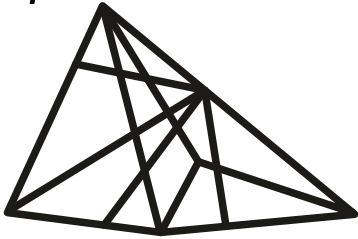

Option 4:

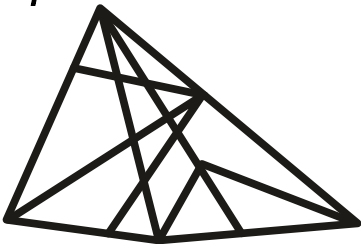

Correct Answer:

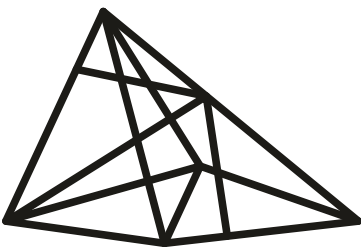

**Solution:**

Since the rotation is restricted. So, the embedded figure will have the same orientation as the main figure. By comparison of the question figure with all the option figures, the given question figure is embedded only in the first option figure.

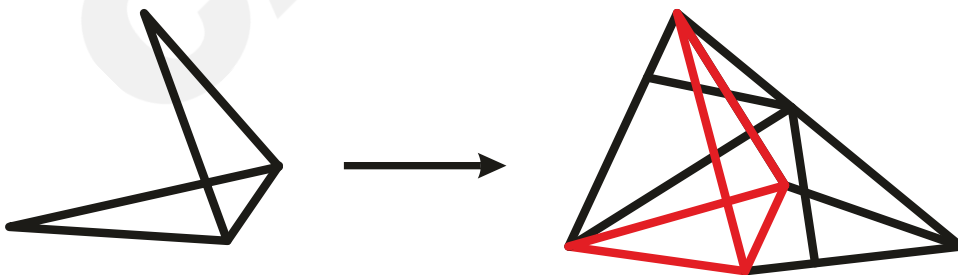

Hence, the **first option** is correct.

Q.  
125

**Directions:** Select the option figure in which the given figure is embedded as its part (rotation is NOT allowed).

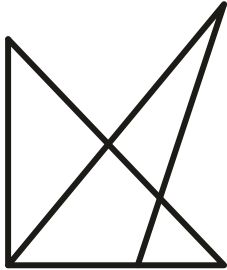

Option 1:

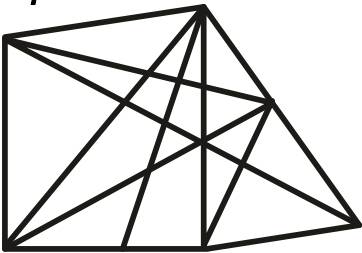

Option 2:

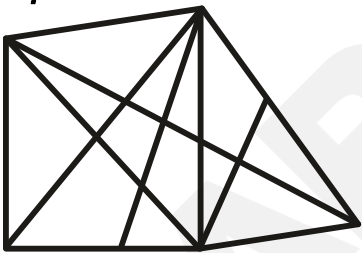

Option 3:

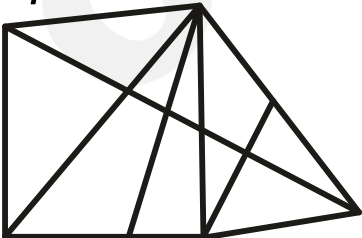

**Option 4:**

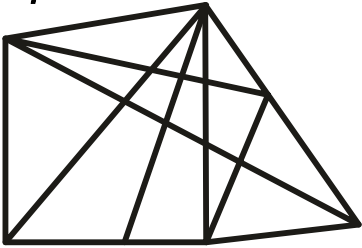

**Correct Answer:**

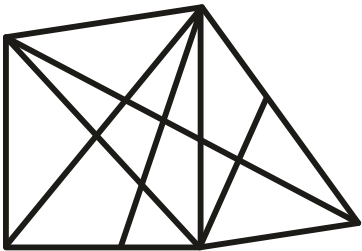

**Solution:**

Since the rotation is restricted. So, the embedded figure will have the same orientation as the main figure. By comparison of the question figure with all the option figures, the given question figure is embedded only in the second option figure.

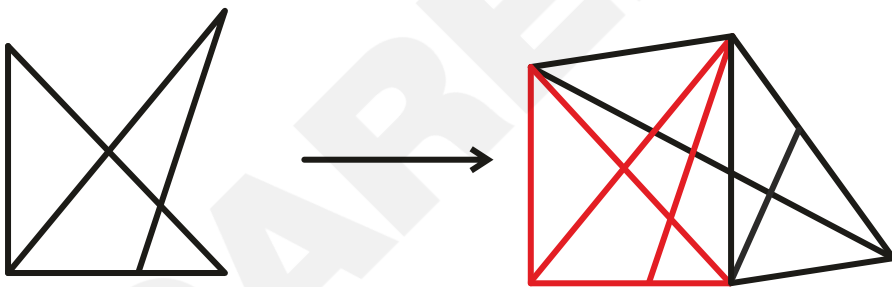

Hence, the **second option** is correct.

Q.  
126

**Directions:** Select the option figure in which the given figure is embedded as its part (rotation is NOT allowed).

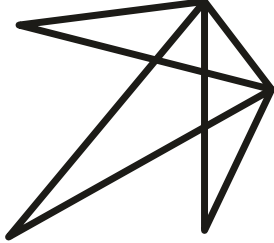

*Option 1:*

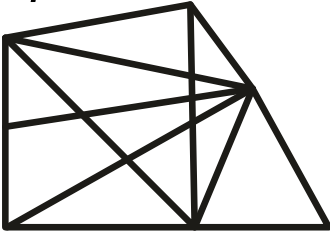

*Option 2:*

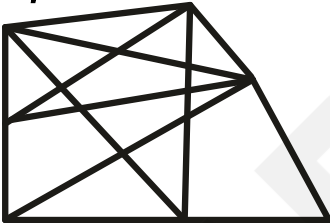

*Option 3:*

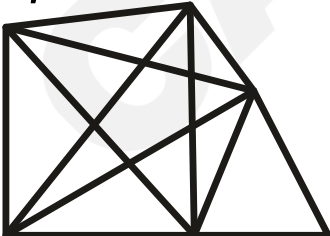

**Option 4:**

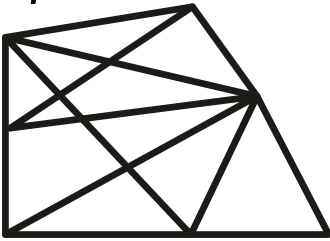

**Correct Answer:**

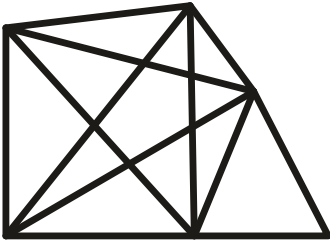

**Solution:**

Since the rotation is restricted. So, the embedded figure will have the same orientation as the main figure. By comparison of all the option figures, the given question figure is embedded only in the third option figure.

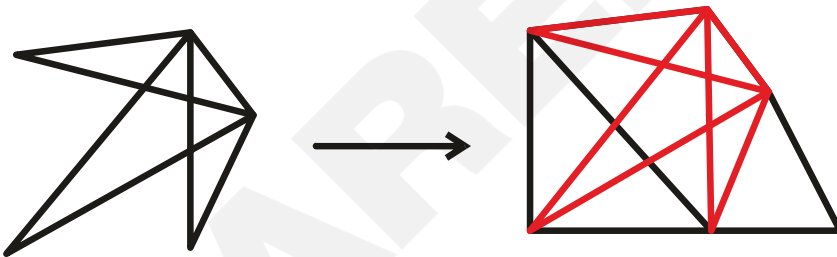

Hence, the **third option** is correct.

Q.  
127

**Directions:** Select the option figure in which the given figure is embedded as its part (rotation is NOT allowed).

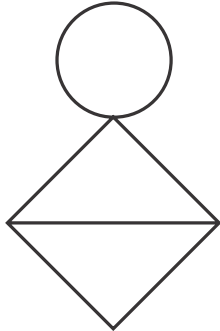

Option 1:

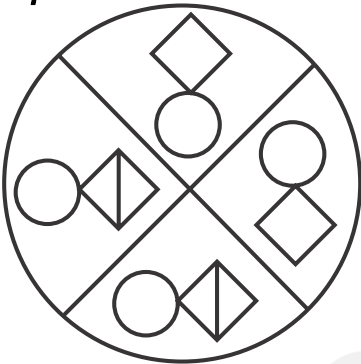

Option 2:

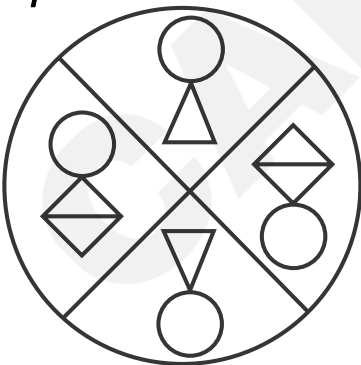

**Option 3:**

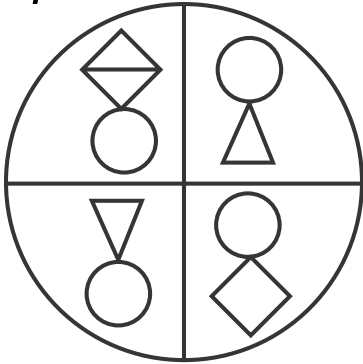

**Option 4:**

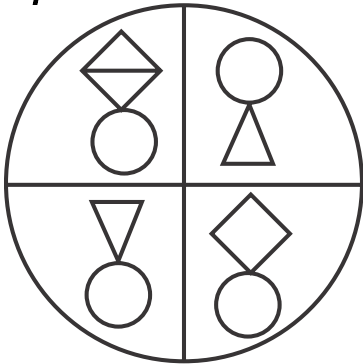

**Correct Answer:**

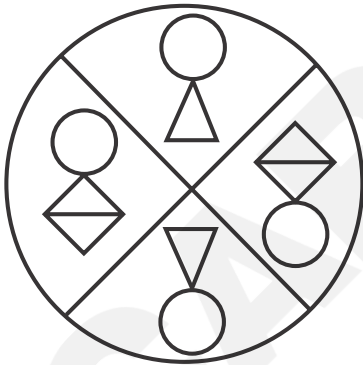

**Solution:**

Since the rotation is restricted. So, the embedded figure will have the same orientation as the main figure. By comparison of the question figure with all the option figures, the given question figure is embedded only in the second option figure.

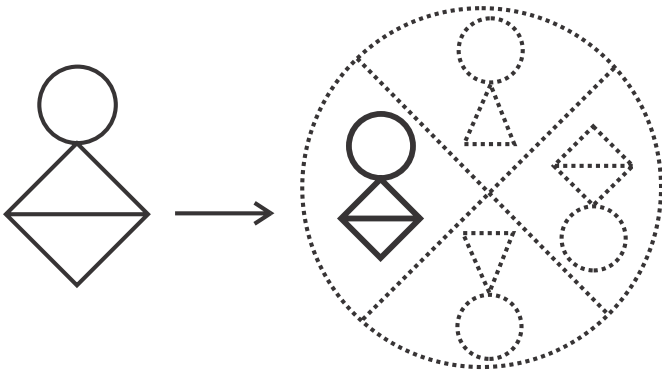

Hence, the **second option** is correct.

**Q.  
128**

**Directions:** Select the option in which the given figure is embedded (rotation is NOT allowed).

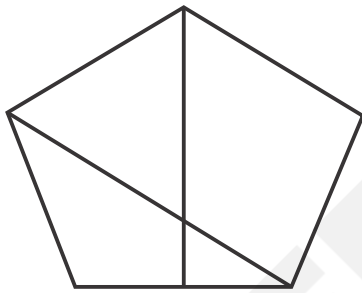

**Option 1:**

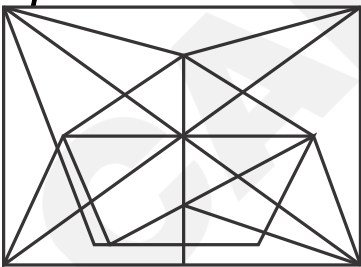

**Option 2:**

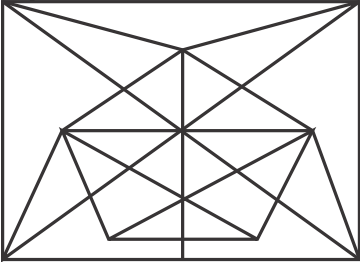

**Option 3:**

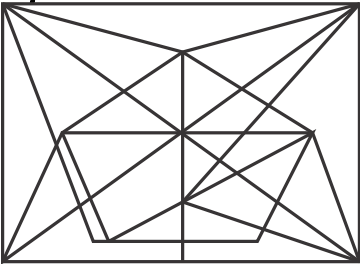

**Option 4:**

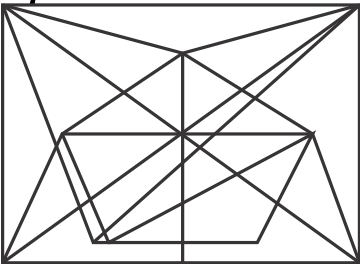

**Correct Answer:**

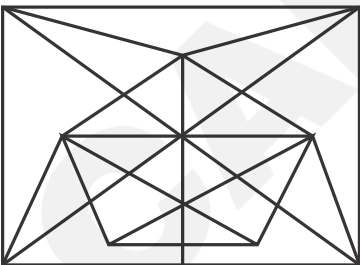

**Solution:**

Since the rotation is restricted. So, the embedded figure will have the same orientation as the main figure. By comparison of the question figure with all the option figures, the given question figure is embedded only in the second option figure.

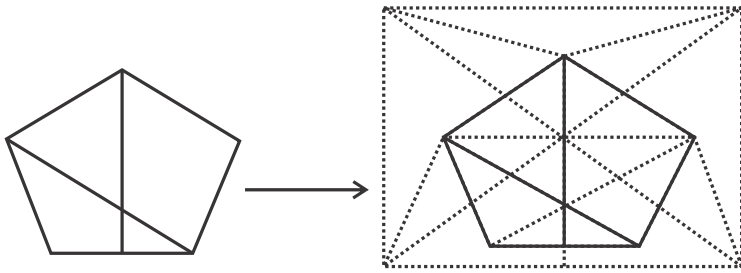

Hence, the **second option** is correct.

**Q.  
129**

**Directions:** Select the option figure in which the given figure (X) is embedded as its part (rotation is NOT allowed).

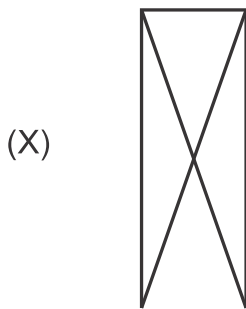

**Option 1:**



**Option 2:**

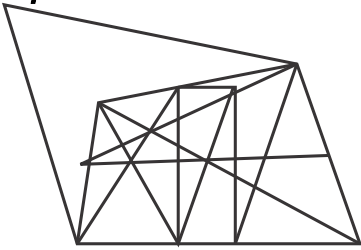

**Option 3:**

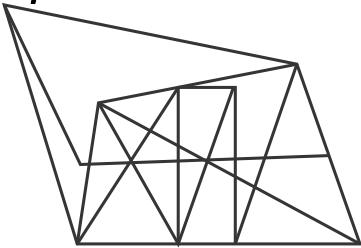

**Option 4:**

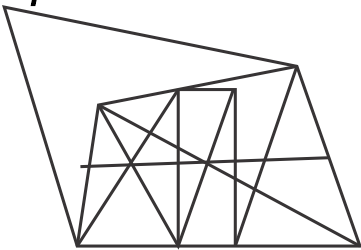

**Correct Answer:**



**Solution:**

Since the rotation is restricted. So, the embedded figure will have the same orientation as the main figure. By comparison of the question figure with all the option figures, the given question figure is embedded only in the first option figure.

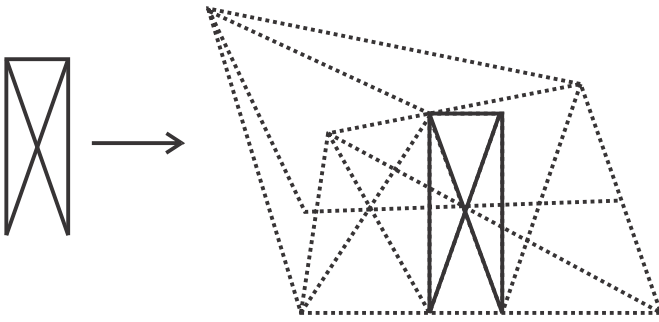

Hence, the **first option** is correct.

**Q.  
130**

**Directions:** Select the option figure in which the given figure (X) is embedded as its part (rotation is NOT allowed).

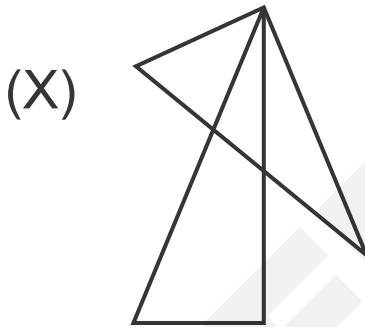

**Option 1:**

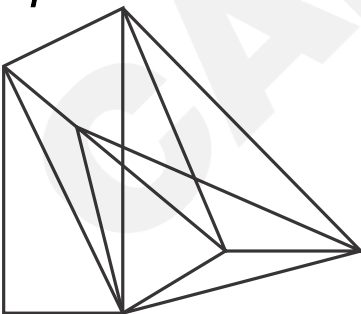

**Option 2:**

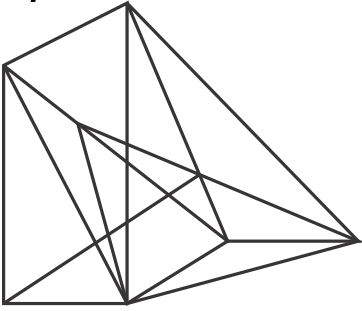

**Option 3:**

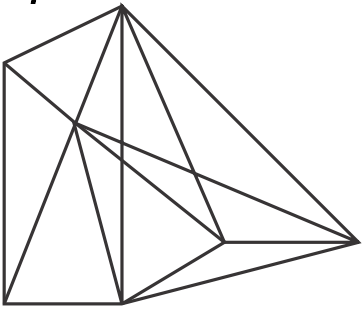

**Option 4:**

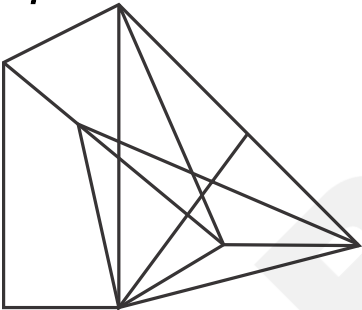

**Correct Answer:**

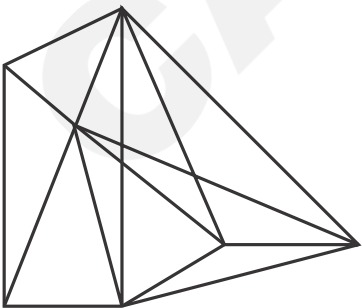

**Solution:**

Since the rotation is restricted. So, the embedded figure will have the same orientation as the main figure. By comparison of the question figure with all the option figures, the given question figure is embedded only in the third option figure.

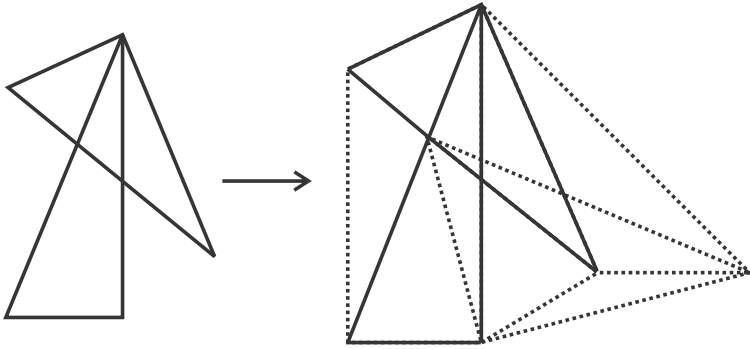

Hence, the **third option** is correct.

**Q.**  
**131**

**Directions:** Select the option in which the given figure is embedded (rotation is NOT allowed).

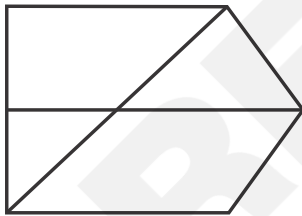

**Option 1:**

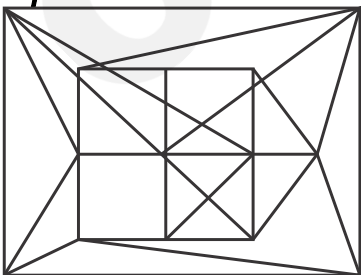

**Option 2:**

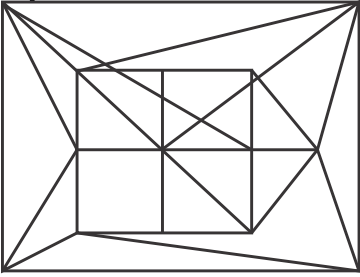

**Option 3:**

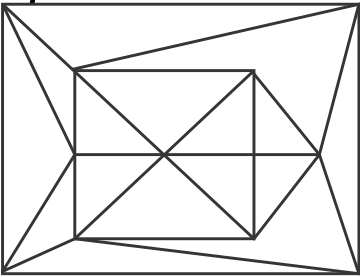

**Option 4:**

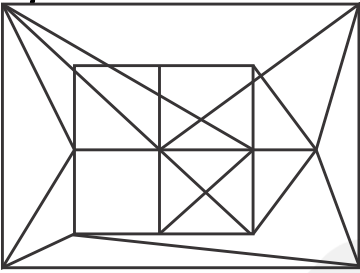

**Correct Answer:**

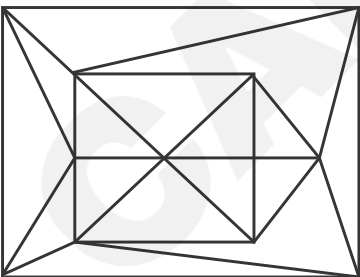

**Solution:**

Since the rotation is restricted. So, the embedded figure will have the same orientation as the main figure. By comparison of the question figure with all the option figures, the given question figure

is embedded only in the third option figure.

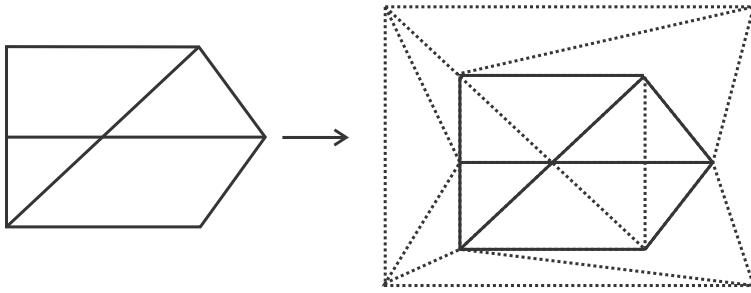

Hence, the **third option** is correct.

**Q.**  
**132**

**Directions:** Select the option figure in which the given figure (X) is embedded as its part (rotation is NOT allowed).

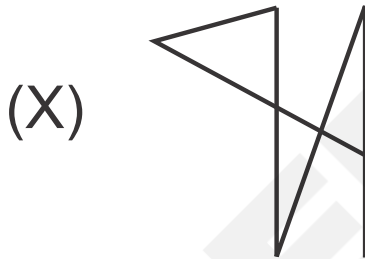

**Option 1:**

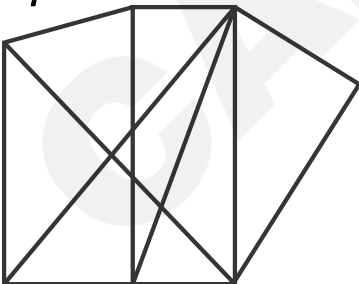



is embedded only in the fourth option figure.

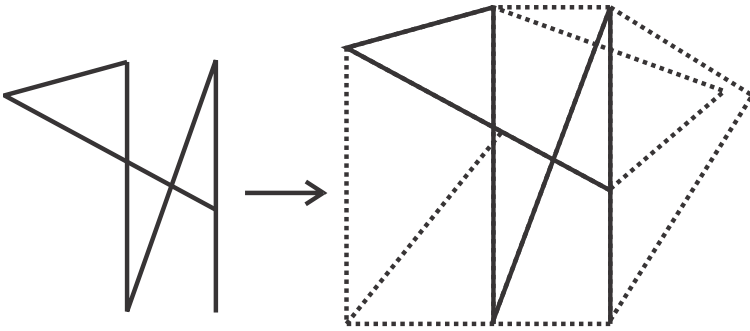

Hence, the **fourth option** is correct.

**Q.  
133**

**Directions:** Select the option figure in which the given figure is embedded (rotation is NOT allowed).

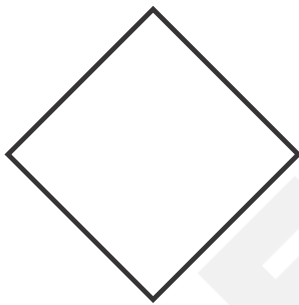

**Option 1:**

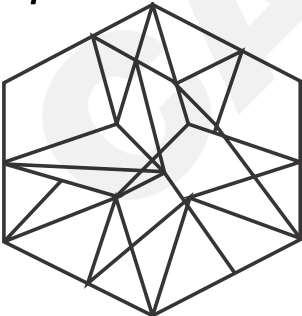

**Option 2:**

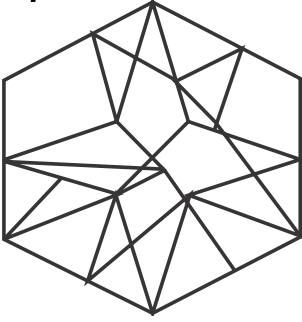

**Option 3:**

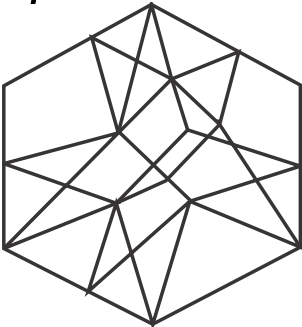

**Option 4:**

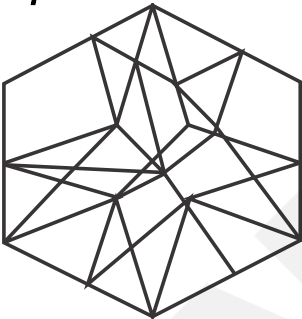

**Correct Answer:**

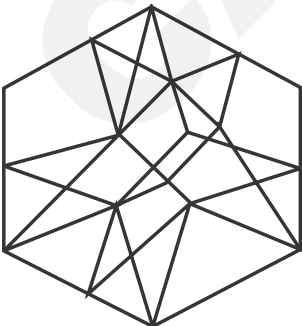

**Solution:**

Since the rotation is restricted. So, the embedded figure will have the same orientation as the main figure. By comparison of the question figure with all the option figures, the given question figure is embedded only in the third option figure.

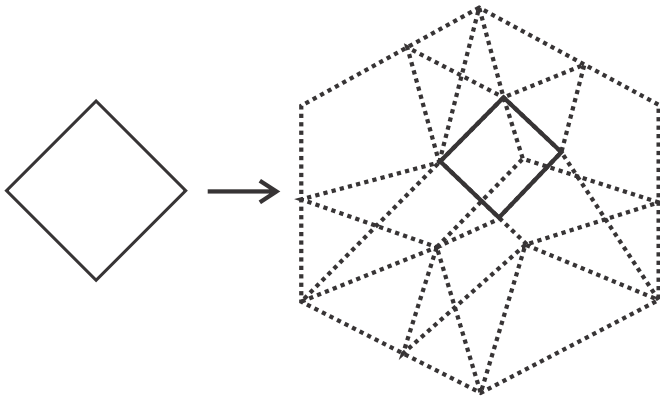

Hence, the **third option** is correct.

**Q.**  
**134**

**Directions:** Select the option figure in which the given figure is embedded. (rotation is NOT allowed)

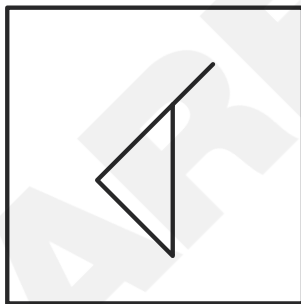

*Option 1:*

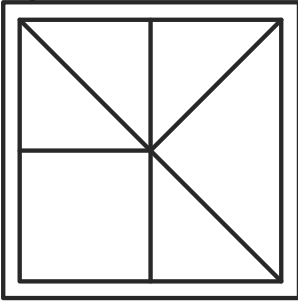

*Option 2:*

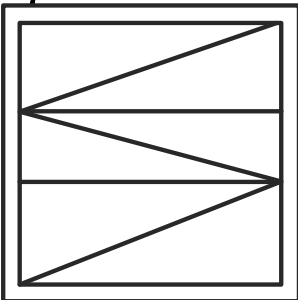

*Option 3:*

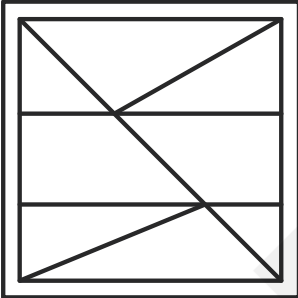

*Option 4:*

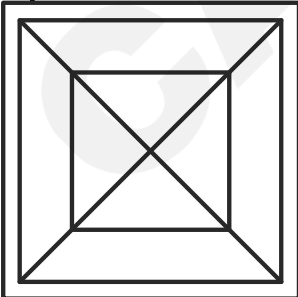

**Correct Answer:**

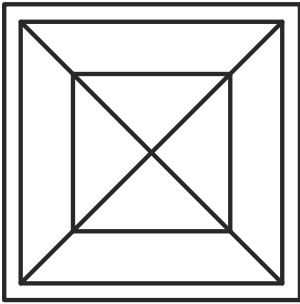

**Solution:**

Since the rotation is restricted. So, the embedded figure will have the same orientation as the main figure. By comparison of the question figure with all the option figures, the given question figure is embedded only in the fourth option figure.

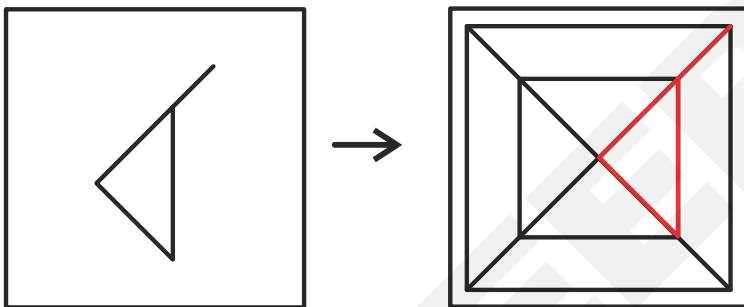

Hence, the **fourth option** is correct.

**Q.  
135**

**Directions:** Select the option figure in which the given figure is embedded. (rotation is NOT allowed)

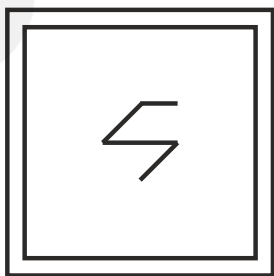

*Option 1:*

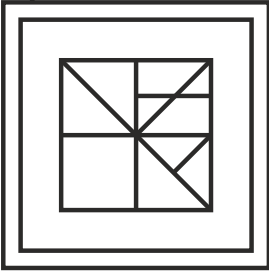

*Option 2:*

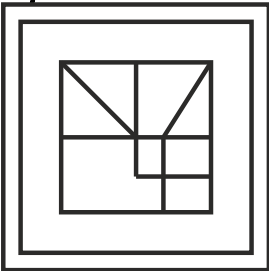

*Option 3:*

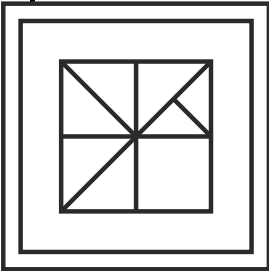

*Option 4:*

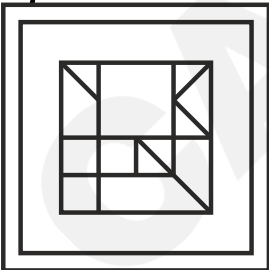

**Correct Answer:**

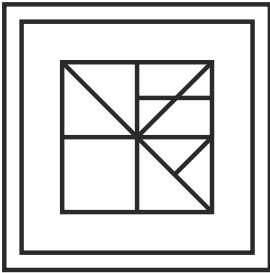

**Solution:**

Since the rotation is restricted. So, the embedded figure will have the same orientation as the main figure. By comparison of all the option figures, the given question figure is embedded only in the first option figure.

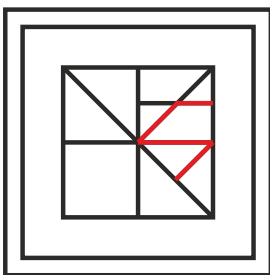

Hence, the **first option** is correct.

**Q.  
136**

**Directions:** Select the option figure in which the given figure is embedded. (rotation is NOT allowed)

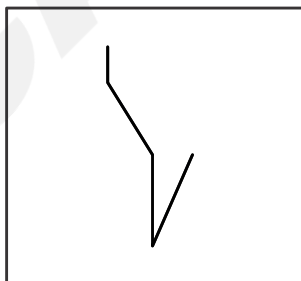

**Option 1:**

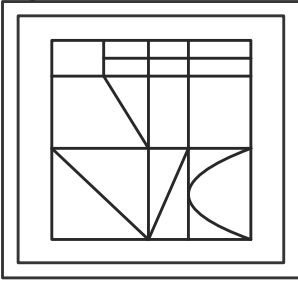

**Option 2:**

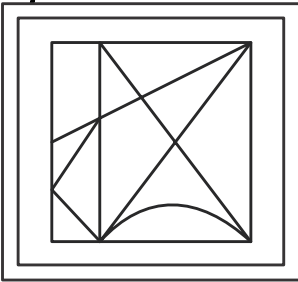

**Option 3:**

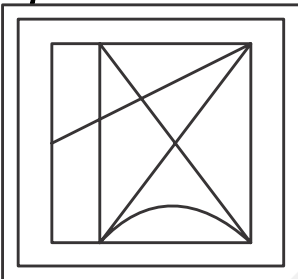

**Option 4:**

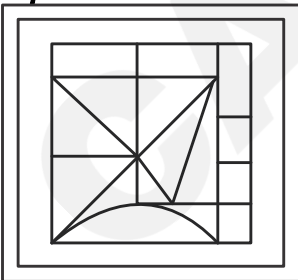

**Correct Answer:**

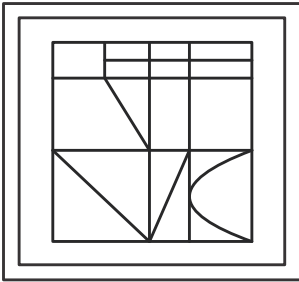

**Solution:**

Since the rotation is restricted. So, the embedded figure will have the same orientation as the main figure. By comparison of all the option figures, the given question figure is embedded only in the first option figure.

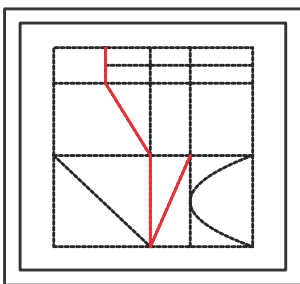

Hence, the **first option** is correct.

**Q.  
137**

**Directions:** Select the option figure in which the given figure is embedded. (rotation is NOT allowed)

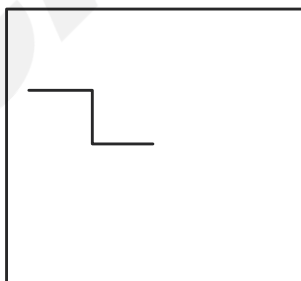

**Option 1:**

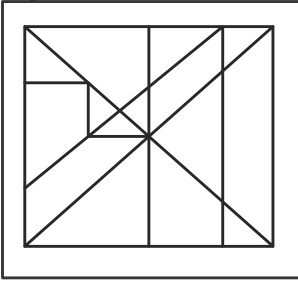

**Option 2:**

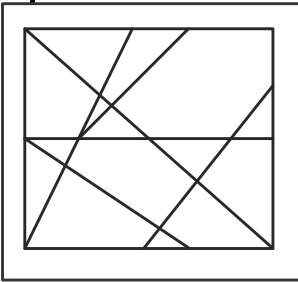

**Option 3:**

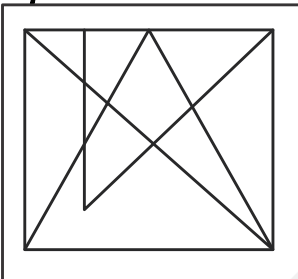

**Option 4:**

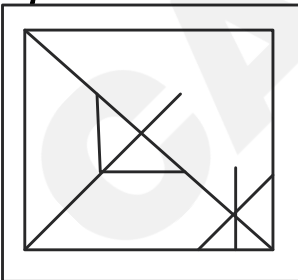

**Correct Answer:**

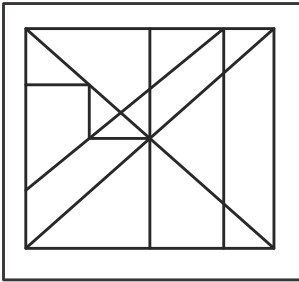

**Solution:**

Since the rotation is restricted. So, the embedded figure will have the same orientation as the main figure. By comparison of all the option figures, the given question figure is embedded only in the first option figure.

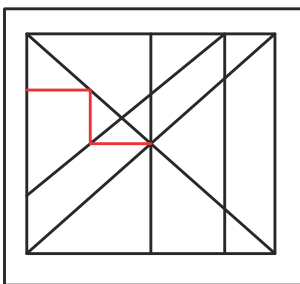

Hence, the **first option** is correct.

**Q.  
138**

**Directions:** Select the option figure in which the given figure is embedded. (Rotation is NOT allowed)

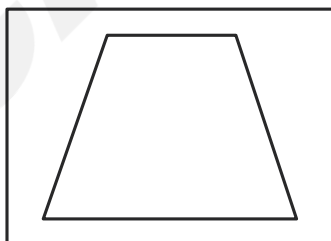

**Option 1:**

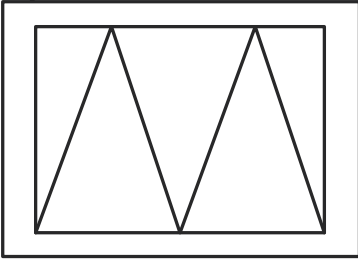

**Option 2:**

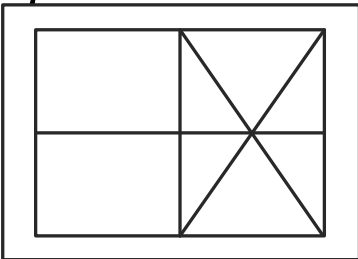

**Option 3:**

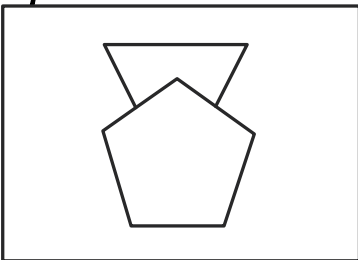

**Option 4:**

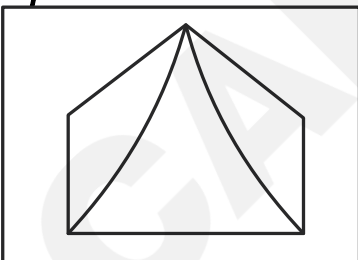

**Correct Answer:**

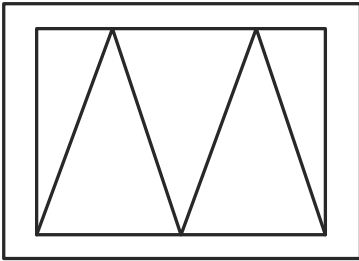

**Solution:**

Since the rotation is restricted. So, the embedded figure will have the same orientation as the main figure. By comparison of all the option figures, the given question figure is embedded only in the first option figure.

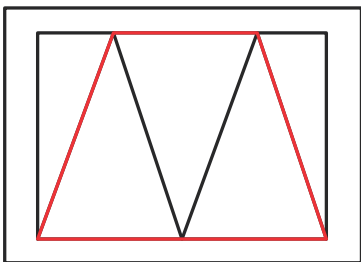

Hence, the **first option** is correct.

**Q.  
139**

**Directions:** Select the option figure in which the given figure is embedded. (rotation is NOT allowed)

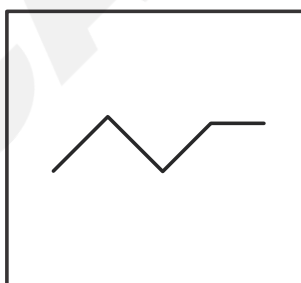

**Option 1:**

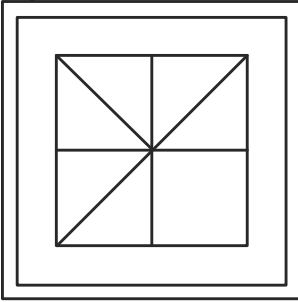

**Option 2:**

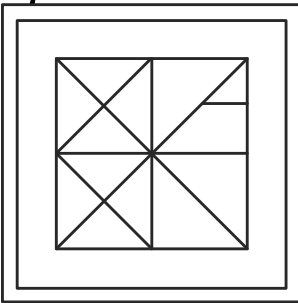

**Option 3:**

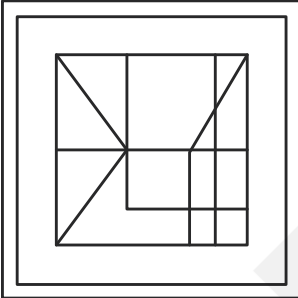

**Option 4:**

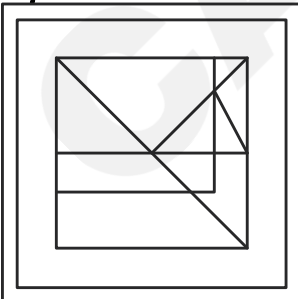

**Correct Answer:**

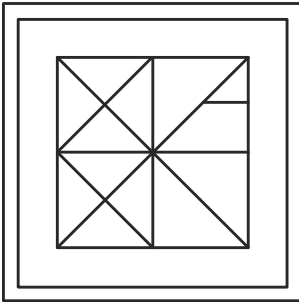

**Solution:**

Since the rotation is restricted. So, the embedded figure will have the same orientation as the main figure. By comparison of all the option figures, the given question figure is embedded only in the second option figure.

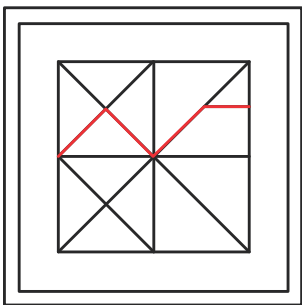

Hence, the **second option** is correct.

**Q.  
140**

**Directions:** Select the option figure in which the given figure is embedded. (rotation is NOT allowed)

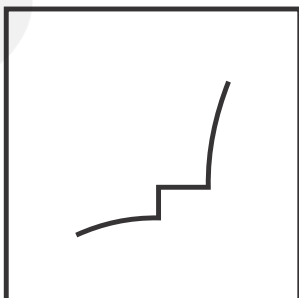

**Option 1:**

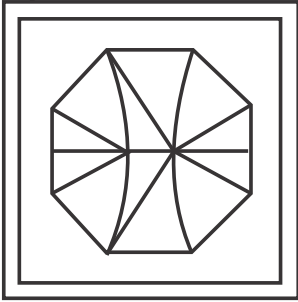

**Option 2:**

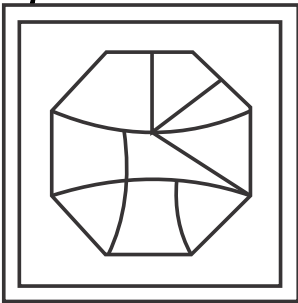

**Option 3:**

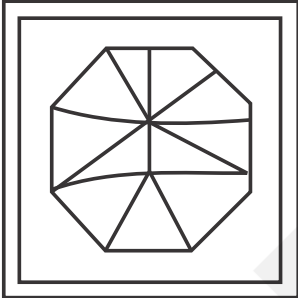

**Option 4:**

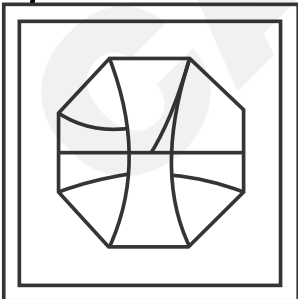

**Correct Answer:**

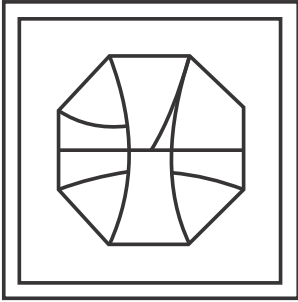

**Solution:**

Since the rotation is restricted. So, the embedded figure will have the same orientation as the main figure. By comparison of all the option figures, the given question figure is embedded only in the fourth option figure.

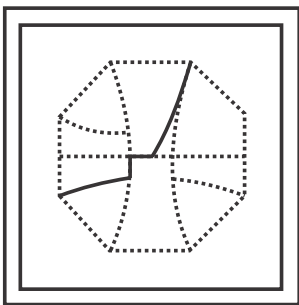

Hence, the **fourth option** is correct.

**Q.  
141**

**Directions:** Select the option figure in which the given figure is embedded. (rotation is NOT allowed)

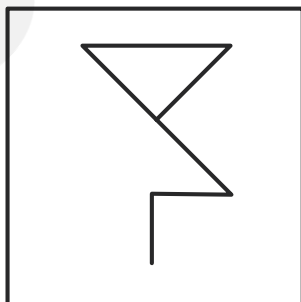

**Option 1:**

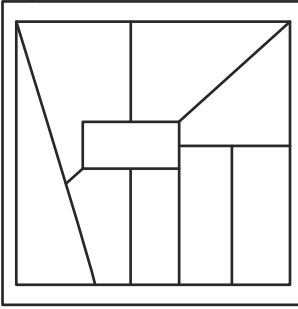

**Option 2:**

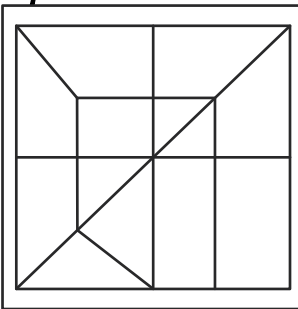

**Option 3:**

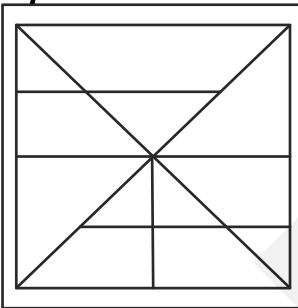

**Option 4:**

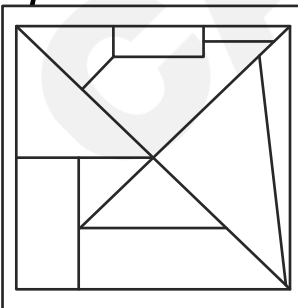

**Correct Answer:**

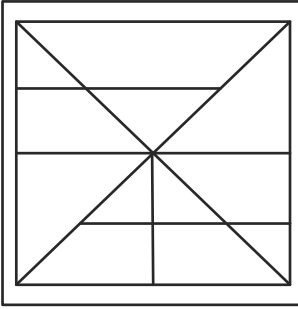

**Solution:**

Since the rotation is restricted. So, the embedded figure will have the same orientation as the main figure. By comparison of all the option figures, the given question figure is embedded only in the third option figure.

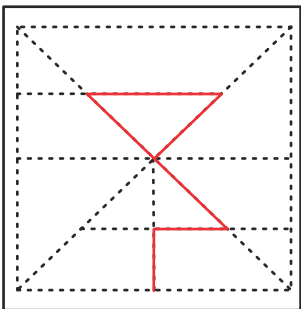

Hence, the **third option** is correct.

**Q.  
142**

**Directions:** Select the option figure in which the given figure is embedded. (rotation is NOT allowed)



*Option 1:*

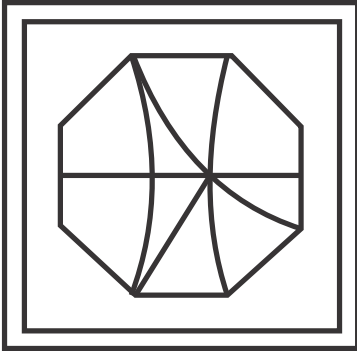

*Option 2:*

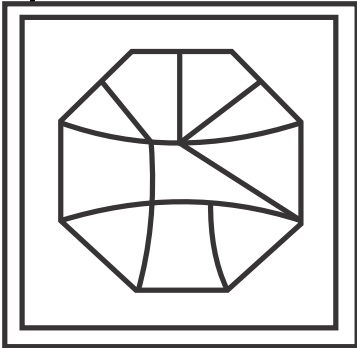

*Option 3:*

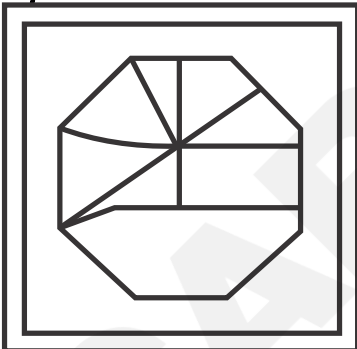

**Option 4:**

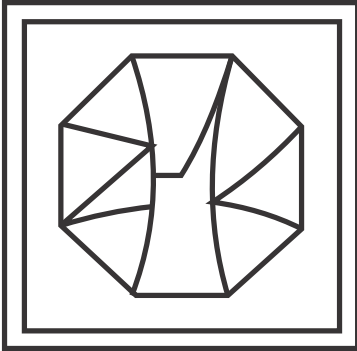

**Correct Answer:**

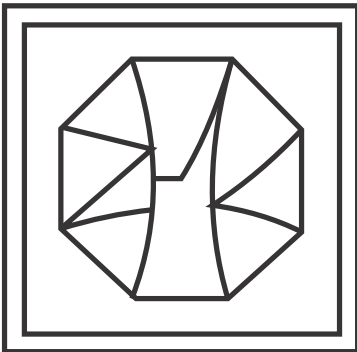

**Solution:**

Since the rotation is restricted. So, the embedded figure will have the same orientation as the main figure. By comparison of the question figure with all the option figures, the given question figure is embedded only in the fourth option figure.

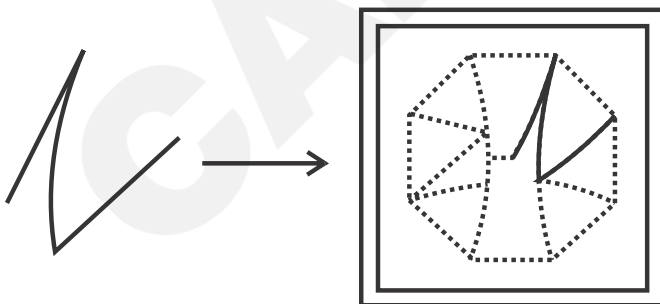

Hence, the **fourth option** is correct.

Q.  
143

**Directions:** Select the option figure in which the given figure is embedded. (rotation is NOT allowed)

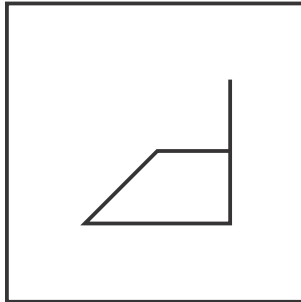

*Option 1:*

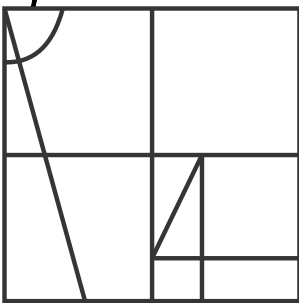

*Option 2:*

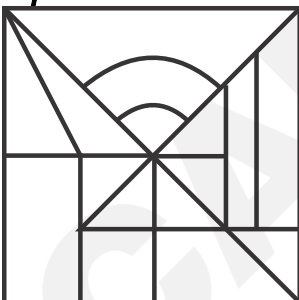

**Option 3:**

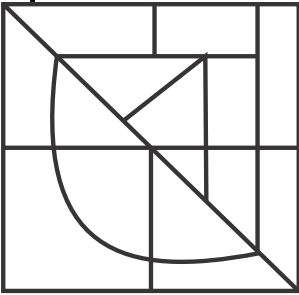

**Option 4:**

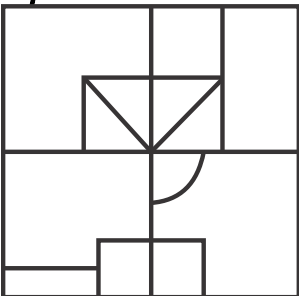

**Correct Answer:**

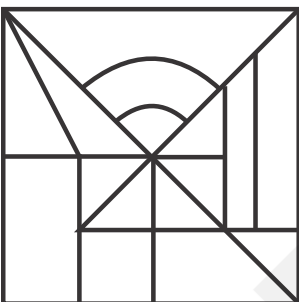

**Solution:**

Since the rotation is restricted. So, the embedded figure will have the same orientation as the main figure. By comparison of the question figure with all the option figures, the given question figure is embedded only in the second option figure.

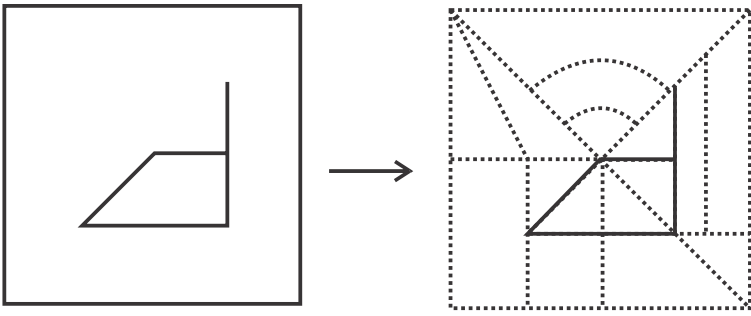

Hence, the **second option** is correct.

**Q.  
144**

**Directions:** Select the option figure in which the given figure is embedded. (rotation is NOT allowed)

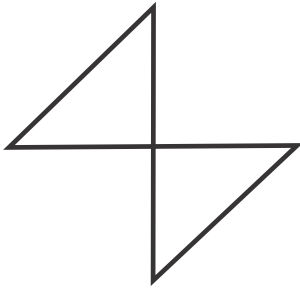

**Option 1:**

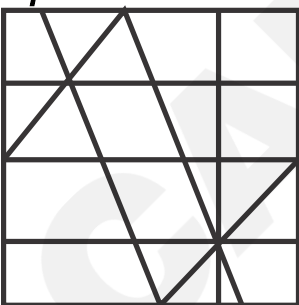

*Option 2:*

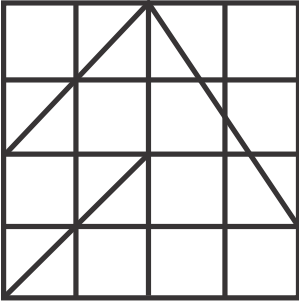

*Option 3:*

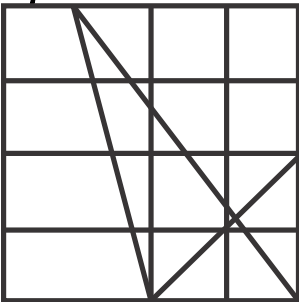

*Option 4:*

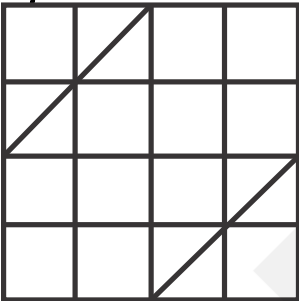

*Correct Answer:*

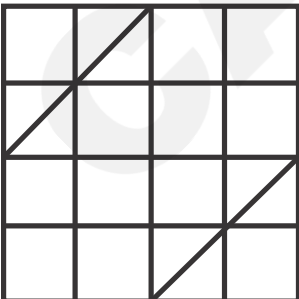

**Solution:**

Since the rotation is restricted. So, the embedded figure will have the same orientation as the main figure. By comparison of the question figure with all the option figures, the given question figure is embedded only in the fourth option figure.

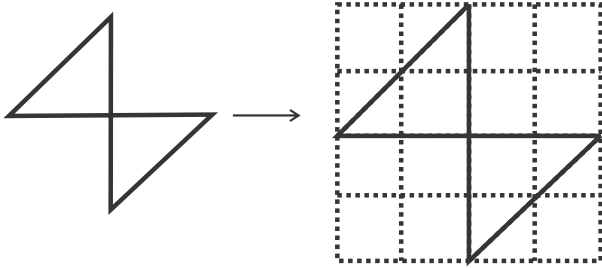

Hence, the **fourth option** is correct.

**Q.**  
**145**

**Directions:** Select the option figure in which the given figure is embedded. (rotation is NOT allowed)



*Option 1:*

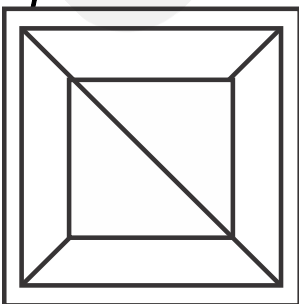

*Option 2:*

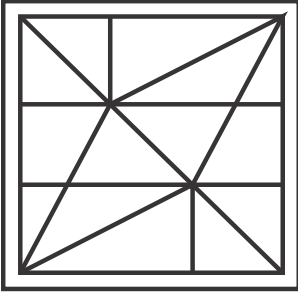

*Option 3:*

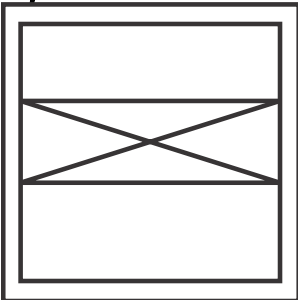

*Option 4:*

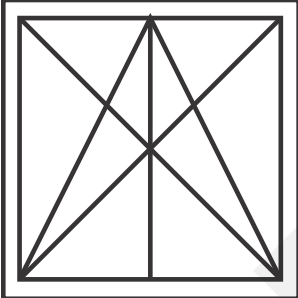

*Correct Answer:*

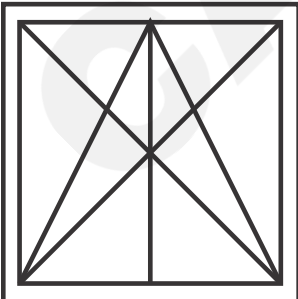

**Solution:**

Since the rotation is restricted. So, the embedded figure will have the same orientation as the main figure. By comparison of the question figure with all the option figures, the given question figure is embedded only in the fourth option figure.

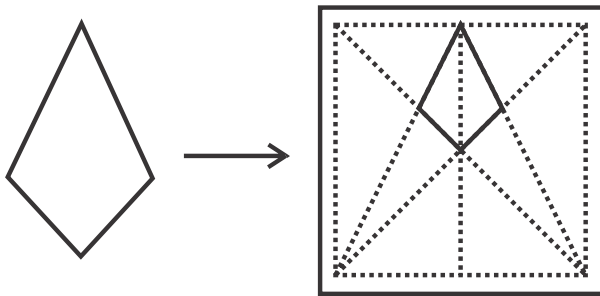

Hence, the **fourth option** is correct.

**Q.**  
**146**

**Directions:** Select the option figure in which the given figure (X) is embedded as its part (rotation is NOT allowed).

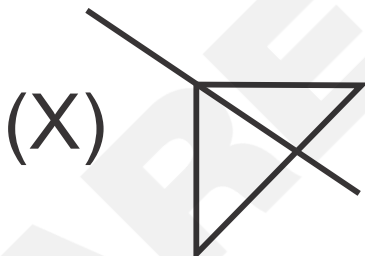

**Option 1:**

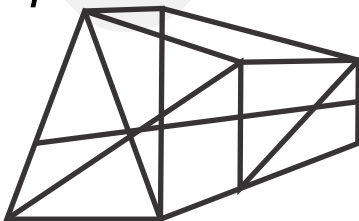

**Option 2:**

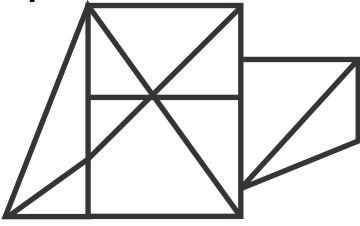

**Option 3:**

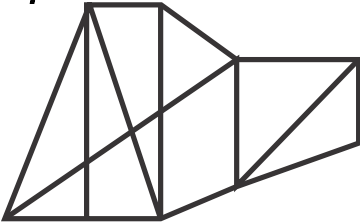

**Option 4:**

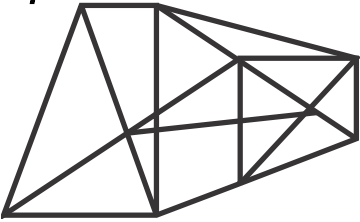

**Correct Answer:**

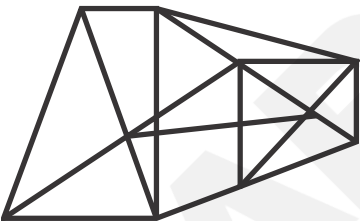

**Solution:**

Since the rotation is restricted. So, the embedded figure will have the same orientation as the main figure. By comparison of the question figure with all the option figures, the given question figure is embedded only in the fourth option figure.

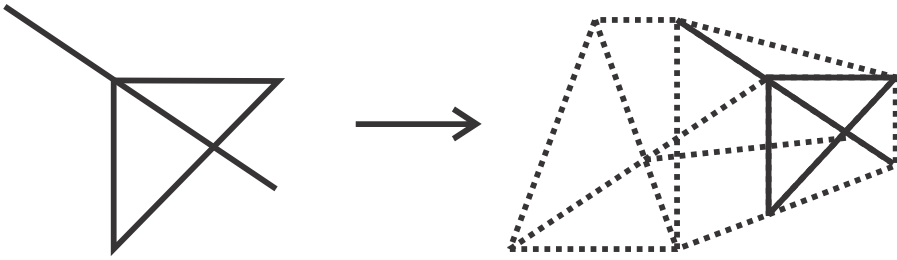

Hence, the **fourth option** is correct.

**Q.  
147**

**Directions:** Select the option figure in which the given figure is embedded as its part (rotation is NOT allowed).

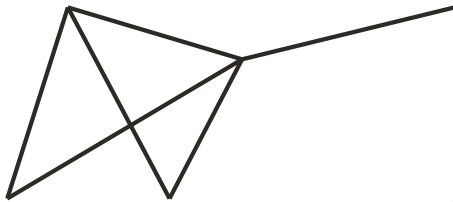

**Option 1:**

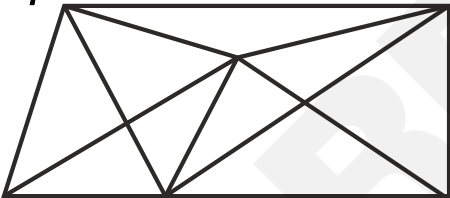

**Option 2:**

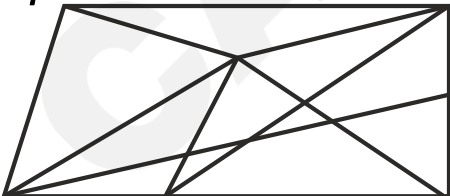

**Option 3:**

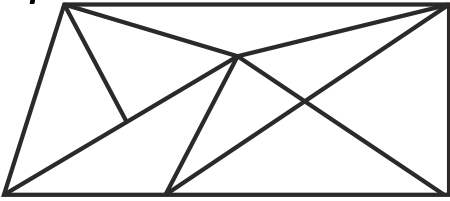

**Option 4:**

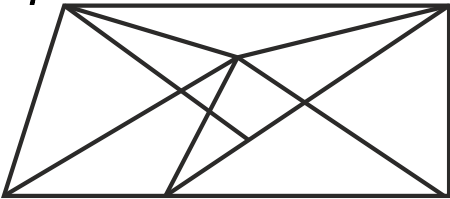

**Correct Answer:**

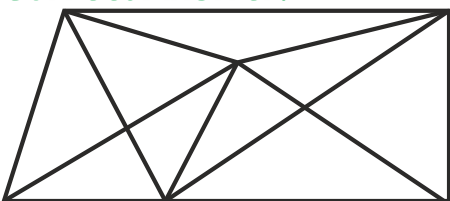

**Solution:**

Since the rotation is restricted. So, the embedded figure will have the same orientation as the main figure. By comparison of the question figure with all the option figures, the given question figure is embedded only in the first option figure.

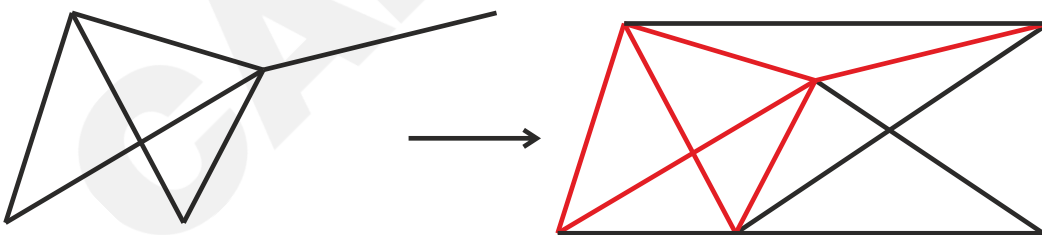

Hence, the **first option** is correct.

Q.  
148

**Directions:** From the given answer figures, select the one in which the question figure is hidden/embedded.

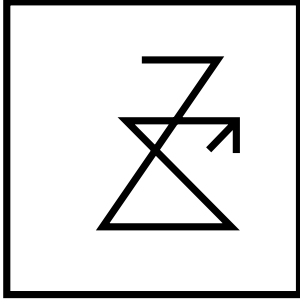

*Option 1:*

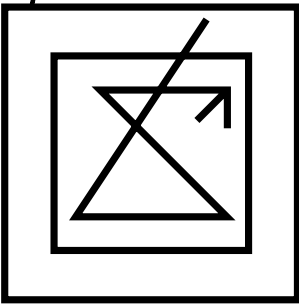

*Option 2:*

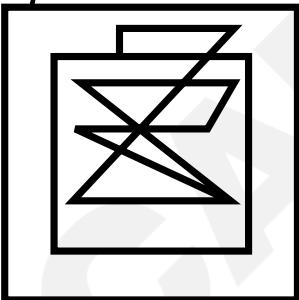

*Option 3:*

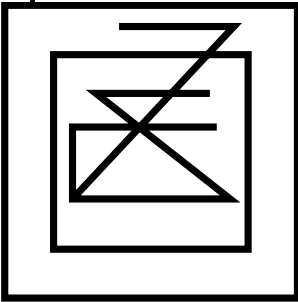

*Option 4:*

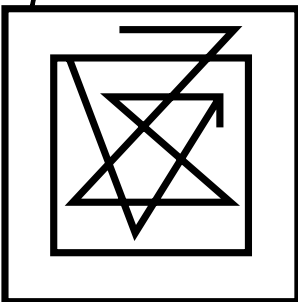

*Correct Answer:*

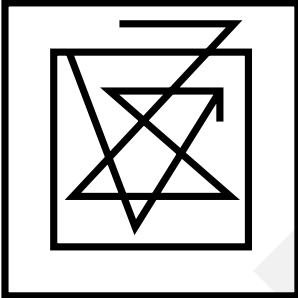

**Solution:**

Because there is no restriction on the rotation of the figure, we will check all the possible orientations of the question figure in which of the given option figures it can fit itself. By comparison of all option figures, the question figure is embedded only in the fourth option figure.

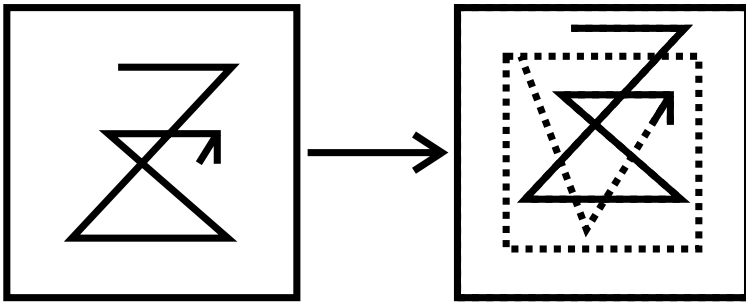

Hence, the **fourth option** is correct.

Q.  
149

**Directions:** From the given answer figures, select the one in which the question figure is hidden/embedded.

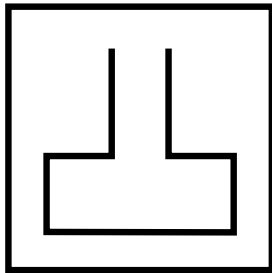

*Option 1:*

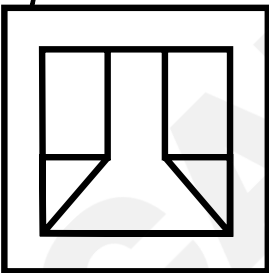

*Option 2:*

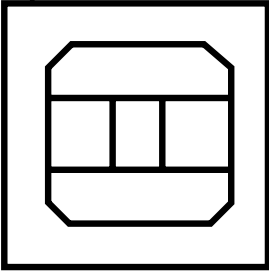

*Option 3:*

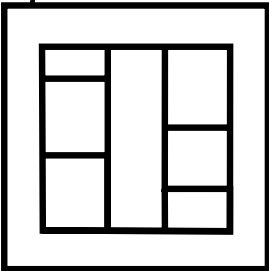

*Option 4:*

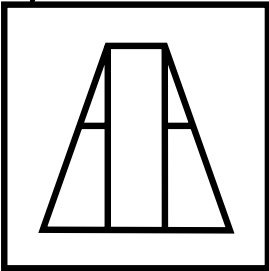

*Correct Answer:*

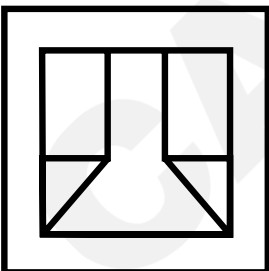

**Solution:**

Because there is no restriction on the rotation of the figure, we will check all the possible orientations of the question figure in which of the given option figures it can fit itself. By comparison of

all option figures, the question figure is embedded only in the first option figure.

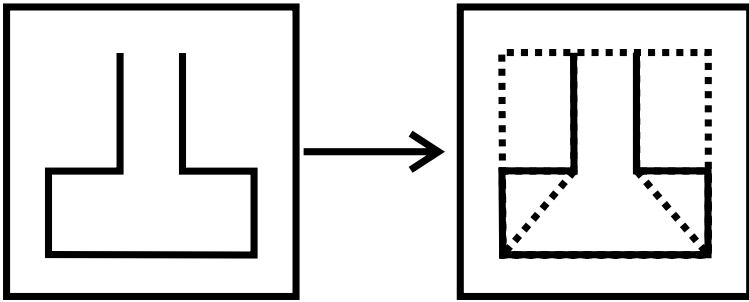

Hence, the **first option** is correct.

CAREERS360